



Network Video Recorder

User's Manual

V1.2.0

Cybersecurity Recommendations

Mandatory actions to be taken towards cybersecurity

1. Change Passwords and Use Strong Passwords:

The number one reason systems get “hacked” is due to having weak or default passwords. It is recommended to change default passwords immediately and choose a strong password whenever possible. A strong password should be made up of at least 8 characters and a combination of special characters, numbers, and upper and lower case letters.

2. Update Firmware

As is standard procedure in the tech-industry, we recommend keeping NVR, DVR, and IP camera firmware up-to-date to ensure the system is current with the latest security patches and fixes.

“Nice to have” recommendations to improve your network security

1. Change Passwords Regularly

Regularly change the credentials to your devices to help ensure that only authorized users are able to access the system.

2. Change Default HTTP and TCP Ports:

- Change default HTTP and TCP ports for systems. These are the two ports used to communicate and to view video feeds remotely.
- These ports can be changed to any set of numbers between 1025-65535. Avoiding the default ports reduces the risk of outsiders being able to guess which ports you are using.

3. Enable HTTPS/SSL:

Set up an SSL Certificate to enable HTTPS. This will encrypt all communication between your devices and recorder.

4. Enable IP Filter:

Enabling your IP filter will prevent everyone, except those with specified IP addresses, from accessing the system.

5. Change ONVIF Password:

On older IP Camera firmware, the ONVIF password does not change when you change the system’s credentials. You will need to either update the camera’s firmware to the latest revision or manually change the ONVIF password.

6. Forward Only Ports You Need:

- Only forward the HTTP and TCP ports that you need to use. Do not forward a huge range of numbers to the device. Do not DMZ the device's IP address.
- You do not need to forward any ports for individual cameras if they are all connected to a recorder on site; just the NVR is needed.

7. Disable Auto-Login on SmartPSS:

Those using SmartPSS to view their system and on a computer that is used by multiple people should disable auto-login. This adds a layer of security to prevent users without the appropriate credentials from accessing the system.

8. Use a Different Username and Password for SmartPSS:

In the event that your social media, bank, email, etc. account is compromised, you would not want someone collecting those passwords and trying them out on your video surveillance system. Using a different username and password for your security system will make it more difficult for someone to guess

their way into your system.

9. Limit Features of Guest Accounts:

If your system is set up for multiple users, ensure that each user only has rights to features and functions they need to use to perform their job.

10. UPnP:

- UPnP will automatically try to forward ports in your router or modem. Normally this would be a good thing. However, if your system automatically forwards the ports and you leave the credentials defaulted, you may end up with unwanted visitors.
- If you manually forwarded the HTTP and TCP ports in your router/modem, this feature should be turned off regardless. Disabling UPnP is recommended when the function is not used in real applications.

11. SNMP:

Disable SNMP if you are not using it. If you are using SNMP, you should do so only temporarily, for tracing and testing purposes only.

12. Multicast:

Multicast is used to share video streams between two recorders. Currently there are no known issues involving Multicast, but if you are not using this feature, deactivation can enhance your network security.

13. Check the Log:

If you suspect that someone has gained unauthorized access to your system, you can check the system log. The system log will show you which IP addresses were used to login to your system and what was accessed.

14. Physically Lock Down the Device:

Ideally, you want to prevent any unauthorized physical access to your system. The best way to achieve this is to install the recorder in a lockbox, locking server rack, or in a room that is behind a lock and key.

15. Connect IP Cameras to the PoE Ports on the Back of an NVR:

Cameras connected to the PoE ports on the back of an NVR are isolated from the outside world and cannot be accessed directly.

16. Isolate NVR and IP Camera Network

The network your NVR and IP camera resides on should not be the same network as your public computer network. This will prevent any visitors or unwanted guests from getting access to the same network the security system needs in order to function properly.

FCC Information



Changes or modifications not expressly approved by the party responsible for compliance could void the user's authority to operate the equipment.

FCC conditions:

This device complies with part 15 of the FCC Rules. Operation is subject to the following two conditions:

- This device may not cause harmful interference.
- This device must accept any interference received, including interference that may cause undesired operation.

FCC compliance:

This equipment has been tested and found to comply with the limits for a digital device, pursuant to part 15 of the FCC Rules. This equipment generate, uses and can radiate radio frequency energy and, if not installed and used in accordance with the guide, may cause harmful interference to radio communication.

- For class A device, these limits are designed to provide reasonable protection against harmful interference in a commercial environment. Operation of this equipment in a residential area is likely to cause harmful interference in which case the user will be required to correct the interference at his own expense.
- For class B device, these limits are designed to provide reasonable protection against harmful interference in a residential installation. However, there is no guarantee that interference will not occur in a particular installation. If this equipment does cause harmful interference to radio or television reception, which can be determined by turning the equipment off and on, the user is encouraged to try to correct the interference by one or more of the following measures:
 - Reorient or relocate the receiving antenna.
 - Increase the separation between the equipment and receiver.
 - Connect the equipment into an outlet on a circuit different from that to which the receiver is connected.
 - Consult the dealer or an experienced radio/TV technician for help.

Table of Contents

1	Features and Specifications	1
1.1	Overview.....	1
1.2	Features.....	1
1.3	Specifications.....	2
1.3.1	NVR1A-4P/1A-8P Series.....	2
1.3.2	NVR1AHS/1AHS-4P/1AHS-8P Series.....	4
1.3.3	NVR2A16 Series	6
1.3.4	NVR1B04/L, NVR1B08/L, NVR1B04-4P/L Series.....	8
1.3.5	NVR1B04HS/L, NVR1B08HS/L, NVR1B04HS-4P/L Series.....	10
1.3.6	NVR1B04, NVR1B08, NVR1B04-4P Series	12
1.3.7	NVR1B04HS, NVR1B08HS, NVR1B04HS-4P, NVR1B08HS-8P Series	13
1.3.8	NVR2B16 Series	15
1.3.9	NVR1BHC/E, NVR1BHC-4P/E Series	17
1.3.10	NVR1BHS-8P/E Series.....	18
2	Front Panel and Rear Panel.....	21
2.1	Front Panel.....	21
2.1.1	NVR1A-4P, NVR1A-8P, NVR1B04 (/L), NVR1B08 (/L), NVR1B04-4P (/L) Series.....	21
2.1.2	NVR1AHS, NVR1AHS-4P, NVR1AHS-8P, NVR2A16, NVR1B04HS (/L), NVR1B08HS (/L), NVR1B04HS-4P (/L), NVR1B08HS-8P, NVR2B16 Series.....	21
2.1.3	NVR1BHC/E, NVR1BHC-4P/E, NVR1BHS-8P/E Series	22
2.2	Rear Panel	22
2.2.1	NVR1B04/L, NVR1B08/L, NVR1B04-4P/L Series.....	22
2.2.2	NVR1A-4P, NVR1A-8P, NVR1B04, NVR1B08, NVR1B04-4P Series	22
2.2.3	NVR1B04HS/L, NVR1B08HS/L, NVR1B04HS-4P/L Series	24
2.2.4	NVR1AHS, NVR1AHS-4P, NVR1AHS-8P, NVR1B04HS, NVR1B08HS, NVR1B04HS-4P, NVR1B08HS-8P Series.....	25
2.2.5	NVR2A16, NVR2B16 Series.....	26
2.2.6	NVR1BHC/E, NVR1BHC-4P/E, NVR1BHS-8P/E Series	27
2.3	Bidirectional talk	28
2.3.1	Device-end to PC-end	29
2.3.2	PC-end to the device-end	29
2.4	Mouse Operation.....	29
3	Device Installation	31
3.1	Device Installation Diagrams.....	31
3.2	Check Unpacked NVR.....	31
3.3	About Front Panel and Rear Panel.....	31
3.4	HDD Installation.....	32
3.4.1	NVR1A-4P, NVR1A-8P, NVR1B04 (/L), NVR1B08 (/L), NVR1B04-4P (/L) Series.....	32
3.4.2	NVR1AHS, NVR1AHS-4P, NVR1AHS-8P, NVR1B04HS (/L), NVR1B08HS (/L), NVR1B04HS-4P (/L), NVR1B08HS-8P, NVR2A16, NVR2B16, NVR1BHC/E, NVR1BHC-4P/E, NVR1BHS-8P/E Series.....	34
3.5	Connection Sample.....	36
3.5.1	NVR1A-4P, NVR1A-8P, NVR1B04 (/L), NVR1B08 (/L), NVR1B04-4P (/L) Series.....	36

3.5.2	NVR1AHS, NVR1AHS-4P, NVR1AHS-8P, NVR1B04HS (L), NVR1B08HS (L), NVR1B04HS-4P (L), NVR1B08HS-8P, NVR1BHC/E, NVR1BHC-4P/E, NVR1BHS-8P/E Series	36
3.5.3	NVR2A16, NVR2B16 Series	37
4	Local Basic Operation	39
4.1	Getting Started	39
4.1.1	Boot up and Shut down	39
4.1.2	Device Initialization	39
4.1.3	Reset Password	42
4.1.4	Quick Settings	46
4.2	Camera	66
4.2.1	Connection	66
4.2.2	Remote Device Initialization	67
4.2.3	Short-Cut Menu to Register Camera	72
4.2.4	Image	72
4.2.5	Encode	74
4.2.6	Channel Name	78
4.2.7	Remote Upgrade	79
4.2.8	Remote Device Info	80
4.3	Preview	81
4.3.1	Preview	81
4.3.2	Preview Control Interface	82
4.3.3	Right Click Menu	84
4.3.4	Edit View (Sequence)	84
4.3.5	Preview Display Effect Setup	86
4.4	PTZ	88
4.5	Record File	94
4.6	Playback and Search	94
4.6.1	Instant Playback	94
4.6.2	Search Interface	94
4.6.3	Smart Search Playback	99
4.6.4	Mark Playback	99
4.6.5	Playback Image	101
4.6.6	File List	101
4.6.7	Other Aux Functions	103
4.7	Event Manager	103
4.7.1	Video Detect	103
4.7.2	Alarm Settings	109
4.7.3	Abnormality	113
4.8	Network	115
4.8.1	Network Settings	115
4.8.2	Network Test	122
4.9	Storage	123
4.9.1	Basic	123
4.9.2	Schedule	124
4.9.3	HDD	124
4.9.4	Record Control	125

4.9.5	HDD Information	125
4.9.6	HDD Detect	127
4.10	Device Maintenance and Manager	130
4.10.1	Account	130
4.10.2	System Info	138
4.10.3	Security	140
4.10.4	Auto Maintain	142
4.10.5	Backup	143
4.10.6	Default	147
4.10.7	Upgrade	148
4.11	Logout /Shutdown/Restart	150
5	Web Operation	152
5.1	General Introduction	152
5.1.1	Preparation	152
5.2	Device Initialization	152
5.3	Log in	154
5.4	Reset Password	155
5.5	LAN Mode	157
5.6	Real-time Monitor	159
5.7	PTZ	160
5.8	Image/Alarm-out	161
5.8.1	Image	161
5.9	WAN Login	162
5.10	Setup	163
5.10.1	Camera	163
5.10.2	Network	178
5.10.3	Event	189
5.10.4	Storage	197
5.10.5	System	201
5.11	Information	215
5.11.1	Version	215
5.11.2	Log	215
5.11.3	Online User	216
5.11.4	HDD	216
5.12	Playback	217
5.12.1	Search Record	217
5.12.2	File List	218
5.12.3	Playback	218
5.12.4	Download	219
5.12.5	Load more	219
5.13	Alarm	222
5.14	Log out	223
5.15	Un-install Web Control	223
6	Glossary	224
7	FAQ	225
8	Appendix A HDD Capacity Calculation	230









9 Appendix B Compatible Network Camera List.....231

General

This user's manual (hereinafter referred to be "the Manual") introduces the functions and operations of the NVR (EZ-IP 2.0) devices (hereinafter referred to be "the Device").

Safety Instructions

The following categorized signal words with defined meaning might appear in the Manual.

Signal Words	Meaning
 DANGER	Indicates a high potential hazard which, if not avoided, will result in death or serious injury.
 WARNING	Indicates a medium or low potential hazard which, if not avoided, could result in slight or moderate injury.
 CAUTION	Indicates a potential risk which, if not avoided, could result in property damage, data loss, lower performance, or unpredictable result.
 ELECTRICITY	Indicates dangerous high voltage. Take care to avoid coming into contact with electricity.
 LASER BEAM	Indicates a laser radiation hazard. Take care to avoid exposure to a laser beam.
 ESD	Electrostatic Sensitive Devices. Indicates a device that is sensitive to electrostatic discharge.
 TIPS	Provides methods to help you solve a problem or save you time.
 NOTE	Provides additional information as the emphasis and supplement to the text.

Revision History

No.	Version	Revision Content	Release Time
-----	---------	------------------	--------------

No.	Version	Revision Content	Release Time
1	V1.0.0	First Release.	November, 2017
2	V1.1.0		April, 2018
3	V1.1.1	Add privacy protection notice.	May, 2018
4	V1.1.2	<ul style="list-style-type: none"> ● Add FCC. ● Add new models: NVR1A-4P/1A-8P/1AHS/1AHS-4P/1AHS-8P/2A16. 	July, 2018
5	V1.2.0	<ul style="list-style-type: none"> ● Add models: NVR1BHC/E, NVR1BHC-4P/E, NVR1BHS-8P/E. ● Update relevant information about the added models. ● GDPR update. 	August, 2018

Privacy Protection Notice

As the device user or data controller, you might collect personal data of others such as face, fingerprints, car plate number, Email address, phone number, GPS and so on. You need to be in compliance with the local privacy protection laws and regulations to protect the legitimate rights and interests of other people by implementing measures including but not limited to: providing clear and visible identification to inform data subject the existence of surveillance area and providing related contact.

About the Manual

- The Manual is for reference only. If there is inconsistency between the Manual and the actual product, the actual product shall prevail.
- We are not liable for any loss caused by the operations that do not comply with the Manual.
- The Manual would be updated according to the latest laws and regulations of related regions. For detailed information, see the paper manual, CD-ROM, QR code or our official website. If there is inconsistency between paper manual and the electronic version, the electronic version shall prevail.
- All the designs and software are subject to change without prior written notice. The product updates might cause some differences between the actual product and the Manual. Please contact the customer service for the latest program and supplementary documentation.
- There still might be deviation in technical data, functions and operations description, or errors in print. If there is any doubt or dispute, please refer to our final explanation.
- Upgrade the reader software or try other mainstream reader software if the Guide (in PDF format) cannot be opened.
- All trademarks, registered trademarks and the company names in the Manual are the properties of their respective owners.

- Please visit our website, contact the supplier or customer service if there is any problem occurred when using the device.
- If there is any uncertainty or controversy, please refer to our final explanation.

Important Safeguards and Warnings

The following description is the correct application method of the device. Read the manual carefully before use to prevent danger and property loss. Strictly conform to the manual during application and keep it properly after reading.

Operating Requirement

- Don't place and install the device in an area exposed to direct sunlight or near heat generating device.
- Don't install the device in a humid, dusty or fuliginous area.
- Keep its horizontal installation, or install it at stable places, and prevent it from falling.
- Don't drip or splash liquids onto the device; don't put on the device anything filled with liquids, in order to prevent liquids from flowing into the device.
- Install the device at well-ventilated places; don't block its ventilation opening.
- Use the device only within rated input and output range.
- Don't dismantle the device arbitrarily.
- Transport, use and store the device within allowed humidity and temperature range.

Power Requirement

- Make sure to use batteries according to requirements; otherwise, it may result in fire, explosion or burning risks of batteries!
- To replace batteries, only the same type of batteries can be used.
- The product shall use electric wires (power wires) recommended by this area, which shall be used within its rated specification.
- Make sure to use standard power adapter matched with this device. Otherwise, the user shall undertake resulting personnel injuries or device damages.
- Use power supply that meets SELV (safety extra low voltage) requirements, and supply power with rated voltage that conforms to Limited Power Source in IEC60950-1. For specific power supply requirements, please refer to device labels.
- Products with category I structure shall be connected to grid power output socket, which is equipped with protective grounding.
- Appliance coupler is a disconnecting device. During normal use, please keep an angle that facilitates operation.

1 Features and Specifications

1.1 Overview

This series NVR is an entry-level network video recorder. This series product support local preview, multiple-window display, recorded file local storage, remote control and mouse shortcut menu operation, and remote management and control function.

This series product supports center storage, front-end storage and client-end storage. The monitor zone in the front-end can be set in anywhere. Working with other front-end devices such as IPC, this series product can establish a strong surveillance network via the CMS. In the network system, there is only one network cable from the monitor center to the monitor zone in the whole network. There is no audio/video cable from the monitor center to the monitor zone. The whole project is featuring of simple connection, low-cost, low maintenance work.

This series NVR can be widely used in many areas such as public security, water conservancy, transportation and education.

1.2 Features

Cloud Upgrade	<ul style="list-style-type: none">• For the NVR connected with the Internet, it supports online upgrade to update applications.
Real-time Surveillance	<ul style="list-style-type: none">• VGA, HDMI port. Connect to monitor to realize real-time surveillance.• Short-cut menu when preview.• Support popular PTZ decoder control protocols. Support preset, tour and pattern.
Playback	<ul style="list-style-type: none">• Support each channel real-time record independently, and at the same time it can support search, forward play, network monitor, record search, download and etc.• Support various playback modes: slow play, fast play, backward play and frame by frame play.• Support time title overlay so that you can view event accurate occurred time• Support specified zone enlargement.
User Management	<ul style="list-style-type: none">• Each group has different management powers that can be edited freely. Every user belongs to an exclusive group.
Storage	<ul style="list-style-type: none">• Via corresponding setup (such as alarm setup and schedule setup), you can backup related audio/video data in the network video recorder.• Support Web record and record local video and storage the file in the client end.
Network Monitor	<ul style="list-style-type: none">• Through network, sending audio/video data compressed by IPC to client-ends, then the data will be decompressed and display.• Support max 128 connections at the same time.• Transmit audio/video data by HTTP, TCP, UDP, RTP/RTCP and etc.• Support WEB access in WAN/LAN.
Window Split	<ul style="list-style-type: none">• Adopt the video compression and digital process to show several windows in one monitor. Support 1/4/8/9-window display (depending on

	product channel amount) when preview and 1/4/9/16-window (depending on product channel amount) display when playback.
Record	<ul style="list-style-type: none"> Support normal/motion detect/alarm record function. Save the recorded files in the HDD, USB device, client-end PC, or network storage server. You can search or playback the saved files at the local-end or via the Web/USB device.
Backup	<ul style="list-style-type: none"> Support network backup, USB2.0 record backup function, the recorded files can be saved in network storage server, peripheral USB2.0 device, burner and etc.
Network Management	<ul style="list-style-type: none"> Supervise NVR configuration and control power via Ethernet. Support management via WEB.
Peripheral Equipment Management	<ul style="list-style-type: none"> Support peripheral equipment management such as protocol setup and port connection.
Auxiliary	<ul style="list-style-type: none"> Support switch between NTSC and PAL. Support real-time system resources information and running statistics display. Support log file. Local GUI output. Shortcut menu operation via mouse. Play the video/audio from the network camera or NVS remotely.

1.3 Specifications

1.3.1 NVR1A-4P/1A-8P Series

Model		NVR1A-4P Series	NVR1A-8P Series
System	System Resources	4/8-ch series product support 4/8 HD connection respectively. Total bandwidth supports 80Mbps.	
	OS	Embedded Linux real-time operation system	
	Operation Interface	WEB/Local GUI	
Decode	Video Decode Type	Smart H.264+/H.264	
	Decode Capability	Max 4-ch 1080P 30fps or 8-ch 720P 30fps or 8-ch D1 30fps	
Video	Video Input	4/8-ch network compression video input	
	Video Output	1-channel VGA analog video output	

Model		NVR1A-4P Series	NVR1A-8P Series
	HDMI	1-ch HDMI output. Version number is 1.4	
	Window Split	1/4/8/9-window	
Audio	Audio Input	1-ch bidirectional talk input	
	Audio Output	1-ch bidirectional talk output	
	Audio Compression Standard	G.711a	
Alarm	Alarm Input	N/A	
	Alarm Output	N/A	
Function	Storage	1 built-in SATA port	
	Multiple-Channel Playback	Max 8-channel D1 or 8-channel 720P or 4-channel 1080P playback	
Port and Indicator	RS232 Port	N/A	
	RS485 Port	N/A	
	USB Port	2 peripheral USB2.0 ports.	
	Network Connection	1 RJ45 10/100Mbps self-adaptive Ethernet port.	
	PoE	4	8
	Power Port	1 power socket. Power adapter power supplying mode. DC 48V power.	1 power socket. Power adapter power supplying mode. DC 48V power.

Model		NVR1A-4P Series	NVR1A-8P Series
	Power Button	N/A	
	Power On-off Button	N/A	
	IR Receiver Window	N/A	
	Clock	Built-in clock.	
	Indicator Light	One power status indicator light. One network status indicator light. One HDD status indicator light.	
General	Power Consumption	<10W (No HDD)	
	Working Temperature	- 10°C ~ + 55°C	
	Working Humidity	10%~90%	
	Air pressure	86kPa~106kPa	
	Dimension	205mm×206.75mm×45.2mm	425mm×95mm×260mm
	Weight	0.5kg~2kg (No HDD)	
	Installation Mode	Desk installation	

1.3.2 NVR1AHS/1AHS-4P/1AHS-8P Series

Model		NVR1AHS Series	NVR1AHS-4P Series	NVR1AHS-8P Series
System	System Resources	4/8-ch series product support 4/8 HD connection respectively. Total bandwidth supports 80Mbps.	4/8-ch series product support 4/8 HD connection respectively. Total bandwidth supports 80Mbps.	
	OS	Embedded Linux real-time operation system		
	Operation Interface	WEB/Local GUI		

Model		NVR1AHS Series	NVR1AHS-4P Series	NVR1AHS-8P Series	
Decode	Video Decode Type	Smart H.264+/H.264			
	Decode Capability	Max 4-ch 1080P 30fps or 8-ch 720P 30fs or 8-ch D1 30fps			
Video	Video Input	4/8-ch network compression video input	4/8-ch network compression video input		
	Video Output	1-channel VGA analog video output			
	HDMI	1-ch HDMI output. Version number is 1.4			
	Window Split	1/4/8/9-window	1/4/8/9-window		
Audio	Audio Input	1-ch bidirectional talk input			
	Audio Output	1-ch bidirectional talk output			
	Audio Compression Standard	G.711a			
Alarm	Alarm Input	N/A			
	Alarm Output	N/A			
Function	Storage	1 built-in SATA port			
	Multiple-Channel Playback	Max 4-channel 1080P or 8-channel 720P or 8-channel D1 playback			
Port and Indicator	RS232 Port	N/A			
	RS485 Port	N/A			
	USB Port	2 peripheral USB2.0 ports.			
	Network Connection	1 RJ45 10/100Mbps self-adaptive Ethernet port.			
	PoE Port	N/A	4	8	
	Power Port	1 power socket. Power adapter power supplying mode. DC 12V power.	1 power socket. Power adapter power supplying mode. DC 48V power.	1 power socket. Power adapter power supplying mode. DC 48V power.	
	Power Button	N/A			

Model		NVR1AHS Series	NVR1AHS-4P Series	NVR1AHS-8P Series
	Power On-off Button	N/A		
	IR Receiver Window	N/A		
	Clock	Built-in clock.		
	Indicator Light	One power status indicator light. One network status indicator light. One HDD status indicator light.		
General	Power Consumption	<10W (No HDD)		
	Working Temperature	- 10°C ~ + 55°C		
	Working Humidity	10%~90%		
	Air pressure	86kPa~106kPa		
	Dimension(W×D×H)	260mm×220mm×44mm		
	Weight	0.7kg~0.8kg (No HDD)		
	Installation Mode	Desk installation		

1.3.3 NVR2A16 Series

Model		NVR2A16 Series
System	System Resources	16-ch series product support 16 HD connection respectively. Total bandwidth supports 80Mbps.
	OS	Embedded Linux real-time operation system
	Operation Interface	WEB/Local GUI
Decode	Video Decode Type	Smart H.264+/H.264
	Decode Capability	Max 4-ch 1080P 30fps or 8-ch 720P 30fs or 8-ch D1 30fps
Video	Video Input	16-ch network compression video input
	Video Output	1-channel VGA analog video output
	HDMI	1-ch HDMI output. Version number is 1.4
	Window Split	1/4/8/9/16-window
Audio	Audio Input	1-ch bidirectional talk input

Model		NVR2A16 Series
	Audio Output	1-ch bidirectional talk output
	Audio Compression Standard	G.711a
Alarm	Alarm Input	N/A
	Alarm Output	N/A
Function	Storage	2 built-in SATA ports
	Multiple-Channel Playback	Max 4-channel 1080P or 8-channel 720P or 8-channel D1 playback
Port and Indicator	RS232 Port	N/A
	RS485 Port	N/A
	USB Port	2 peripheral USB2.0 ports.
	Network Connection	1 RJ45 10/100Mbps self-adaptive Ethernet port.
	PoE Port	N/A
	Power Port	1 power socket. Power adapter power supplying mode. DC 12V power.
	Power Button	N/A
	Power On-off Button	N/A
	IR Receiver Window	N/A
	Clock	Built-in clock.
Indicator Light	One power status indicator light. One network status indicator light. One HDD status indicator light.	
General	Power Consumption	<10W (No HDD)
	Working Temperature	- 10°C ~ + 55°C
	Working Humidity	10%~90%
	Air pressure	86kPa~106kPa
	Dimension(W×D×H)	375mm×287mm×52mm
	Weight	1.5kg~2.5kg (No HDD)

Model		NVR2A16 Series
	Installation Mode	Desk installation

1.3.4 NVR1B04/L, NVR1B08/L, NVR1B04-4P/L Series

Model		NVR1B04/L Series	NVR1B08/L Series	NVR1B04-4P/L Series
System	System Resources	4/8-ch series product support 4/8 HD connection respectively. Total bandwidth supports 48Mbps.		
	OS	Embedded Linux real-time operation system		
	Operation Interface	WEB/Local GUI		
Decode	Video Decode Type	H.265/H.264		
	Decode Capability	Max 2-ch 1080P 30fps or 4-ch 720P 30fps or 8-ch D1 30fps		
Video	Video Input	4/8-ch network compression video input		
	Video Output	1-channel VGA analog video output		
		1-ch HDMI output. Version number is 1.4		
Window Split	1/4-window	1/4/8/9-window	1/4-window	
Audio	Audio Input	N/A		
	Audio Output	N/A		
	Audio Compression Standard	N/A		

Model		NVR1B04/L Series	NVR1B08/L Series	NVR1B04-4P/L Series
Alarm	Alarm Input	N/A		
	Alarm Output	N/A		
Function	Storage	1 built-in SATA port		
	Multiple-Channel Playback	Max 4-channel playback		
Port and Indicator	RS232 Port	N/A		
	RS485 Port	N/A		
	USB Port	2 peripheral USB2.0 ports.		
	Network Connection	1 RJ45 10/100Mbps self-adaptive Ethernet port.		
	PoE	N/A	N/A	4 Ports
	Power Port	1 power socket. Power adapter power supplying mode. DC 12V power.		1 power socket. Power adapter power supplying mode. DC 48V power.
	Power Button	N/A		
	Power On-off Button	N/A		
	IR Receiver Window	N/A		
	Clock	Built-in clock.		
Indicator Light	One power status indicator light. One network status indicator light. One HDD status indicator light.			

Model		NVR1B04/L Series	NVR1B08/L Series	NVR1B04-4P/L Series
General	Power Consumption	<10W (No HDD)		
	Working Temperature	- 10°C ~ + 55°C		
	Working Humidity	10%~90%		
	Air pressure	86kPa~106kPa		
	Dimension	204.6mmx204.6mmx45.2mm		
	Weight	0.4kg~0.65kg (No HDD)		
	Installation Mode	Desk installation		

1.3.5 NVR1B04HS/L, NVR1B08HS/L, NVR1B04HS-4P/L Series

Model		NVR1B04HS/L Series	NVR1B08HS/L Series	NVR1B04HS-4P/L Series
System	System Resources	4/8-ch series product support 4/8 HD connection respectively. Total bandwidth supports 48Mbps.		
	OS	Embedded Linux real-time operation system		
	Operation Interface	WEB/Local GUI		
Decode	Video Decode Type	H.265/H.264		
	Decode Capability	Max 2-ch 1080P 30fps or 4-ch 720P 30fs or 8-ch D1 30fps		
Video	Video Input	4/8-ch network compression video input		
	Vieo Output	1-channel VGA analog video output		
		1-ch HDMI output. Version number is 1.4		
Window Split	1/4-window	1/4/8/9-window	1/4-window	
Audio	Audio Input	N/A		
	Audio Output	N/A		
	Audio	N/A		

Model		NVR1B04HS/L Series	NVR1B08HS/L Series	NVR1B04HS-4P/L Series
	Compression Standard			
Alarm	Alarm Input	N/A		
	Alarm Output	N/A		
Function	Storage	1 built-in SATA port		
	Multiple-Channel Playback	Max 4-channel playback		
Port and Indicator	RS232 Port	N/A		
	RS485 Port	N/A		
	USB Port	2 peripheral USB2.0 ports.		
	Network Connection	1 RJ45 10/100Mbps self-adaptive Ethernet port.		
	PoE Port	N/A	N/A	4 ports
	Power Port	1 power socket. Power adapter power supplying mode. DC 12V power.		1 power socket. Power adapter power supplying mode. DC 48V power.
	Power Button	N/A		
	Power On-off Button	N/A		
	IR Receiver Window	N/A		
	Clock	Built-in clock.		
	Indicator Light	One power status indicator light. One network status indicator light. One HDD status indicator light.		
General	Power Consumption	<10W (No HDD)		
	Working Temperature	- 10°C ~ + 55°C		
	Working Humidity	10%~90%		
	Air pressure	86kPa~106kPa		
	Dimension(W×D×H)	260mm×229.3mm×47.6mm		

Model		NVR1B04HS/L Series	NVR1B08HS/L Series	NVR1B04HS-4P/L Series
	Weight	0.9kg~1kg (No HDD)		
	Installation Mode	Desk installation		

1.3.6 NVR1B04, NVR1B08, NVR1B04-4P Series

Model		NVR1B04 Series	NVR1B08 Series	NVR1B04-4P Series
System	System Resources	4/8-ch series product support 4/8 HD connection respectively. Total bandwidth supports 80Mbps.		
	OS	Embedded Linux real-time operation system		
	Operation Interface	WEB/Local GUI		
Decode	Video Decode Type	H.265/H.264		
	Decode Capability	Max 1-ch 4K 30fps or 4-ch 1080P 30fps or 8-ch 720P 30fs		
Video	Video Input	4/8-ch network compression video input		
	Video Output	1-channel VGA analog video output		
		1-ch HDMI output. Version number is 1.4		
Window Split	1/4/8/9-window			
Audio	Audio Input	1-ch bidirectional talk input		
	Audio Output	1-ch bidirectional talk input		
	Audio Compression Standard	PCM、G.711a、G711u		
Alarm	Alarm Input	N/A		
	Alarm Output	N/A		
Function	Storage	1 built-in SATA port		
	Multiple-Channel Playback	Max 4-channel playback		
Port and Indicator	RS232 Port	N/A		
	RS485 Port	N/A		
	USB Port	2 peripheral USB2.0 ports.		

Model		NVR1B04 Series	NVR1B08 Series	NVR1B04-4P Series
	Network Connection	1 RJ45 10/100Mbps self-adaptive Ethernet port.		
	PoE Port	N/A	N/A	4 ports
	Power Port	1 power socket. Power adapter power supplying mode. DC 12V power.		1 power socket. Power adapter power supplying mode. DC 48V power.
	Power Button	N/A		
	Power On-off Button	N/A		
	IR Receiver Window	N/A		
	Clock	Built-in clock.		
	Indicator Light	One power status indicator light. One network status indicator light. One HDD status indicator light.		
General	Power Consumption	<10W (No HDD)		
	Working Temperature	- 10°C ~ + 55°C		
	Working Humidity	10%~90%		
	Air pressure	86kPa~106kPa		
	Dimension(W×D×H)	204.6mm× 206.6mm×45.2mm		
	Weight	0.9kg~1kg (No HDD)		
	Installation Mode	Desk installation		

1.3.7 NVR1B04HS, NVR1B08HS, NVR1B04HS-4P, NVR1B08HS-8P Series

Model		NVR1B04HS Series	NVR1B08HS Series	NVR1B04HS-4P Series	NVR1B08HS-8P Series
System	System Resources	4/8-ch series product support 4/8 HD connection respectively. Total bandwidth supports 80Mbps.			
	OS	Embedded Linux real-time operation system			
	Operation Interface	WEB/Local GUI			

Model		NVR1B04HS Series	NVR1B08HS Series	NVR1B04HS-4P Series	NVR1B08HS-8P Series
Decode	Video Decode Type	H.265/H.264			
	Decode Capability	Max 1-ch 4K 30fps or 4-ch 1080P 30fps or 8-ch 720P 30fs			
Video	Video Input	4/8-ch network compression video input			
	Video Output	1-channel VGA analog video output			
		1-ch HDMI output. Version number is 1.4			
Window Split	1/4-window	1/4/8/9-window	1/4-window	1/4/8/9-window	
Audio	Audio Input	N/A			
	Audio Output	N/A			
	Audio Compression Standard	PCM、G.711a、G711u			
Alarm	Alarm Input	N/A			
	Alarm Output	N/A			
Function	Storage	1 built-in SATA port			
	Multiple-Channel Playback	Max 4-channel playback			
Port and Indicator	RS232 Port	N/A			
	RS485 Port	N/A			
	USB Port	2 peripheral USB2.0 ports.			
	Network Connection	1 RJ45 10/100Mbps self-adaptive Ethernet port.			1 RJ45 10/100/1000Mbps self-adaptive Ethernet port.
	PoE Port	N/A	N/A	4 ports	8 ports
	Power Port	1 power socket. Power adapter power supplying mode. DC 12V power.		1 power socket. Power adapter power supplying mode. DC 48V power.	
	Power Button	N/A			
	Power On-off Button	N/A			

Model		NVR1B04HS Series	NVR1B08HS Series	NVR1B04HS-4P Series	NVR1B08HS-8P Series
	IR Receiver Window	N/A			
	Clock	Built-in clock.			
	Indicator Light	One power status indicator light. One network status indicator light. One HDD status indicator light.			
General	Power Consumption	<10W (No HDD)			
	Working Temperature	- 10°C ~ + 55°C			
	Working Humidity	10%~90%			
	Air pressure	86kPa~106kPa			
	Dimension(W×D×H)	260mm×229.3mm×47.6mm			
	Weight	0.9kg~1kg (No HDD)			
	Installation Mode	Desk installation			

1.3.8 NVR2B16 Series

Model		NVR2B16 Series
System	System Resources	16-ch series product support 16 HD connection respectively. Total bandwidth supports 80Mbps.
	OS	Embedded Linux real-time operation system
	Operation Interface	WEB/Local GUI
Decode	Video Decode Type	Smart H.265/H.264
	Decode Capability	Max 4-ch 1080P 30fps or 8-ch 720P 30fs
Video	Video Input	16-ch network compression video input
	Video Output	1-channel VGA analog video output
		1-ch HDMI output. Version number is 1.4
Window Split	1/4/8/9/16-window	
Audio	Audio Input	1-ch bidirectional talk input

Model		NVR2B16 Series
	Audio Output	1-ch bidirectional talk output
	Audio Compression Standard	PCM、G.711a、G711u
Alarm	Alarm Input	N/A
	Alarm Output	N/A
Function	Storage	2 built-in SATA ports
	Multiple-Channel Playback	Max 4-channel playback
Port and Indicator	RS232 Port	N/A
	RS485 Port	N/A
	USB Port	2 peripheral USB2.0 ports.
	Network Connection	1 RJ45 10/100Mbps self-adaptive Ethernet port.
	PoE Port	N/A
	Power Port	1 power socket. Power adapter power supplying mode. DC 12V power.
	Power Button	N/A
	Power On-off Button	N/A
	IR Receiver Window	N/A
	Clock	Built-in clock.
Indicator Light	One power status indicator light. One network status indicator light. One HDD status indicator light.	
General	Power Consumption	<10W (No HDD)
	Working Temperature	- 10℃ ~ + 55℃
	Working Humidity	10%~90%
	Air pressure	86kPa~106kPa
	Dimension(W×D×H)	375mm×282.6mm×53mm
	Weight	1.5kg~2.5kg (No HDD)

Model		NVR2B16 Series
	Installation Mode	Desk installation

1.3.9 NVR1BHC/E, NVR1BHC-4P/E Series

Model		NVR1BHC/E	NVR1BHC-4P/E
System	Host Processor	Industrial grade embedded microcontroller	
	OS	Embedded Linux operation system	
	System Resources	4-channel/8-channel NVR supports 4-channel/8-channel HD input respectively	
	Operation Interface	Web, local GUI	
Audio	Audi Input	N/A	
	Audio Output	N/A	
	Audio Compression Standard	PCM, G711a, G711u	
Video	Video Input	4-channel and 8-channel network compression video input	
	Video Output	1-channel VGA analog video output; 1-channel HDMI video output. Same source output.	
	Video Compression Standard	Not support.	
	Window Split	1/4/8/9-window	
Alarm	Alarm Input	N/A	
	Alarm Output	N/A	
Decode	Decoding Type	H.264; H265; MPEG4; smart264; smart265	
	Decoding Capability	1-channel 6M, 1-channel 5M, 2-channel 4M, 4-channel 1080P, 8-channel 720P	
Function	Record Mode	Manual record, motion detect record, schedule record and alarm record. Record priority: Manual record > alarm record > motion detect record > schedule record.	
	Multi-Channel Playback	Max 4-channel 1080P playback at the same time	
	Motion Detect	Each video supports PAL 396(22*18) detection zones, support multiple sensivity levels from level 1 to level 6	
	Tampering	Each channel supports 4 tampering zones	
	Record Storage	Local HDD, network, etc.	
	Backup Mode	External USB storage device	
Ports	Network Protocol	IPv4, IPv6, HTTP, NTP, DNS, ONVIF	
	SATA Port	One	

Model		NVR1BHC/E	NVR1BHC-4P/E
	eSATA Port	N/A	
	RS232 Port	N/A	
	RS485 Port	N/A	
	USB Port	Two USB 2.0	
	HDMI Port	One	
	VGA Port	One	
	Network Port	One RJ45 10/100Mbps self-adaptive Ethernet port	
	Power on-off Button	N/A	
	Power Button	N/A	
	IR Receiver Window	N/A	
	Clock	One built-in real-time clock	
	Indicator	N/A	
	General	Power input	DC12V 1.5A
Power consumption		2.57W (no HDD)	3.61W (no HDD)
Working temp		-10°C to +45°C	
Working humidity		10% to 90%	
Atmospheric pressure		86kpa to 106kpa	
Dimension		192 mm * 197 mm * 42 mm	
Weight		1.15kg	1.46kg
Installation mode		Desktop	

1.3.10 NVR1BHS-8P/E Series

Model		NVR1BHS-8P/E
System	Host Processor	Industrial grade embedded microcontroller
	OS	Embedded Linux operation system
	System Resources	8-channel NVR supports 8-channel HD input respectively
	Operation Interface	Web, local GUI
Audio	Audi Input	N/A
	Audio Output	N/A
	Audio Compression Standard	PCM, G711a, G711u
Video	Video Input	8-channel network compression video input
	Video Output	1-channel VGA analog video output; 1-channel HDMI video output. Same source output.

Model		NVR1BHS-8P/E
	Video Compression Standard	Not support.
	Window Split	1/4/8/9-window
Alarm	Alarm Input	N/A
	Alarm Output	N/A
Decode	Decoding Type	H.264; H265; MPEG4; smart264; smart265
	Decoding Capability	1-channel 6M, 1-channel 5M, 2-channel 4M, 4-channel 1080P, 8-channel 720P
Function	Record Mode	Manual record, motion detect record, schedule record and alarm record. Record priority: Manual record > alarm record > motion detect record > schedule record.
	Multi-Channel Playback	Max 4-channel 1080P playback at the same time
	Motion Detect	Each video supports PAL 396(22*18) detection zones, support multiple sensivity levels from level 1 to level 6
	Tampering	Each channel supports 4 tampering zones
	Record Storage	Local HDD, network, etc.
	Backup Mode	External USB storage device
Ports	Network Protocol	IPv4, IPv6, HTTP, NTP, DNS, ONVIF
	SATA Port	One
	eSATA Port	N/A
	RS232 Port	N/A
	RS485 Port	N/A
	USB Port	Two USB 2.0
	HDMI Port	One
	VGA Port	One
	Network Port	One RJ45 10/100Mbps self-adaptive Ethernet port
	Power on-off Button	N/A
	Power Button	N/A
	IR Receiver Window	N/A
	Clock	One built-in real-time clock
Indicator	N/A	
General	Power input	DC48V/2A
	Power consumption	4.29W (no HDD)
	Working temp	-10°C to +45°C
	Working humidity	10% to 90%

Model		NVR1BHS-8P/E
	Atmospheric pressure	86kpa to 106kpa
	Dimension	221 mm * 260 mm * 48 mm
	Weight	2kg
	Installation mode	Desktop

2 Front Panel and Rear Panel



NOTE

The following front panel and rear panel figures are for reference only. The actual product shall prevail.

2.1 Front Panel

2.1.1 NVR1A-4P, NVR1A-8P, NVR1B04 (/L), NVR1B08 (/L), NVR1B04-4P (/L) Series

The front panel is shown as in Figure 2-1.

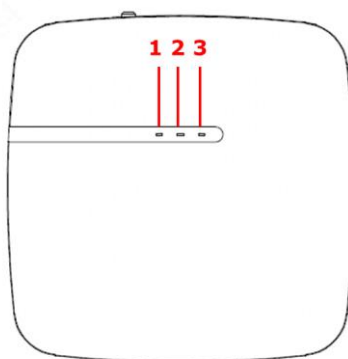

Figure 2-1

Please refer to the following sheet for detailed information.

SN	Name	Function
1	HDD status indicator light	The red light becomes on when HDD is abnormal.
2	Power indicator light	The red light becomes on when the power connection is OK.
3	Network status indicator light	The red light becomes on when the network connection is abnormal.

2.1.2 NVR1AHS, NVR1AHS-4P, NVR1AHS-8P, NVR2A16, NVR1B04HS (/L), NVR1B08HS (/L), NVR1B04HS-4P (/L), NVR1B08HS-8P, NVR2B16 Series

The front panel is shown as in Figure 2-2.

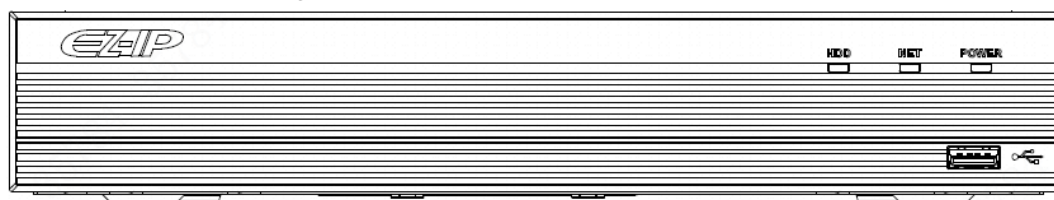



Figure 2-2

Please refer to the following sheet for front panel button information.

Icon	Name	Function
HDD	HDD status indicator light	The blue light is on when the HDD is malfunction.

Icon	Name	Function
NET	Network status indicator light	The blue light is on when the network connection is abnormal.
POWER	Power status indicator light	The blue light is on when the power connection is OK.
	USB port	Connect to peripheral USB storage device, mouse and etc.

2.1.3 NVR1BHC/E, NVR1BHC-4P/E, NVR1BHS-8P/E Series

The NVR1BHC/E, NVR1BHC-4P/E series front panel is shown as in Figure 2-3.

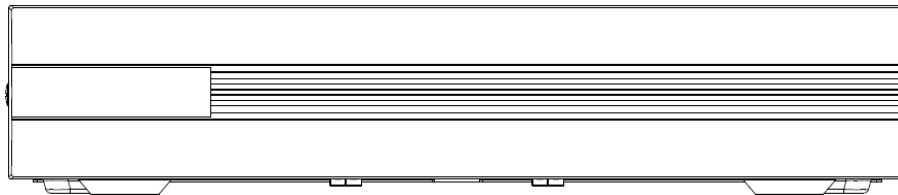

Figure 2-3

The NVR1BHS-8P/E series front panel is shown as in Figure 2-4.

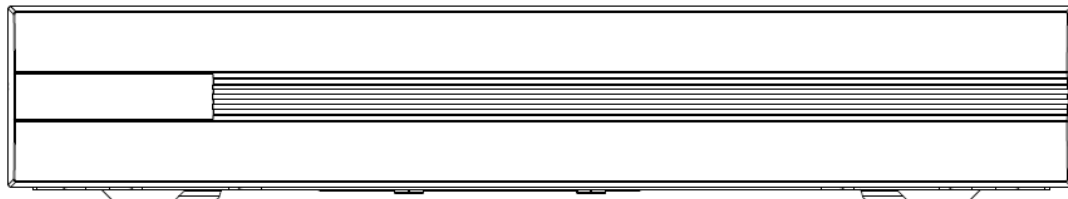

Figure 2-4

2.2 Rear Panel

2.2.1 NVR1B04/L, NVR1B08/L, NVR1B04-4P/L Series

The NVR1B04/L, NVR1B08/L series rear panel is shown as in Figure 2-5.

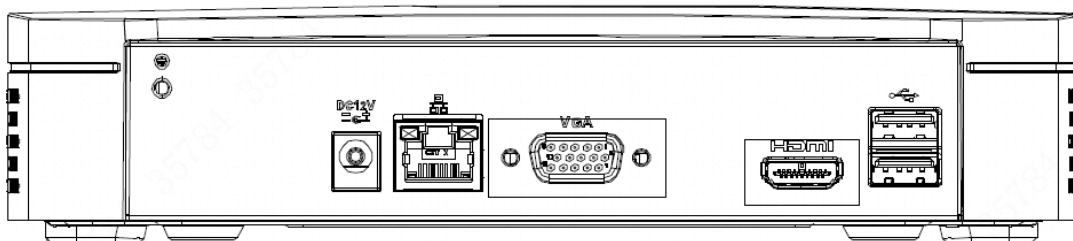

Figure 2-5

The NVR1B04-4P/L series rear panel is shown as in Figure 2-6.

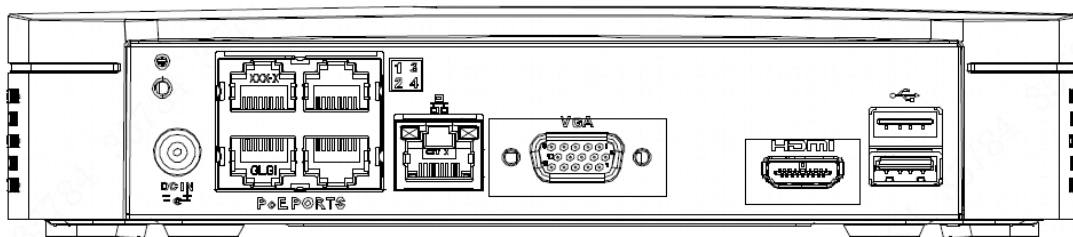

Figure 2-6

2.2.2 NVR1A-4P, NVR1A-8P, NVR1B04, NVR1B08, NVR1B04-4P Series

The NVR1A-4P series rear panel is shown as in Figure 2-7.

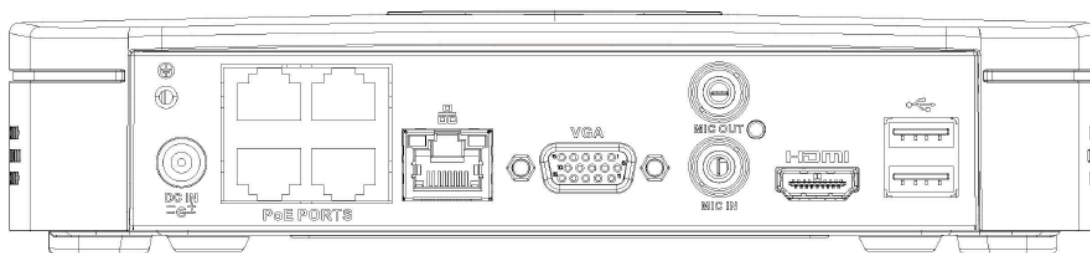

Figure 2-7

The NVR1A-8P series rear panel is shown as in Figure 2-8.

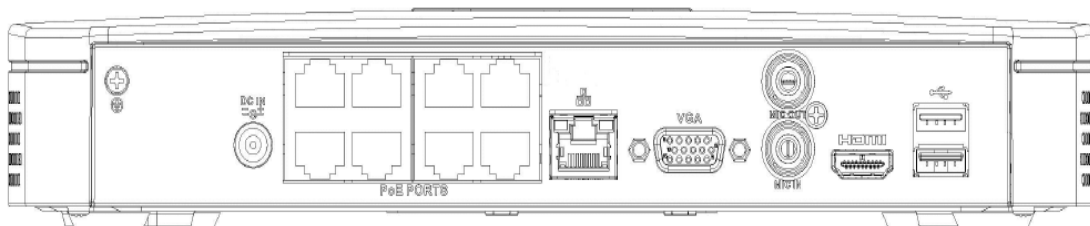

Figure 2-8

The NVR1B04/1B08 series rear panel is shown as in Figure 2-9.

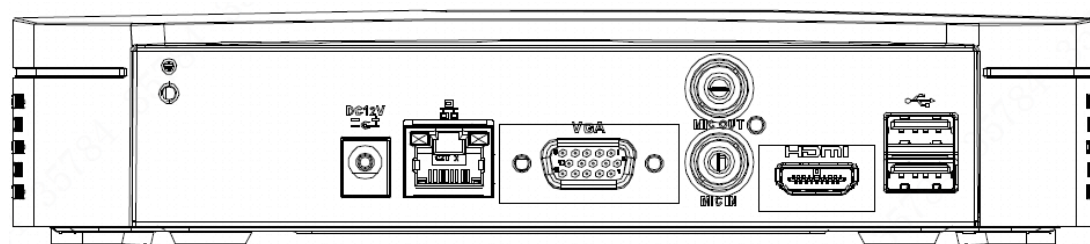

Figure 2-9

The NVR1B04-4P series rear panel is shown as in Figure 2-10.

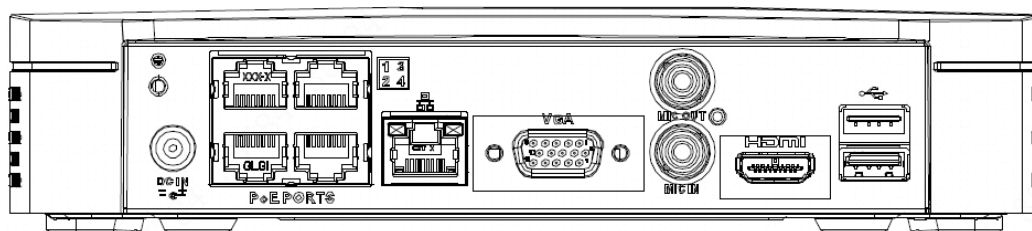





Figure 2-10

Please refer to the following sheet for detailed information.

Port Name	Connection	Function
DC 12V	Power input port	Power socket <ul style="list-style-type: none"> For NVR1B04-4P, input DC 48V/1.25A.
	Network port	10M/100Mbps self-adaptive Ethernet port. Connect to the network cable.

Port Name	Connection	Function
	USB port	USB port. Connect to mouse, USB storage device and etc.
HDMI	High Definition Media Interface	High definition audio and video signal output port. It transmits uncompressed high definition video and multiple-channel data to the HDMI port of the display device. HDMI version is 1.4.
VGA	VGA video output port	VGA video output port. Output analog video signal. It can connect to the monitor to view analog video.
MIC IN	Audio input port	Bidirectional talk input port. It is to receive the analog audio signal output from the devices such as microphone, pickup.
MIC OUT	Audio output port	Audio output port. It is to output the analog audio signal to the devices such as the sound box. <ul style="list-style-type: none"> ● Bidirectional talk output. ● Audio output on 1-window video monitor. ● Audio output on 1-window video playback.
	GND	Ground end
PoE PORTS	PoE port	Built-in switch. Support PoE function. For PoE series product, you can use this port to provide power to the network camera.

2.2.3 NVR1B04HS/L, NVR1B08HS/L, NVR1B04HS-4P/L Series

The NVR1B04HS/L, NVR1B08HS/L series rear panel is shown as below. See Figure 2-11.

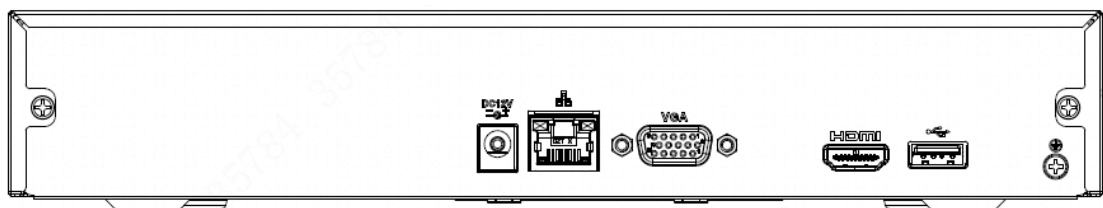

Figure 2-11

The NVR1B04HS-4P/L series rear panel is shown as below. See Figure 2-12.

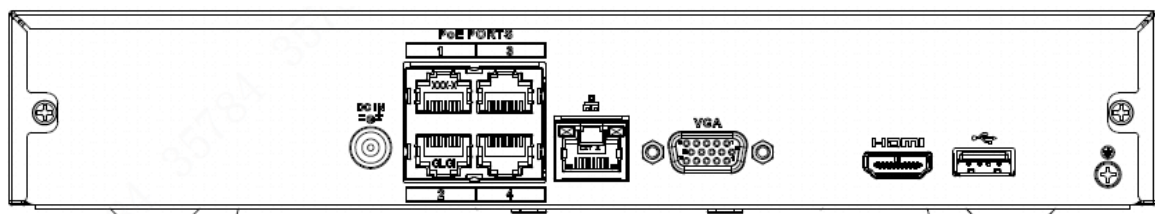

Figure 2-12

2.2.4 NVR1AHS, NVR1AHS-4P, NVR1AHS-8P, NVR1B04HS, NVR1B08HS, NVR1B04HS-4P, NVR1B08HS-8P Series

The NVR1AHS series rear panel is shown as below. See Figure 2-13.

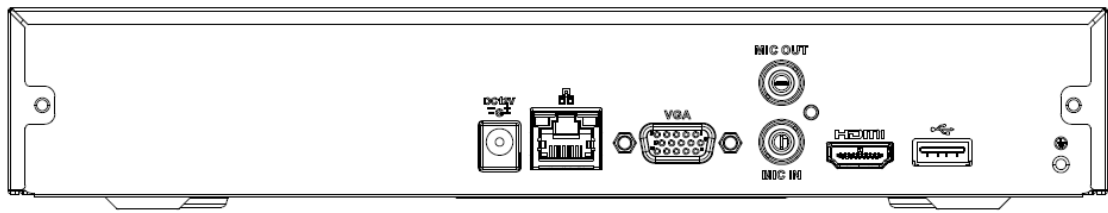

Figure 2-13

The NVR1AHS-4P series rear panel is shown as below. See Figure 2-14.

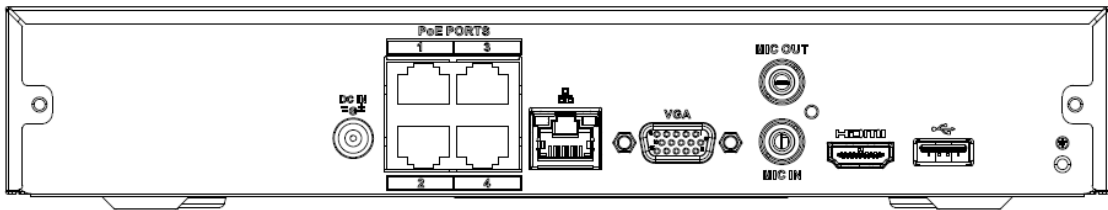

Figure 2-14

The NVR1AHS-8P series rear panel is shown as below. See Figure 2-15.

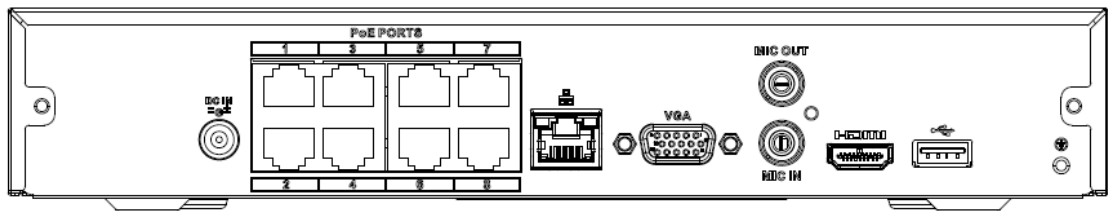

Figure 2-15

The NVR1B04HS, NVR1B08HS series rear panel is shown as below. See Figure 2-16.

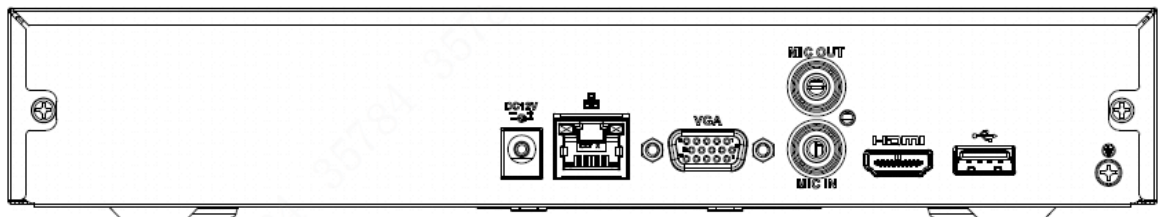

Figure 2-16

The NVR1B04HS-4P series rear panel is shown as below. See Figure 2-17.

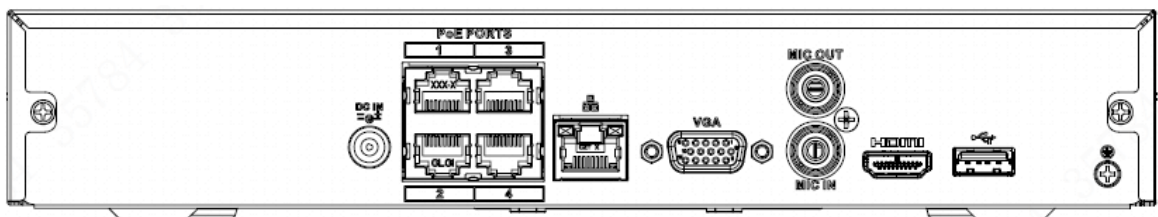

Figure 2-17

The NVR1B08HS-8P series rear panel is shown as below. See Figure 2-18.

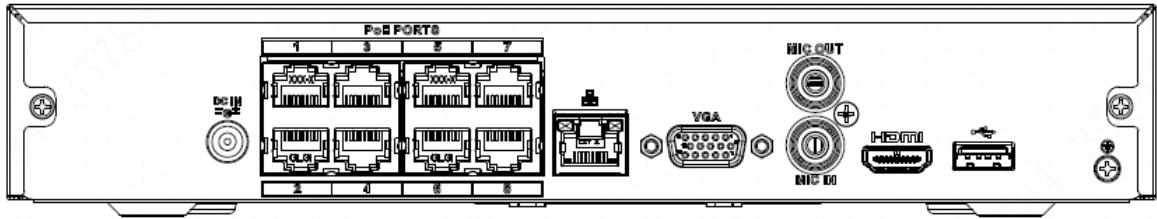





Figure 2-18

Please refer to the following sheet for detailed information.

Port Name	Connection	Function
DC 12V	Power input port	Power socket. <ul style="list-style-type: none"> For NVR1B04/08HS, input DC 12V/2A. For NVR1BHS-4P, input DC 48V/1.25A. For NVR1BHS-8P, input DC 48V/2A.
	Network port	10M/100Mbps self-adaptive Ethernet port. Connect to the network cable.
	USB port	USB port. Connect to mouse, USB storage device and etc.
HDMI	High Definition Media Interface	High definition audio and video signal output port. It transmits uncompressed high definition video and multiple-channel data to the HDMI port of the display device. HDMI version is 1.4.
VGA	VGA video output port	VGA video output port. Output analog video signal. It can connect to the monitor to view analog video.
MIC IN	Audio input port	Bidirectional talk input port. It is to receive the analog audio signal output from the devices such as microphone, pickup.
MIC OUT	Audio output port	Audio output port. It is to output the analog audio signal to the devices such as the sound box. <ul style="list-style-type: none"> Bidirectional talk output. Audio output on 1-window video monitor. Audio output on 1-window video playback.
	GND	Ground end
PoE PORTS	PoE port	Built-in switch. Support PoE function. For PoE series product, you can use this port to provide power to the network camera.

2.2.5 NVR2A16, NVR2B16 Series

The NVR2A16 series rear panel is shown as below. See Figure 2-19.

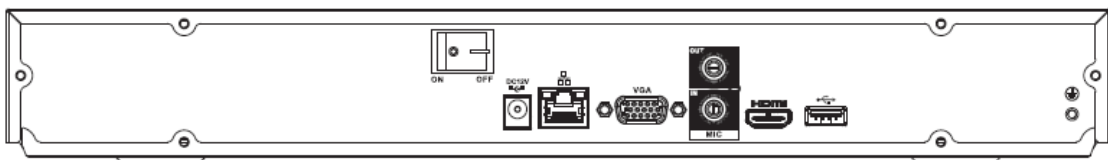

Figure 2-19

The NVR2B16 series rear panel is shown as below. See Figure 2-20.

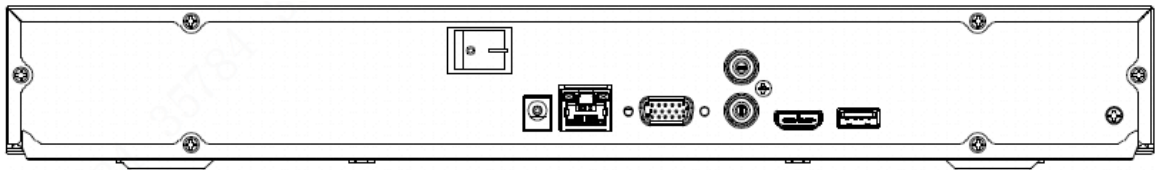





Figure 2-20

Please refer to the following sheet for detailed information.

Port Name	Connection	Function
DC 12V	Power input port	Power socket.
	Network port	10M/100Mbps self-adaptive Ethernet port. Connect to the network cable.
	USB port	USB port. Connect to mouse, USB storage device and etc.
HDMI	High Definition Media Interface	High definition audio and video signal output port. It transmits uncompressed high definition video and multiple-channel data to the HDMI port of the display device. HDMI version is 1.4.
VGA	VGA video output port	VGA video output port. Output analog video signal. It can connect to the monitor to view analog video.
MIC IN	Audio input port	Bidirectional talk input port. It is to receive the analog audio signal output from the devices such as microphone, pickup.
MIC OUT	Audio output port	Audio output port. It is to output the analog audio signal to the devices such as the sound box. <ul style="list-style-type: none"> ● Bidirectional talk output. ● Audio output on 1-window video monitor. ● Audio output on 1-window video playback.
	GND	Ground end

2.2.6 NVR1BHC/E, NVR1BHC-4P/E, NVR1BHS-8P/E Series

The NVR1BHC/E series rear panel is shown as below. See Figure 2-21.

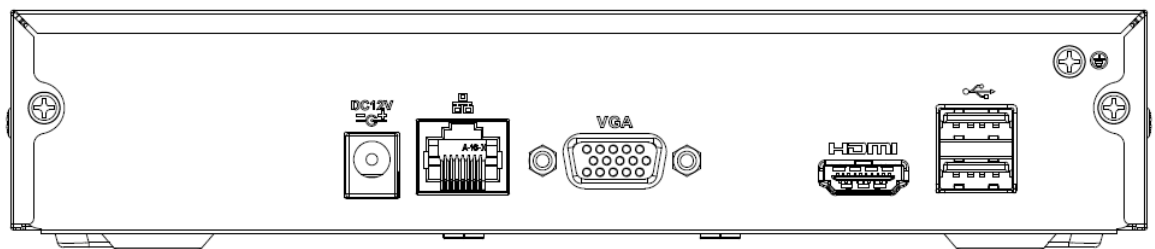

Figure 2-21

The NVR1BHC-4P/E series rear panel is shown as below. See Figure 2-22.

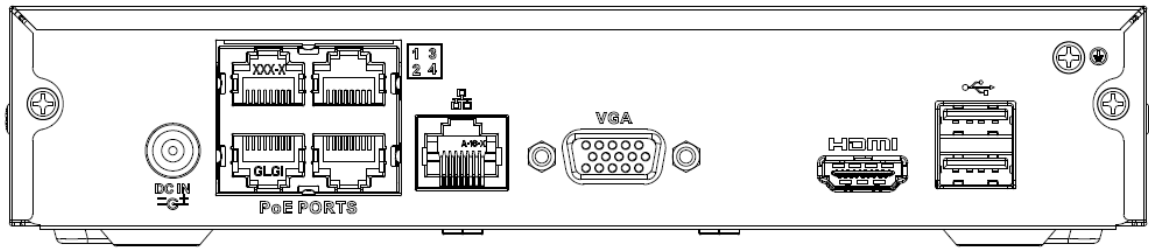

Figure 2-22

The NVR1BHS-8P/E series rear panel is shown as below. See Figure 2-23

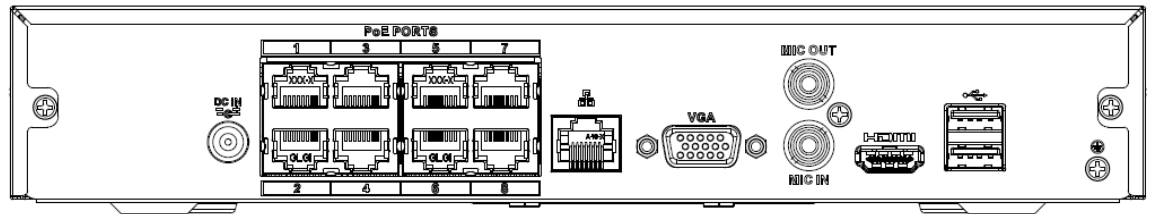

Figure 2-23

Please refer to the following sheet for detailed information.

Port Name	Connection	Function
DC 12V 	Power input port	Power socket.
PoE PORTS	PoE port	Built-in switch. Support PoE function. For PoE series product, you can use this port to provide power to the network camera.
	Network port	10M/100Mbps self-adaptive Ethernet port. Connect to the network cable.
VGA	VGA video output port	VGA video output port. Output analog video signal. It can connect to the monitor to view analog video.
MIC IN	Audio input port	Bidirectional talk input port. It is to receive the analog audio signal output from the devices such as microphone, pickup.
MIC OUT	Audio output port	Audio output port. It is to output the analog audio signal to the devices such as the sound box. <ul style="list-style-type: none"> ● Bidirectional talk output. ● Audio output on 1-window video monitor. ● Audio output on 1-window video playback.
HDMI	High Definition Media Interface	High definition audio and video signal output port. It transmits uncompressed high definition video and multiple-channel data to the HDMI port of the display device.
	USB port	USB port. Connect to mouse, USB storage device and etc.
	GND	Ground end

2.3 Bidirectional talk

2.3.1 Device-end to PC-end

Device Connection

Please connect the speaker or the pickup to the first audio input port in the device rear panel. Then connect the earphone or the sound box to the audio output port in the PC.

Login the Web and then enable the corresponding channel real-time monitor.

Please refer to the following interface to enable bidirectional talk. See Figure 2-24.

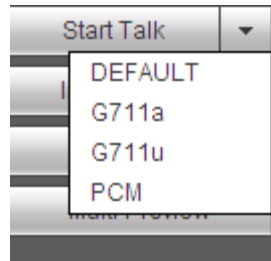

Figure 2-24

Listening Operation

At the device end, speak via the speaker or the pickup, and then you can get the audio from the earphone or sound box at the pc-end. See Figure 2-25.

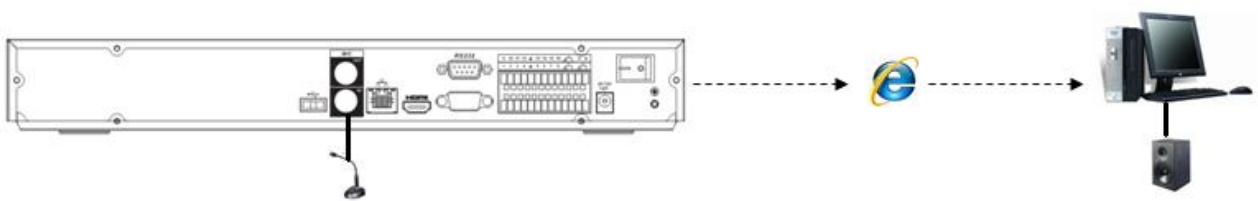

Figure 2-25

2.3.2 PC-end to the device-end

Device Connection

Connect the speaker or the pickup to the audio output port in the PC and then connect the earphone or the sound box to the first audio input port in the device rear panel.

Login the Web and then enable the corresponding channel real-time monitor.

Please refer to the above interface (Figure 2-24) to enable bidirectional talk.

Listening Operation

At the PC-end, speak via the speaker or the pickup, and then you can get the audio from the earphone or sound box at the device-end. See Figure 2-26.

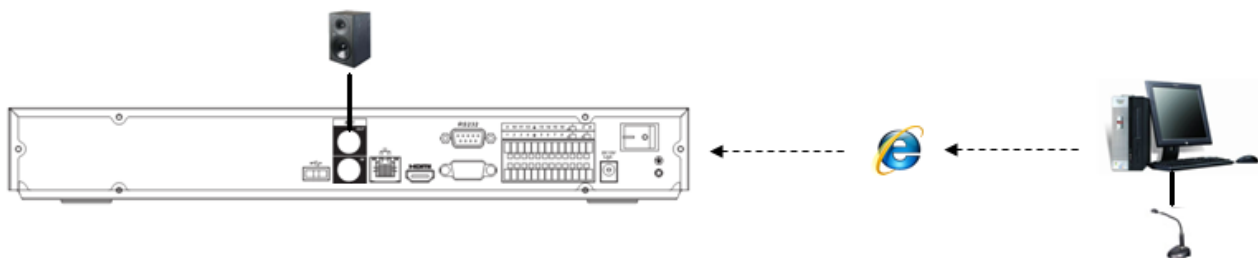
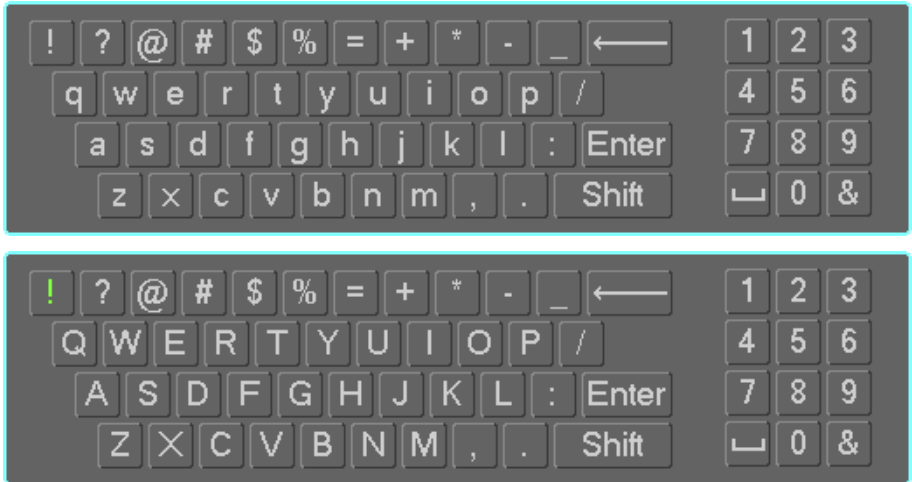

Figure 2-26

2.4 Mouse Operation

Please refer to the following sheet for mouse operation instruction.

Left click mouse	When you have selected one menu item, left click mouse to view menu content.
	Modify checkbox or motion detection status.
	Click combo box to pop up dropdown list
	In input box, you can select input methods. Left click the corresponding button on the panel you can input numeral/English character (small/capitalized). Here ← stands for backspace button. _ stands for space button. In English input mode: _stands for input a backspace icon and ← stands for deleting the previous character.
	
	In numeral input mode: _ stands for clear and ← stands for deleting the previous numeral.
Double left click mouse	Implement special control operation such as double click one item in the file list to playback the video.
	In multiple-window mode, double left click one channel to view in full-window. Double left click current video again to go back to previous multiple-window mode.
Right click mouse	In real-time monitor mode, pops up shortcut menu.
	Exit current menu without saving the modification.
Press middle button	In numeral input box: Increase or decrease numeral value.
	Switch the items in the check box.
	Page up or page down
Move mouse	Select current control or move control
Drag mouse	Select motion detection zone
	Select privacy mask zone.

3 Device Installation

Note: All the installation and operations here should conform to your local electric safety rules.

3.1 Device Installation Diagrams

Please refer to the following diagrams to install the NVR.

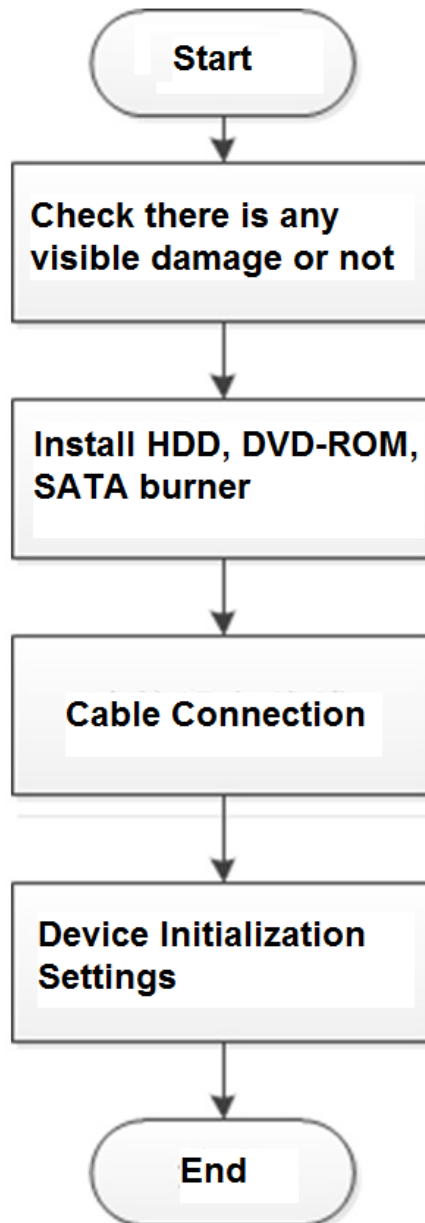

3.2 Check Unpacked NVR

When you receive the NVR from the forwarding agent, please check whether there is any visible damage. The protective materials used for the package of the NVR can protect most accidental clashes during transportation. Then you can open the box to check the accessories.

Please check the items in accordance with the list. Finally you can remove the protective film of the NVR.

3.3 About Front Panel and Rear Panel

The model number in the stick on the bottom of NVR is very important; please check according to your purchase order.

The label in the rear panel is very important too. Usually we need you to represent the serial number when we provide the service after sales.

3.4 HDD Installation

For the first time installation, make sure whether the HDD has been installed or not. We recommend to use HDD of enterprise level or surveillance level. It is not recommended to use PC HDD.



- Shut off the power before you replace the HDD.
- Use the dedicated SATA HDD for monitoring recommended by the HDD manufacturer.
- You can refer to the Appendix for HDD space information and recommended HDD brand.

3.4.1 NVR1A-4P, NVR1A-8P, NVR1B04 (/L), NVR1B08 (/L), NVR1B04-4P (/L) Series

Step1 Turn over the device and remove the four fixing screws on the baseboard of the device.

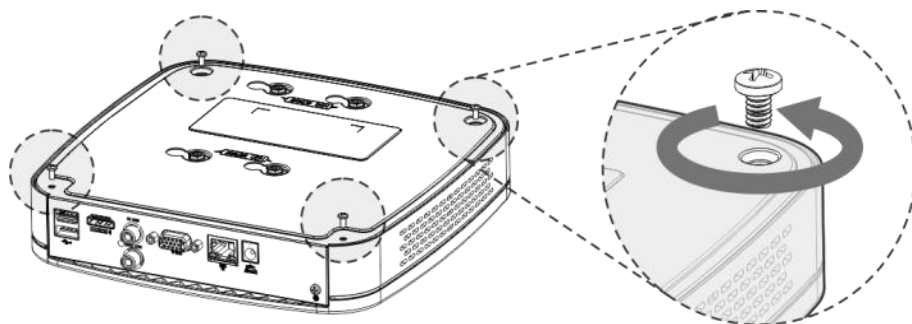

Figure 3-1

Step2 Remove the case cover along the direction shown in the following arrow.

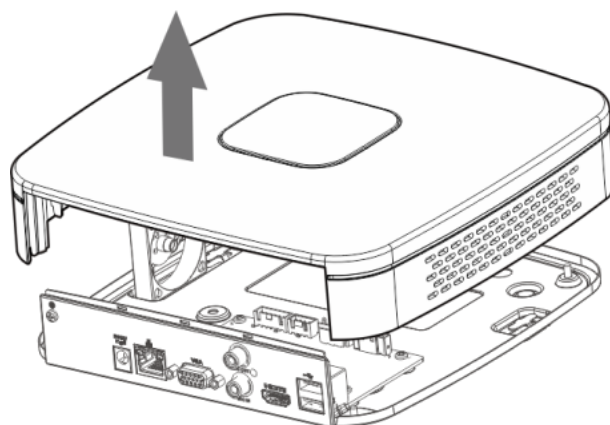

Figure 3-2

Step3 Match the four holes on the baseboard to place the HDD.

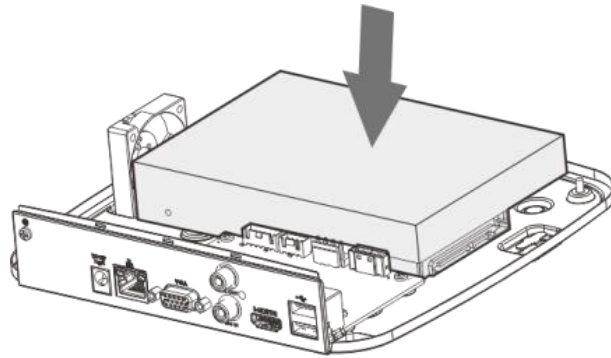

Figure 3-3

Step4 Turn the device upside down, match the screws with the holes on the HDD and then fasten them. The HDD is fixed to the baseboard.

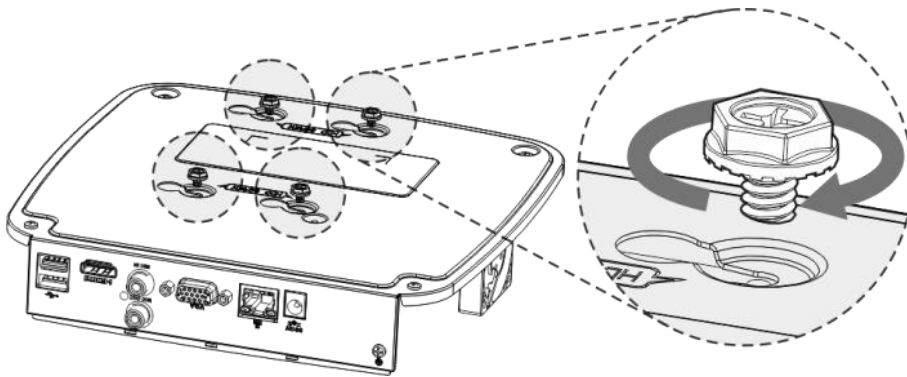

Figure 3-4

Step5 Connect the HDD data cable and power cable to the device.

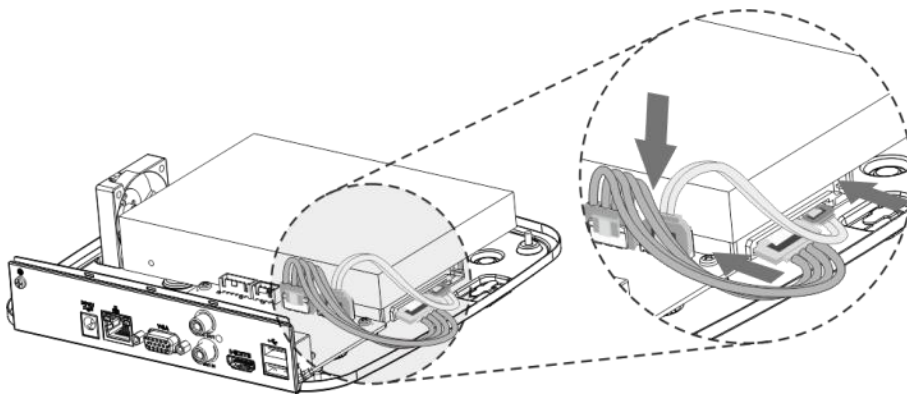

Figure 3-5

Step6 Put back the cover and fasten the four screws on the baseboard to complete the installation.



Figure 3-6

3.4.2 NVR1AHS, NVR1AHS-4P, NVR1AHS-8P, NVR1B04HS (/L), NVR1B08HS (/L), NVR1B04HS-4P (/L), NVR1B08HS-8P, NVR2A16, NVR2B16, NVR1BHC/E, NVR1BHC-4P/E, NVR1BHS-8P/E Series

Step1 Remove the fixing screws of the case cover (including the two screws on the rear panel and two screws on the left and right panels).

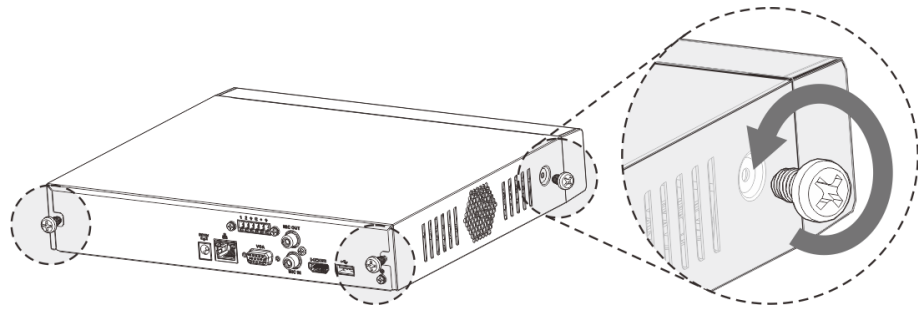

Figure 3-7

Step2 Remove the case cover along the direction shown in the following arrow .

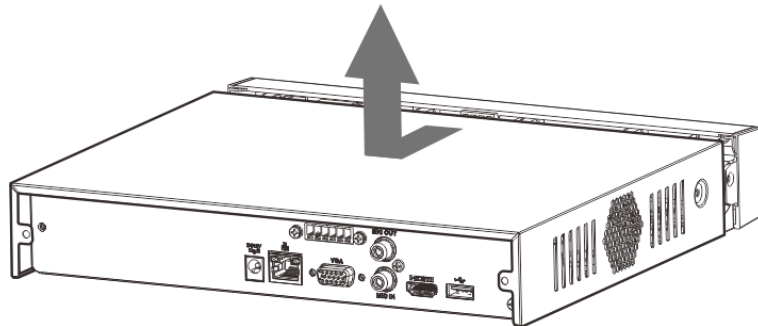

Figure 3-8

Step3 Match the four holes on the baseboard to place the HDD.

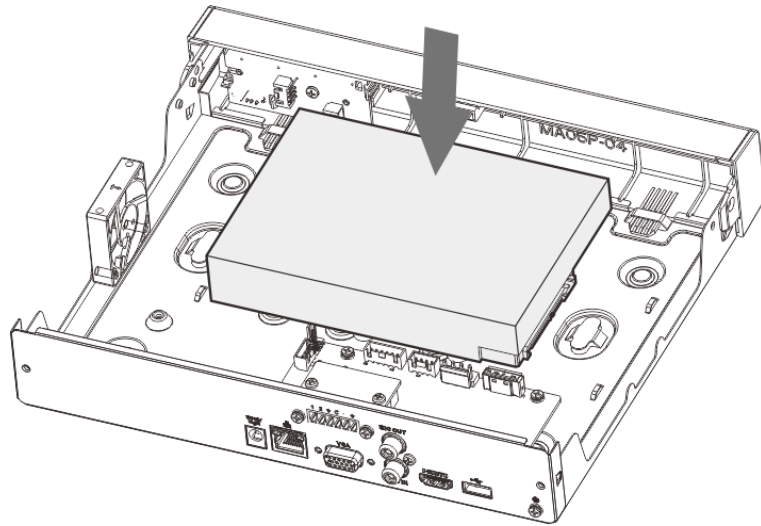

Figure 3-9

- Step4 Turn the device upside down, match the screws with the holes on the HDD and then fasten them. The HDD is fixed to the baseboard

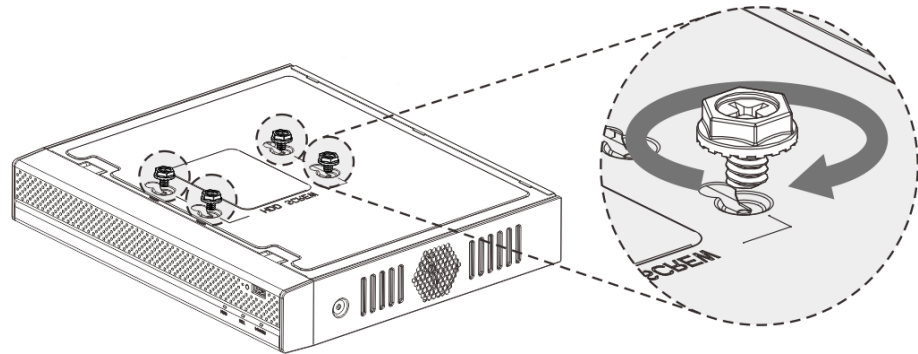

Figure 3-10

- Step5 Connect the HDD data cable and power cable to the device.

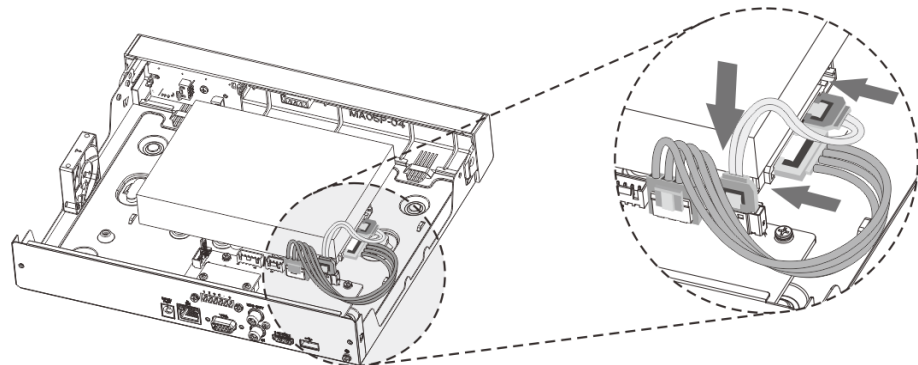

Figure 3-11

- Step6 Put back the cover and fasten the screws on the rear panel and side panels to complete the installation.

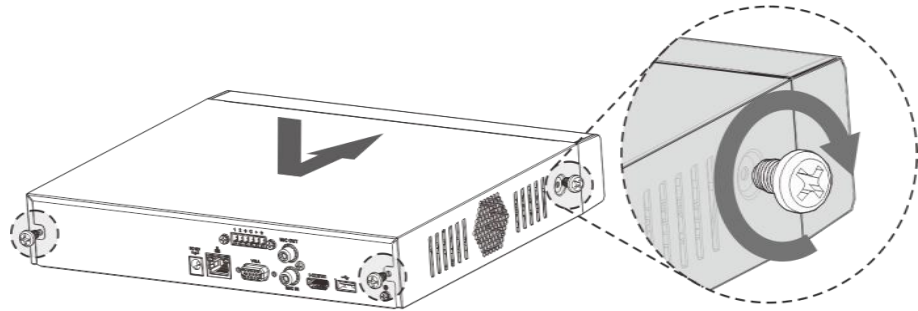

Figure 3-12

3.5 Connection Sample

3.5.1 NVR1A-4P, NVR1A-8P, NVR1B04 (/L), NVR1B08 (/L), NVR1B04-4P (/L) Series

Please refer to Figure 3-13 for connection sample.

The following figure for reference only.

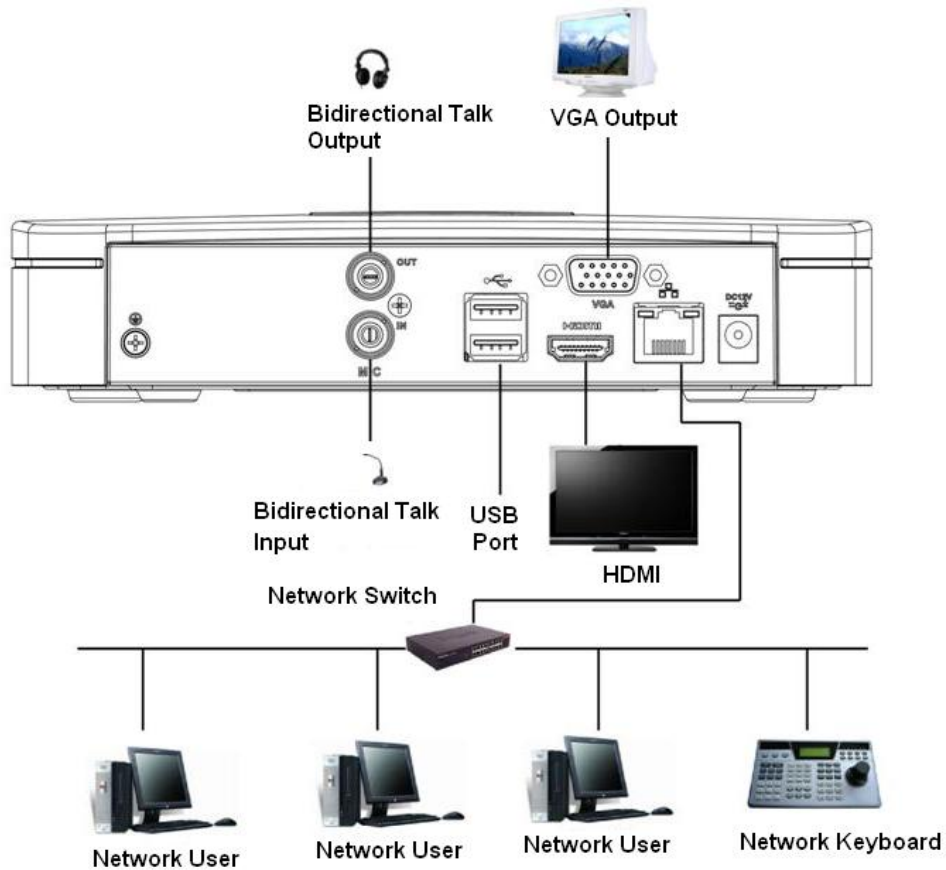

Figure 3-13

3.5.2 NVR1AHS, NVR1AHS-4P, NVR1AHS-8P, NVR1B04HS (/L), NVR1B08HS (/L), NVR1B04HS-4P (/L), NVR1B08HS-8P, NVR1BHC/E, NVR1BHC-4P/E, NVR1BHS-8P/E Series

Please refer to Figure 3-14 for connection sample.

The following figure for reference only.

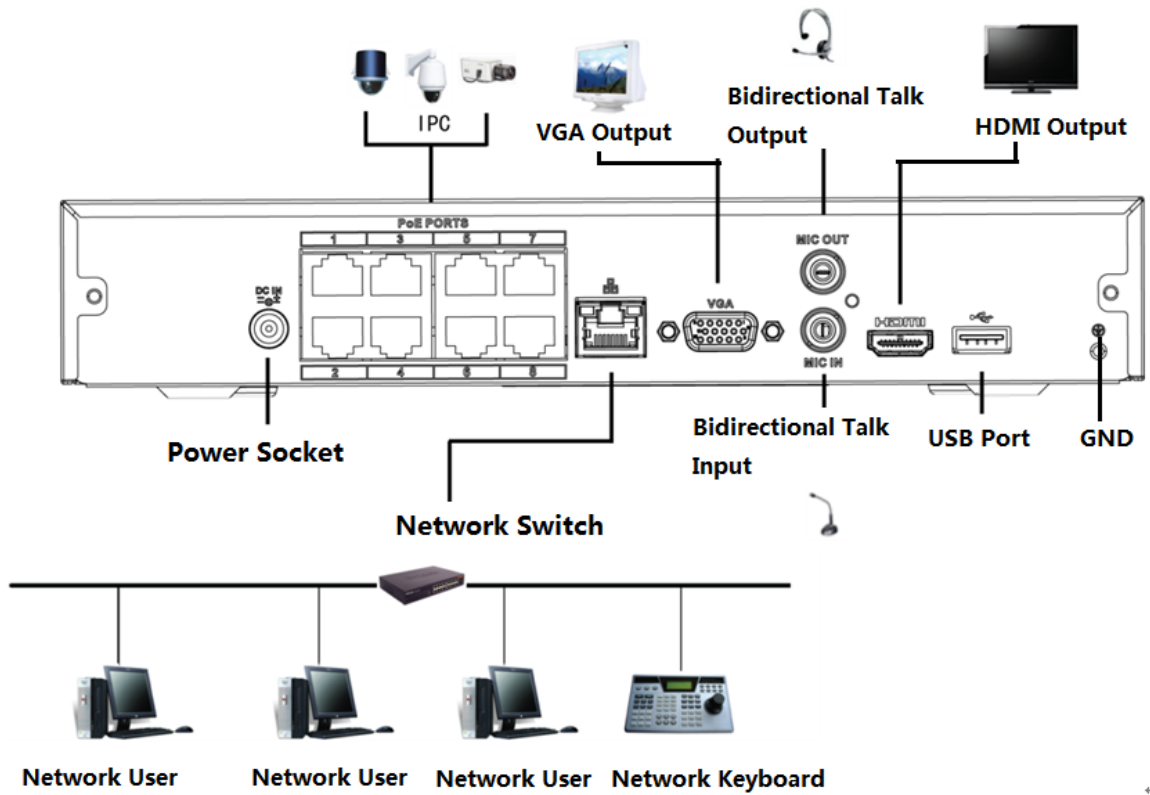

Figure 3-14

3.5.3 NVR2A16, NVR2B16 Series

Please refer to Figure 3-15 for connection sample.

The following figure for reference only.

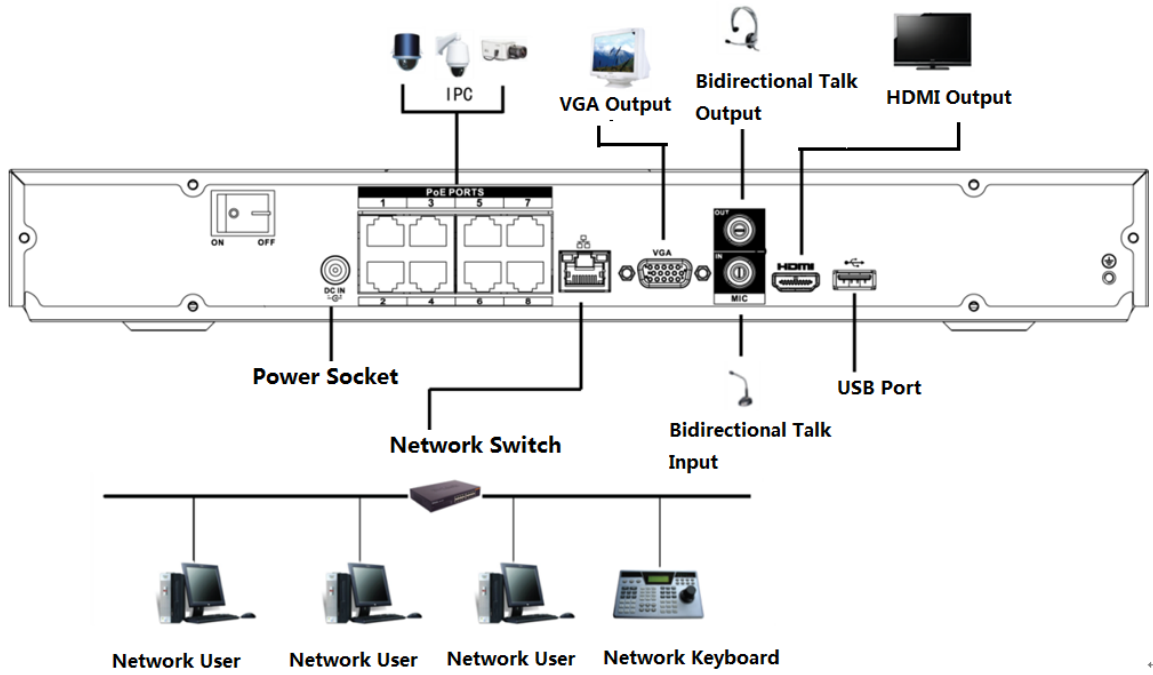

Figure 3-15

4 Local Basic Operation

Note

Slight difference may be found on the user interface. The following figures for reference only.

4.1 Getting Started

4.1.1 Boot up and Shut down

4.1.1.1 Boot up



Warning

Before the boot up, please make sure:

- For device security, please connect the NVR to the power adapter first and then connect the device to the power socket.
- The rated input voltage matches the device power on-off button. Please make sure the power wire connection is OK. Then click the power on-off button.
- Always use the stable current, if necessary UPS is a best alternative measure.

Please follow the steps listed below to boot up the device.

Step 1 Connect the device to the monitor and then connect a mouse.

Step 2 Connect power cable.

Step 3 Click the power button at the front or rear panel and then boot up the device. After device booted up, the system is in multiple-channel display mode by default.

4.1.1.2 Shutdown

Note

- When you see corresponding dialogue box “Saving data...” Do not click power on-off button directly.
- Do not unplug the power cable or click power on-off button to shutdown device directly when device is running (especially when it is recording.)

There are three ways for you to log out.

- a) Main menu (**RECOMMENDED**)

From Main Menu->Shutdown, select shutdown from dropdown list.

Click OK button, you can see device shuts down.

- b) From power on-off button on the rear panel.

4.1.2 Device Initialization

If it is your first time to use the device, please set a login password of **admin** (system default user). You can select to use unlock pattern to login or not at your own choosing.

Note

For your device safety, please keep your login password of **admin** well after the initialization steps, and change the password regularly.

Please follow the steps listed below.

Step 1 Boot up NVR.

Device displays device initialization interface. See Figure 4-1.

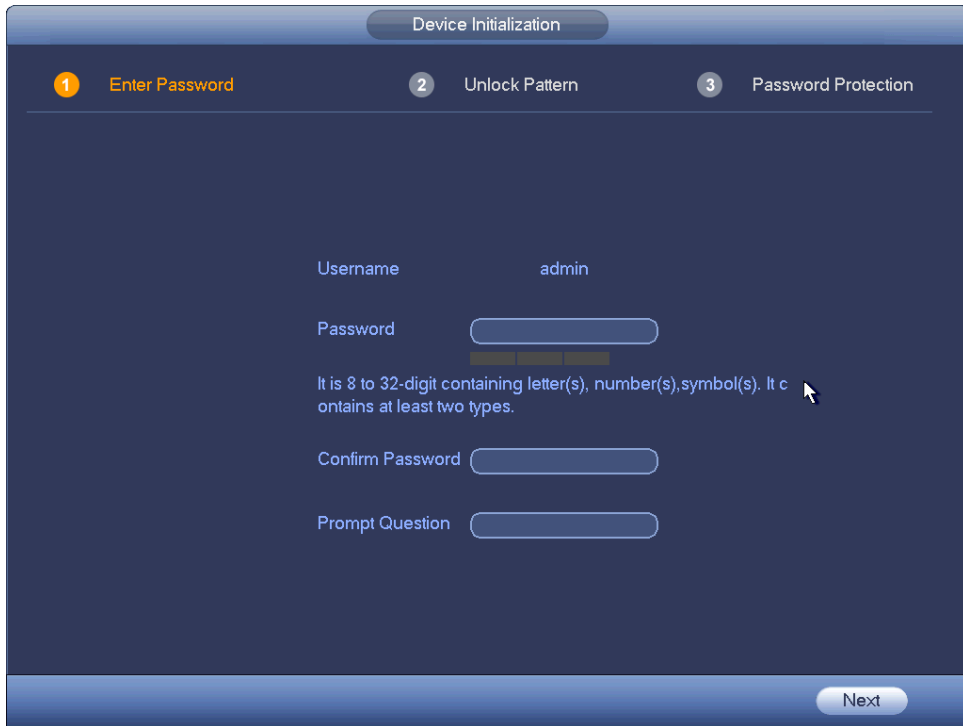



Figure 4-1

Step 4 Set login password of **admin**.

- User name: The default user name is **admin**.
- Password/confirm password: The password ranges from 8 to 32 digits. It can contain letters, numbers and special characters (excluding “”, “”, “;”, “:”, “&”) . The password shall contain at least two categories. Usually we recommend the strong password.
- Prompt question: If you set the prompt question here. On the login interface, move your mouse on , device can display the corresponding prompt question for you to remind the password.



WARNING

STRONG PASSWORD RECOMMENDED-For your device own safety, please create a strong password of your own choosing. We also recommend you change your password periodically especially in the high security system.

Step 5 Click Next, device goes to the following interface. See Figure 4-2.

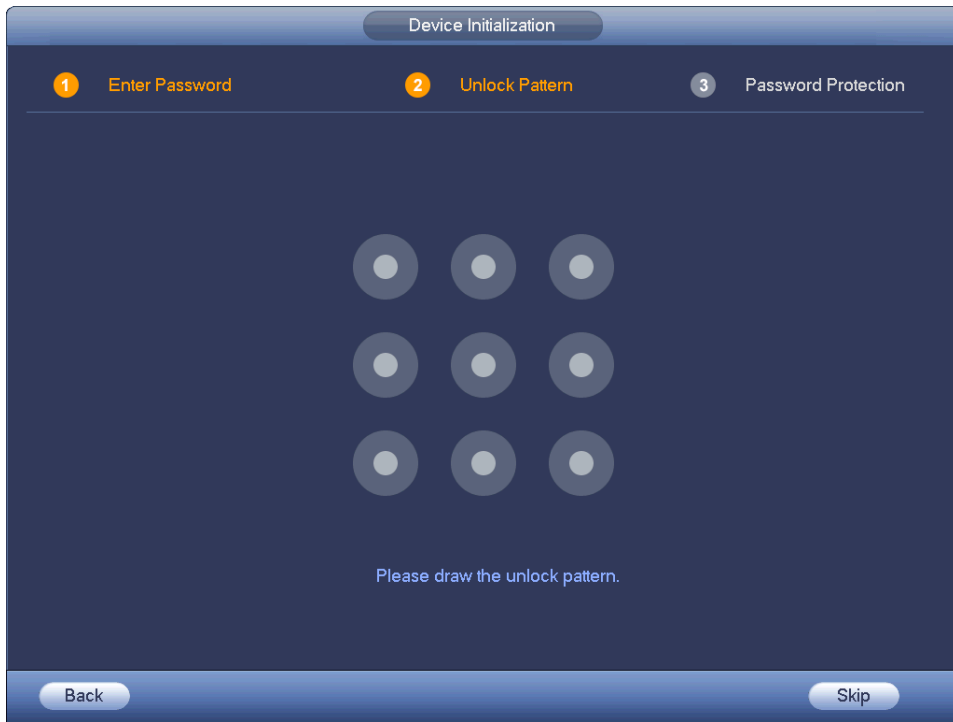

Figure 4-2

Step 6 Set unlock pattern.

After set unlock pattern, device goes to password protection interface. See Figure 4-3.

 **Note**

- Device adopts unlock pattern to login by default if you have set pattern here. If there is no unlock pattern, please input the password to login.
- Click Skip if there is no need to set unlock pattern.

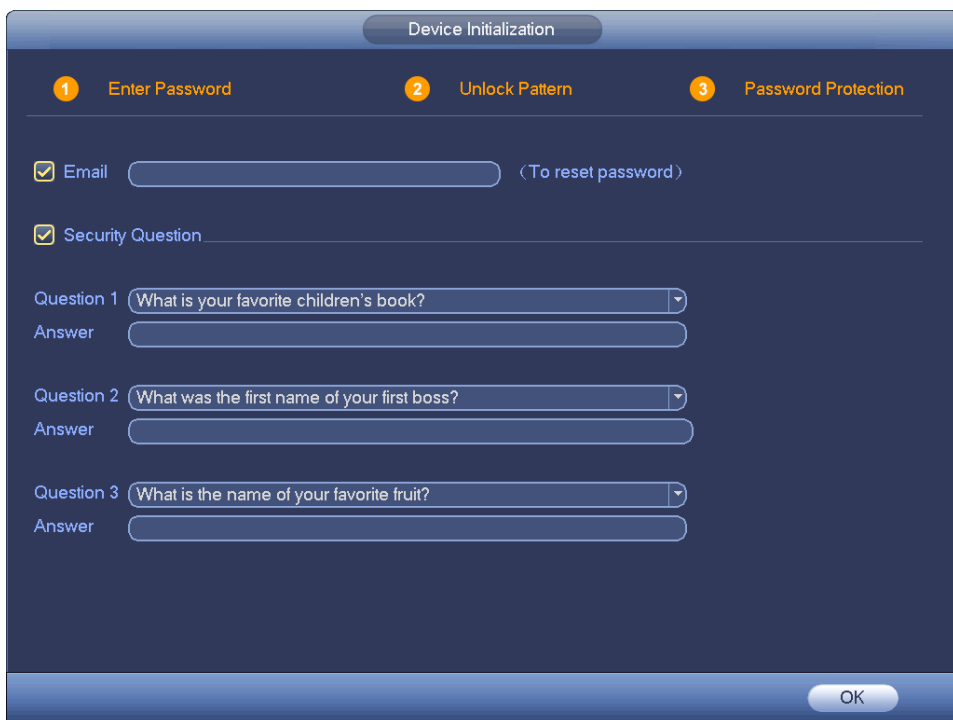

Figure 4-3

Step 7 Set security questions.

 **Note**

- After setting the security questions here, you can use the email you input here or answer the security questions to reset **admin** password. Refer to chapter 4.1.3 Reset password for detailed information.
- Cancel the email or security questions box and then click Next button to skip this step.
- Email: Input an email address for reset password purpose. In case you forgot password in the future, input the security code you got on the assigned email to reset the password of admin. If you have not input email here or you need to update the email information, please go to the main menu->Setting->System->Account to set. Refer to chapter 4.10.1.1.2 Modify User for detailed information.
- Security question: Set security questions and corresponding answers. Properly answer the questions to reset admin password. In case you have not input security question here or you need to update the security question information, please go to the main menu->Setting->System->Account->Security question to set. Refer to chapter 4.10.1.3 Security Question for detailed information.

 **Note**

If you want to reset password by answering security questions, please go to the local menu interface.

Step 8 Click OK to complete the device initialization setup.

Device goes to startup wizard interface. Refer to chapter 4.1.4 Quick Settings for detailed information.

4.1.3 Reset Password

If you forgot the admin password, you can reset the password by the following ways:

- When the password reset function is enabled, you can scan the QR code on the local interface to reset the password.
- When the password reset function is disabled, you can reset password via the security questions configured before. If the security questions are not configured, system displays that Password reset is closed! You need to contact the customer service for help.

Step 1 Go to the device login interface. See Figure 4-4 or Figure 4-5. .

- If you have set unlock pattern, device displays unlock pattern login interface. See Figure 4-4. Click "Forgot unlock pattern", device goes to Figure 4-5.
- If you have not set unlock pattern, device displays password interface. See Figure 4-5.

 **Note**

Click Switch user button, NVR goes to general user login interface. The default user name is **admin**. Click the user name and then select a user from the dropdown list; you can login via other account.

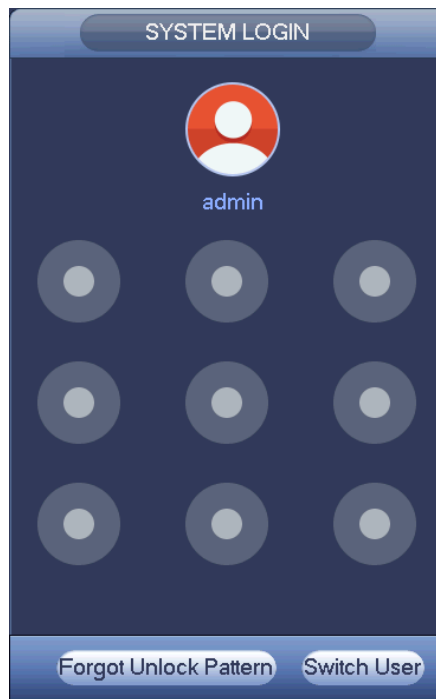

Figure 4-4



Figure 4-5

Step 2 Click .

- If you have not input email address information when you are initializing the device, the interface is shown as in Figure 4-6. Please input an email address, click Next button, and then device goes to Figure 4-7.
- If you have input email when you are initializing the device, device goes to Figure 4-7.

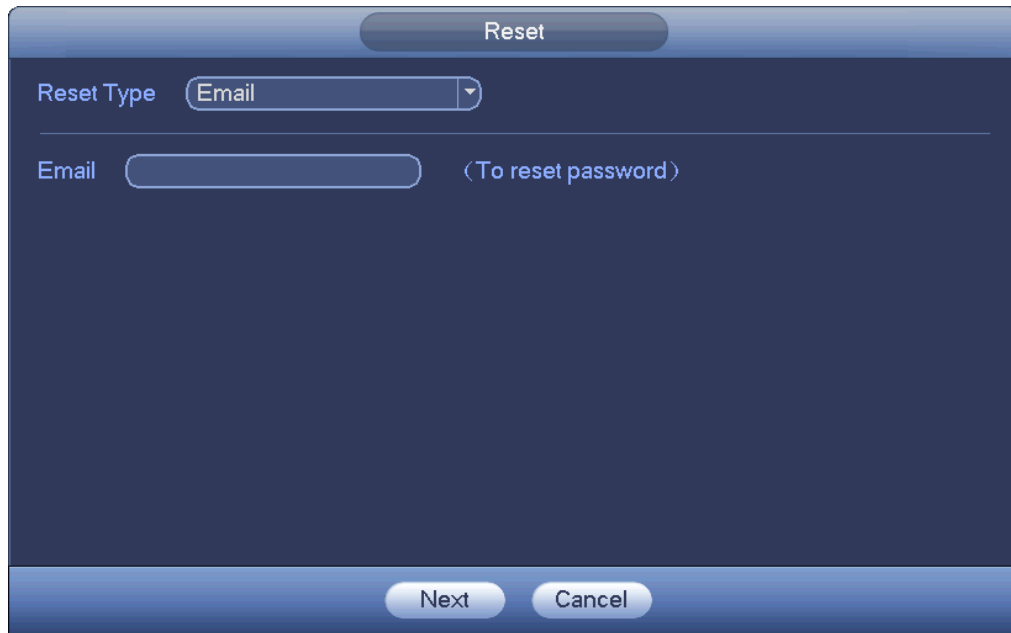

Figure 4-6



Figure 4-7

Step 3 Click OK button and device goes to Figure 4-8

 **NOTE**

After clicking OK, we will collect your personal information such as cell phone number, MAC address and device serial number. The collected information is used for verifying device legality and sending security code. Please read the notice carefully and confirm if you agree with the collection or not.



Figure 4-8

Step 4 Reset login password.

There are two ways to reset the password: Scan QR code and reset by email/security questions (local menu only)

- Email

In Figure 4-7, follow the prompts on the interface to scan the QR code, and then input the security code you get via the assigned email.

 **CAUTION**

- ✧ For the same QR code, max scan twice to get two security codes. Refresh the QR code if you want to get security code again.
- ✧ The security code on your email is only valid for 24 hours.

- Security questions

In Figure 4-6., select security question from the drop down list. Device displays security question interface. See Figure 4-9. Please input the correct answers here.

 **NOTE**

You shall configure the security questions before resetting password by answering the questions. If you have not configured the questions, this method will not be available in the drop-down list.

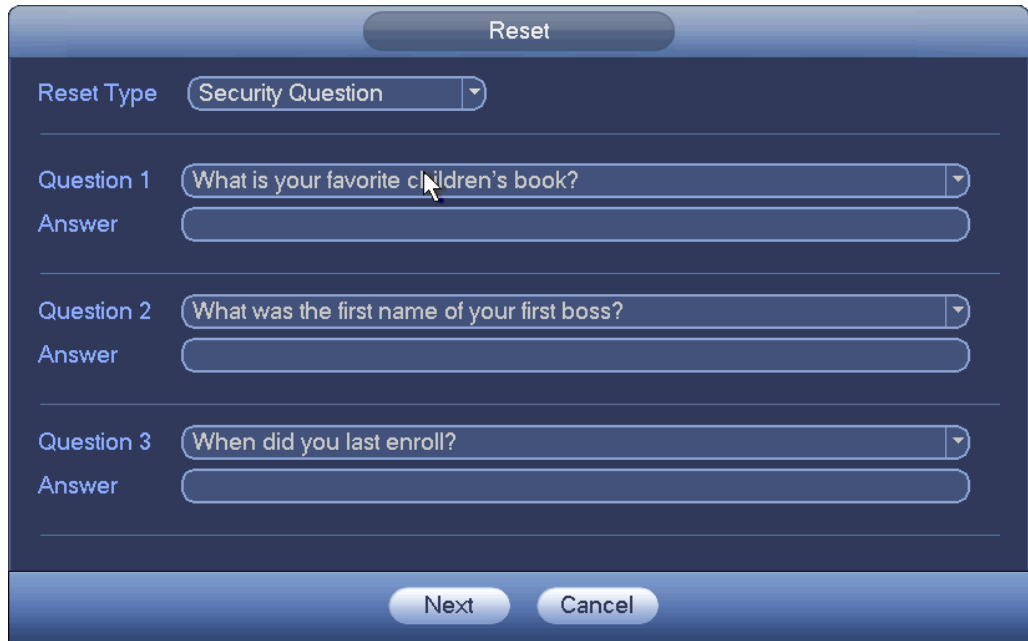

Figure 4-9

Step 5 Click Next button.

Device displays reset password interface. See Figure 4-10.

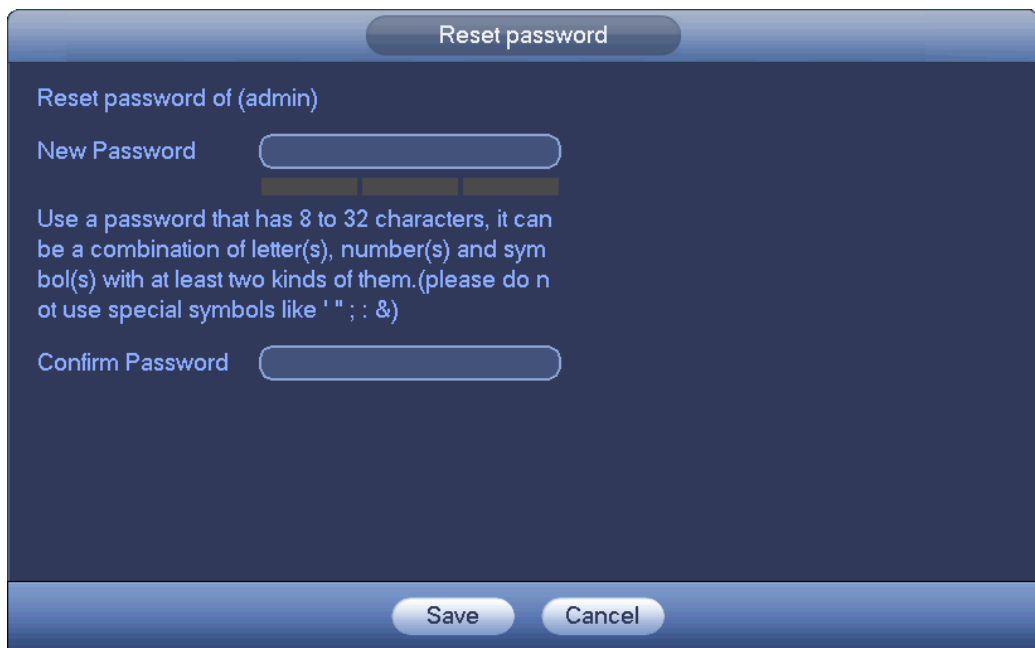

Figure 4-10

Step 6 Input new password and then confirm.

The password can be set from 8 characters through 32 characters and contain at least two types from number, letter and special character (excluding "", "", ";", ":" and "&"). It is recommended to set a password of high security according to the prompt.

Step 7 Click OK button to complete the setup.

4.1.4 Quick Settings

After you successfully initialize the device, it goes to startup wizard. Here you can quickly configure your

device. It includes general setup, basic network setup, camera registration, P2P, and schedule interface.

 **Note**

- Once the power is off during the quick settings process, you need to go through startup wizard again when the device boot up the next time.
- After completing all items on the startup wizard, the startup wizard automatically hides when the device boot up the next time.

Please follow the steps listed below.

Boot up the device and complete the device initialization. Device goes to startup wizard. See Figure 4-11.

- Select auto check, device automatically checks there is new applications or not every day.

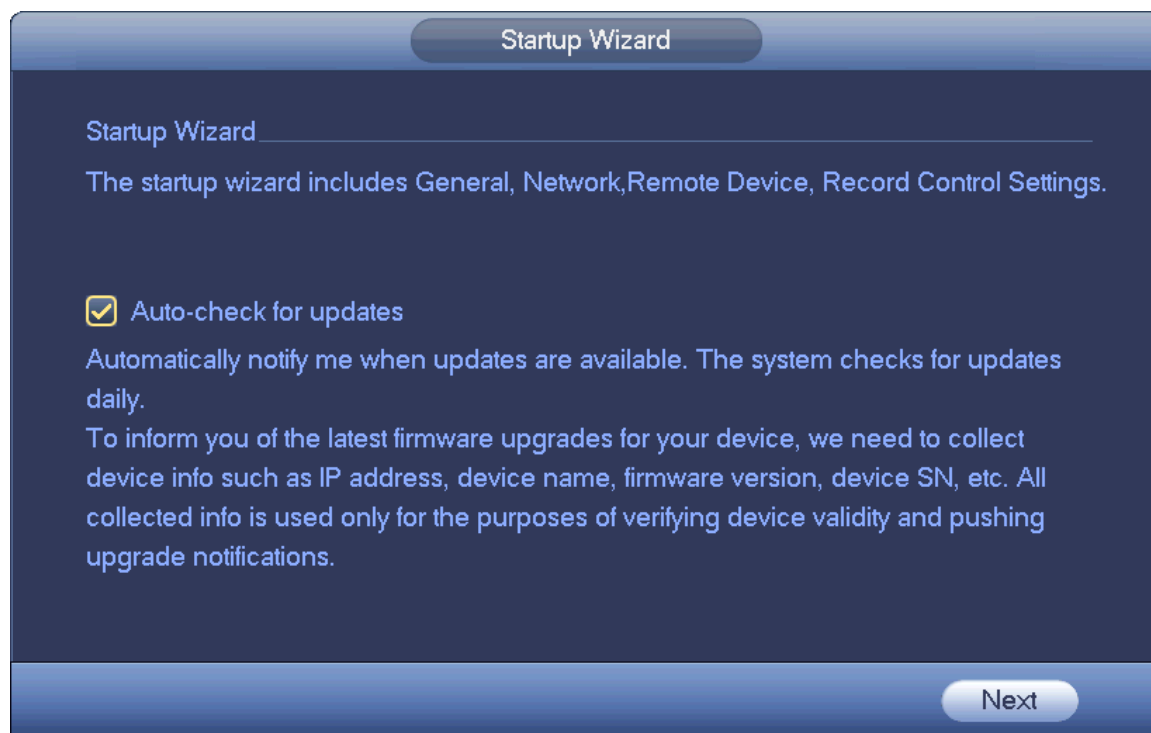

Figure 4-11

 **Note**

After auto-check is enabled, in order to inform you of the latest firmware upgrades, we will collect your personal information such as IP address, device name, firmware version and device SN. The collected information is used for verifying device legality and pushing upgrade notice.

4.1.4.1 General

It is to set NVR basic information such as system date, holiday and etc.

4.1.4.1.1 General

It is to set device basic information such as device name, serial number and etc.

Please follow the steps listed below.

Step 1 Click Next button,
Enter General interface.

Step 2 Click General button.
The interface is shown as below. See Figure 4-12.

 **Note**

From Main menu->Setting->System->General->General, you can go to the general interface.

Step 3 Set parameters.

- Device Name: Please input a corresponding device name here.
- Device No: When you are using one remote control (not included in the accessory bag) to control several NVRs, you can give a name to each NVR for your management.
- Language: System supports various languages: Chinese (simplified), Chinese (Traditional), English, Italian, Japanese, French, Spanish (All languages listed here are optional. Slight difference maybe found in various series.)
- Instant play: It is to set playback time you can view in the preview interface. The value ranges from 5 to 60 minutes.
- Auto logout: Here is for you to set auto logout interval once login user remains inactive for a specified time. Value ranges from 0 to 60 minutes.
- Monitor channels when logout: Here you can set channels you want to view when your account has logged out. Click the button and then cancel the channel name box, you need to login to view the corresponding video. The channel window displays  in preview interface.
- IPC Time Sync: You can input an interval here to synchronize the NVR time and IPC time.
- Mouse sensitivity: You can set double click speed via dragging the slide bard. You can Click Default button to restore default setup.



Figure 4-12

Step 4 Click Apply button to save settings.

4.1.4.1.2 Date and Time

Here you can set device time. You can enable NTP (Network Time Protocol) function so that the device

can sync time with the NTP server.

Step 1 Click Date and time button. See Figure 4-13.

 **Note**

From Main menu->Setting->System->General->Date and time, you can go to the date and time interface.

- System time: Here is for you to set system time
- Date format: There are three types: YYYY-MM-DD: MM-DD-YYYY or DD-MM-YYYY.
- Date separator: There are three denotations to separate date: dot, beeline and solidus.
- DST: Here you can set DST time and date by week or by date. Please enable DST function and then select setup mode. Please input start time and end time and click Save button.
- Time format: There are two types: 24-hour mode or 12-hour mode.
- NTP: It is to set NTP server, port and interval.



Warning

- ◇ System time is very important; do not modify time casually unless there is a must!
- ◇ Before your time modification, please stop record operation first!

Figure 4-13

Step 5 Click Apply button to save settings.

4.1.4.1.3 Holiday

Here you can add, edit, delete holiday. After you successfully set holiday information, you can view holiday item on the record and snapshot period.

Step 1 Click Holiday button. See Figure 4-14.

 **Note**

From Main menu->Setting->System->General->Holiday, you can go to the holiday interface.

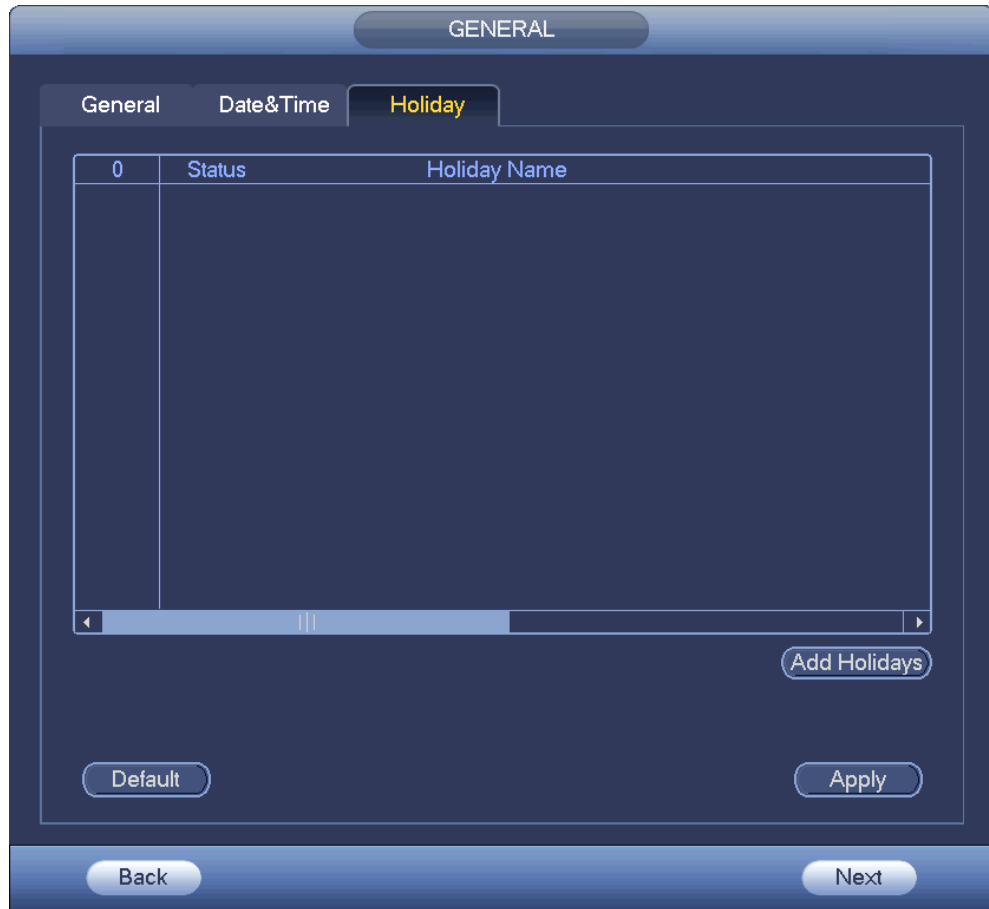

Figure 4-14

Step 2 Click Add new holiday button, device displays the following interface. See Figure 4-15.



Figure 4-15

Step 3 Set holiday name, repeat mode and holiday mode.



 **Note**

Click Add more to add new holiday information.

Step 4 Click Add button, you can add current holiday to the list.

 **Note**

✧ Click the dropdown list of the state; you can enable/disable holiday date.

✧ Click  to change the holiday information. Click  to delete current date.

Step 5 Click Apply button to save settings.

4.1.4.2 Basic Network Settings

Set device IP address, DNS (Domain Name System) information.

Preparation

Make sure the device has properly connected to the network.

Step 1 Click Next button, device goes to TCP/IP interface. See Figure 4-16.

 **Note**

✧ From Main menu->Setting->Network->TCP/IP, you can go to the TCP/IP interface.

✧ Different series products have different Ethernet adapter amount and type. Please refer to the actual product.



Figure 4-16

Step 2 Click , device display edit interface. See Figure 4-17.

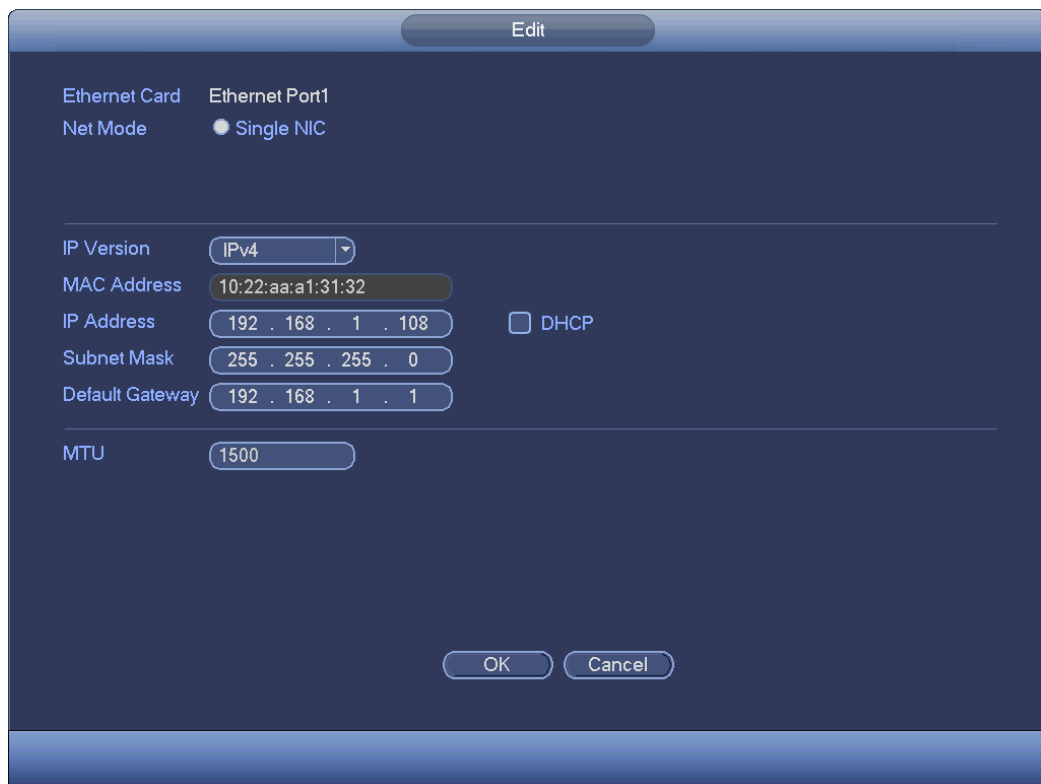

Figure 4-17

Step 3 Set parameters.

- IP Version: There are two options: IPv4 and IPv6. Right now, system supports these two IP address format and you can access via them.
- MAC address: The host in the LAN can get a unique MAC address. It is for you to access in the LAN. It is read-only.
- IP address: Here you can use up/down button (▲▼) or input the corresponding number to input IP address. Then you can set the corresponding subnet mask the default gateway.
- Default gateway: Here you can input the default gateway. Please note system needs to check the validity of all IPv6 addresses. The IP address and the default gateway shall be in the same IP section. That is to say, the specified length of the subnet prefix shall have the same string.
- MTU: It is to set MTU value of the network adapter. The value ranges from 1280-7200 bytes. The default setup is 1500 bytes.

Step 4 Click OK to complete the settings.

4.1.4.3 P2P

Click Next button, you can set P2P function. Scan the QR code, download the App to the cell phone, you can use the smart phone to add the device.

- Scan the QR code on the actual interface to download the cell phone app. Register an account and then use.
- Go to the www.easy4ip.com to register an account and use the SN to add a device. Refer to the P2P operation manual for detailed information.



Connect the NVR device to the Internet, otherwise P2P can not run properly.

Step 1 Enter from main menu -> Setting -> Network -> P2P.

The P2P interface is displayed. See Figure 4-18.



Figure 4-18

NOTE

- P2P is enabled by default.
- When P2P is enabled and the device is connected to the Internet, it displays Online in the Status box. We need to collect information like IP address, MAC address, device name and device SN. All collected information is used only for the purpose of remote access.

Step 2 Click Next to complete the setting.

If system displays Online in the Status box, P2P registration is successful.

Mobile APP Operation

The following contents are introduced in the example of mobile App.

Step 1 Scan the QR code to download and install the mobile App.

Step 2 Select Camera and enter the main interface.

Step 3 Register device in the mobile App:

- 1) Click  and select Device Manager. See Figure 4-19.

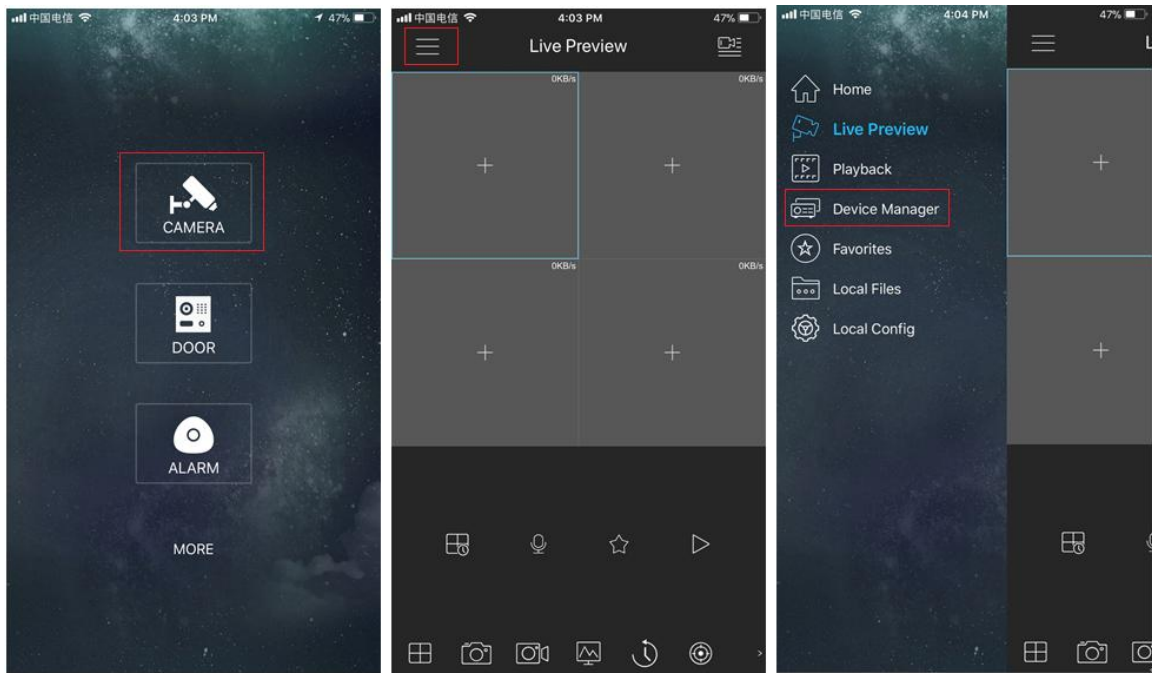



Figure 4-19

- 2) Click  and enter the Add Device interface.



NOTE

Mobile App supports device initialization.

- 3) Select Wired Device -> P2P to enter the P2P interface.
- 4) Click the QR code icon behind the SN to enter the QR code scan interface.
- 5) Scan the device label or scan the SN QR code got by entering from main menu -> Setup -> Network -> P2P. When the scan is successful, the device SN will be displayed in the SN item.
- 6) Enter name and password.

Step 4 After device registration on mobile App, click Start Preview and you can see the monitor screen.

4.1.4.4 Registration

After add remote device, the device can receive, storage, and manage the video streams of the remote device. You can view, browse, playback, manage several remote devices at the same time.

Step 1 On the P2P interface, click Next button.

Enter remote device interface. See Figure 4-20.



Note

There are two ways to go to Registration interface.

- From main menu->Setting->Camera->Registration, you can go to the registration interface.
- On the preview interface, right click mouse and then select Camera Registration.



Figure 4-20

Step 2 Set parameters

- Channel: It is the device channel number. If you have not added the network camera, the channel number is shown as --.
- Status: Red circle () means current channel has no video, green circle () means current channel has video.
- IP address: It is to display network camera IP address.
- Type: There are two connection types. You can use the network to connect to the camera or use the WIFI. The means current network camera connection mode is general; the means current network camera mode is hotspot.
- Add/Delete: Click to delete the device, click to add the device to the NVR.

Step 3 Add network camera.

- Device search: Click the button; you can search all network cameras in the same network segment. See Figure 4-21. Double click a camera or check the camera box and then click Add button; you can add a device to the list.

Note

The device in the added device list is not shown in the search result column.



Figure 4-21

- Manual Add: Click Manual Add button, you can set the corresponding network camera information and then select the channel you want to add. See Figure 4-22.
 - ✧ Manufacturer: Please select from the dropdown list.



Note

Different series products may support different manufactures, please refer to the actual product.

- ✧ IP address: Input remote device IP address.
- ✧ RTSP port: Input RTSP port of the remote device. The default setup is 554.



Note

Skip this item if the manufacture is Private or General.

- ✧ HTTP port: Input HTTP port of the remote device. The default setup is 80.



Note

Skip this item if the manufacture is ONVIF or General.

- ✧ TCP port: Input TCP port of the remote device. The default setup is 37777.
- ✧ User name/password: The user name and password to login the remote device.
- ✧ Channel No.: Input channel amount or click the Connect button to get the channel amount of the remote device.



Note

We recommend click Connect button to get remote device channel amount, the manual add operation may result in failure if the input channel amount is not right.

- ✧ Remote channel No.: After getting the remote device channel amount, click Setup to select a channel.



Note

Click to select one or more remote channel numbers here.

- ✧ Channel: The local channel number you want to add. One channel name has corresponding one channel number.
- ✧ Decode buffer: There are three items: realtime,local,fluent.
- ✧ Service type: There are four items: auto/TCP/UDP/MULTICAST(ONVIF device only)



Note

The default connection mode is TCP if the connection protocol is private.

There are four types including Auto, TCP, UDP and MULTICAST if the connection protocol is ONVIF.

There are two types including TCP and UDP if the connection protocol is customized.

- ✧ Encrypt: When the connection protocol is ONVIF, enable the encryption function and system transmits data in the encrypted mode.



Note

HTTPS shall be enabled in IPC to support encryption.



The screenshot shows a 'Manual Add' dialog box with the following fields and controls:

- Channel: D1 (dropdown)
- Manufacturer: Onvif (dropdown)
- CAM NAME: Channel 2 (text field) with a Save button
- IP Address: 192.168.0.0 (text field)
- RTSP Port: Customized (dropdown) and 554 (text field)
- HTTP Port: 80 (text field)
- Username: admin (text field)
- Password: (empty text field)
- Connect button
- Channel No.: 1 (text field) with a Setting button
- Remote Channel No.: 1 (dropdown)
- Decode Buffer: Default (dropdown)
- Encrypt: (checkbox)
- OK and Cancel buttons at the bottom

Figure 4-22

Step 4 Click OK to add the camera to the device.

 **Note**

Click  to change the remote device information. Click  to delete remote device. .

4.1.4.5 Schedule

After set record schedule and snapshot schedule, the device can automatically record video and snapshot image at the specified time.

4.1.4.5.1 Schedule Record

After set schedule record, device can record video file according to the period you set here. For example, the alarm record period is from 6:00~18:00 Monday, device can record alarm video files during the 6:00~18:00.

All channels are record continuously by default. You can set customized record period and record type.

Step 1 Click Next button.

Enter schedule interface. See Figure 4-23.

 **Note**





From main menu->Setting->Storage->Schedule->Record, you can go to the record interface.



Figure 4-23

Step 2 Set parameters.

- Channel: Please select the channel number first. You can select “all” if you want to set for the whole channels.

- ✧ : Sync connection icon. Select icon  of several dates, all checked items can be edited or together. Now the icon is shown as .
- ✧ : Click it to delete a record type from one period.
 - Record Type: Please check the box to select corresponding record type. There are four types: Regular/MD (motion detect)/Alarm/MD&Alarm.
 - Week day: There are eight options: ranges from Saturday to Sunday and all.
 - Holiday: It is to set holiday setup. Please note you need to go to the General interface (Main Menu->Setting->System->General) to add holiday first. Otherwise you cannot see this item.
 - Pre-record: System can pre-record the video before the event occurs into the file. The value ranges from 1 to 30 seconds depending on the bit stream.
 - Redundancy: System supports redundancy backup function. It allows you backup recorded file in two disks. You can highlight Redundancy button to activate this function. Please note, before enable this function, please set at least one HDD as redundant. (Main menu->Setting->Storage->HDD Manager). Please note this function is null if there is only one HDD.
 - ANR: It is to save video to the SD card of the network camera in case the network connection fails. The value ranges from 0s~43200s. After the network connection resumed, the system can get the video from the SD card and there is no risk of record loss.
- Period setup: Click button  after one date or a holiday, you can see an interface shown as in Figure 4-24. There are four record types: regular, motion detection (MD), Alarm, MD & alarm.

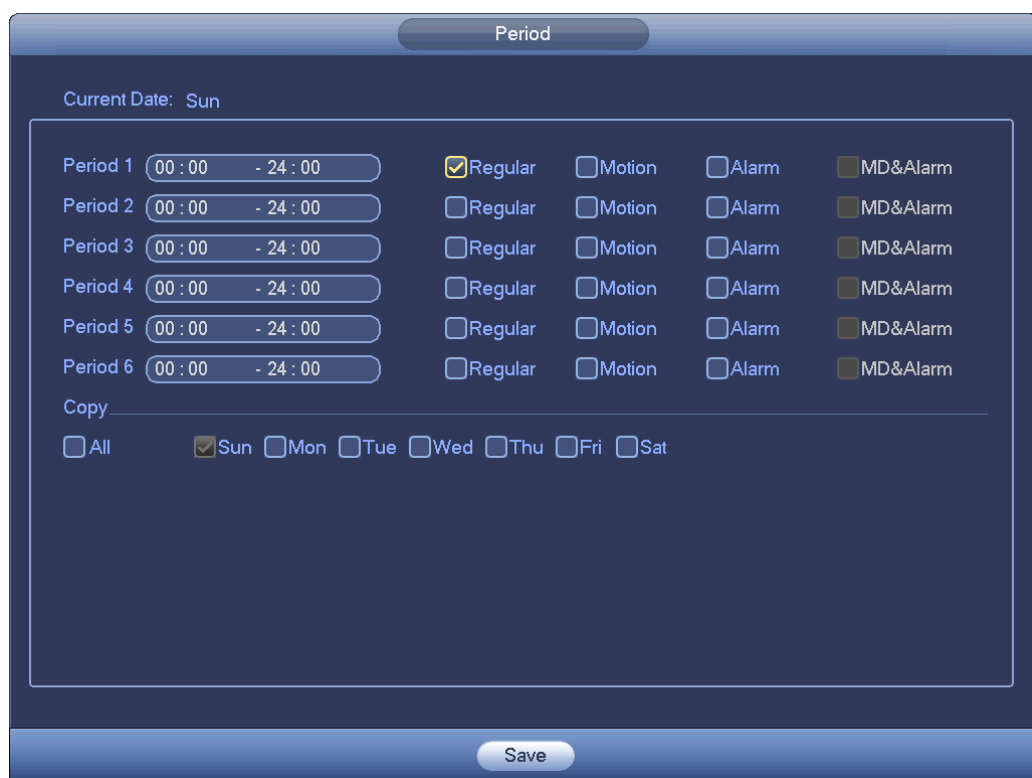

Figure 4-24

Please following the steps listed below to draw the period manually.

Step 1 Select a channel you want to set. See Figure 4-25.



Figure 4-25

Step 2 Set record type. See Figure 4-26.



Figure 4-26

 **Note**

- When the record type is MD (motion detect), alarm, MD&Alarm, please enable the channel record function when corresponding alarm occurs. For example, when the alarm type is MD, from main menu->Setting->Event->Video Detect->Motion Detect, please select the record channel and enable record function. See Figure 4-27.
- When the record type is MD (motion detect), alarm, MD&Alarm, refer to chapter 4.7.1 Video detect, chapter 4.7.2 Alarm Settings.

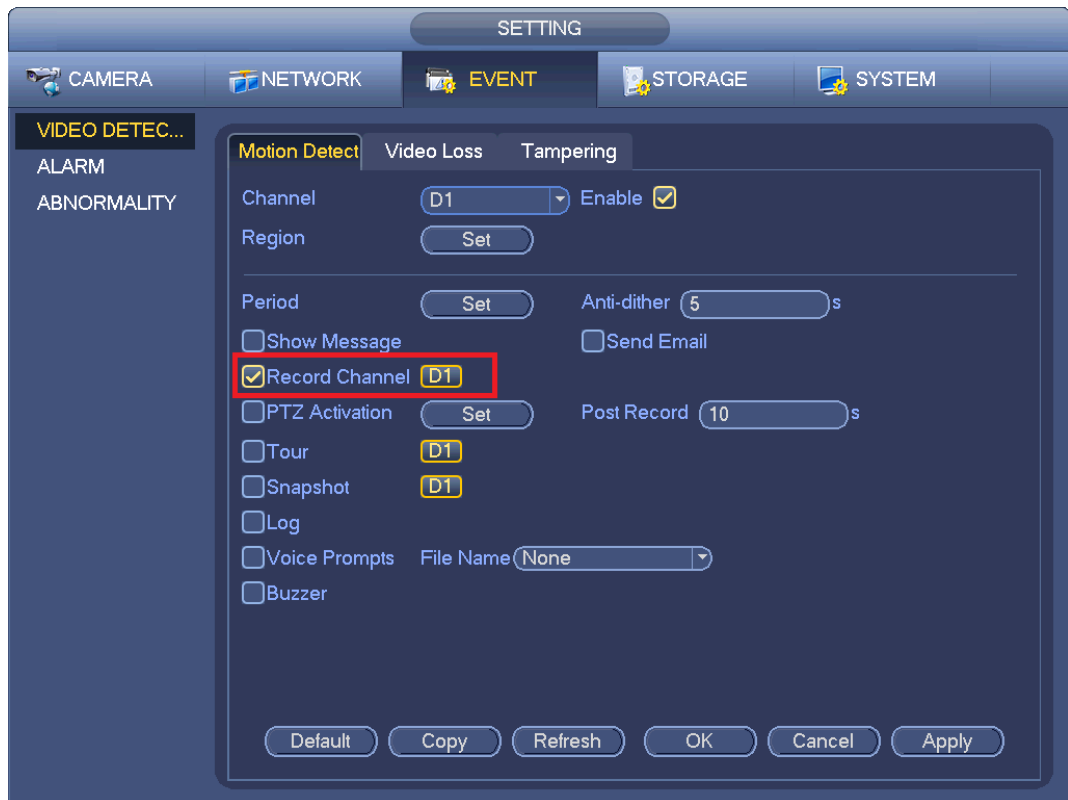

Figure 4-27

Step 3 Please draw manually to set record period. There are six periods in one day. See Figure 4-28.

 **Note**

If you have added a holiday, you can set the record period for the holiday.

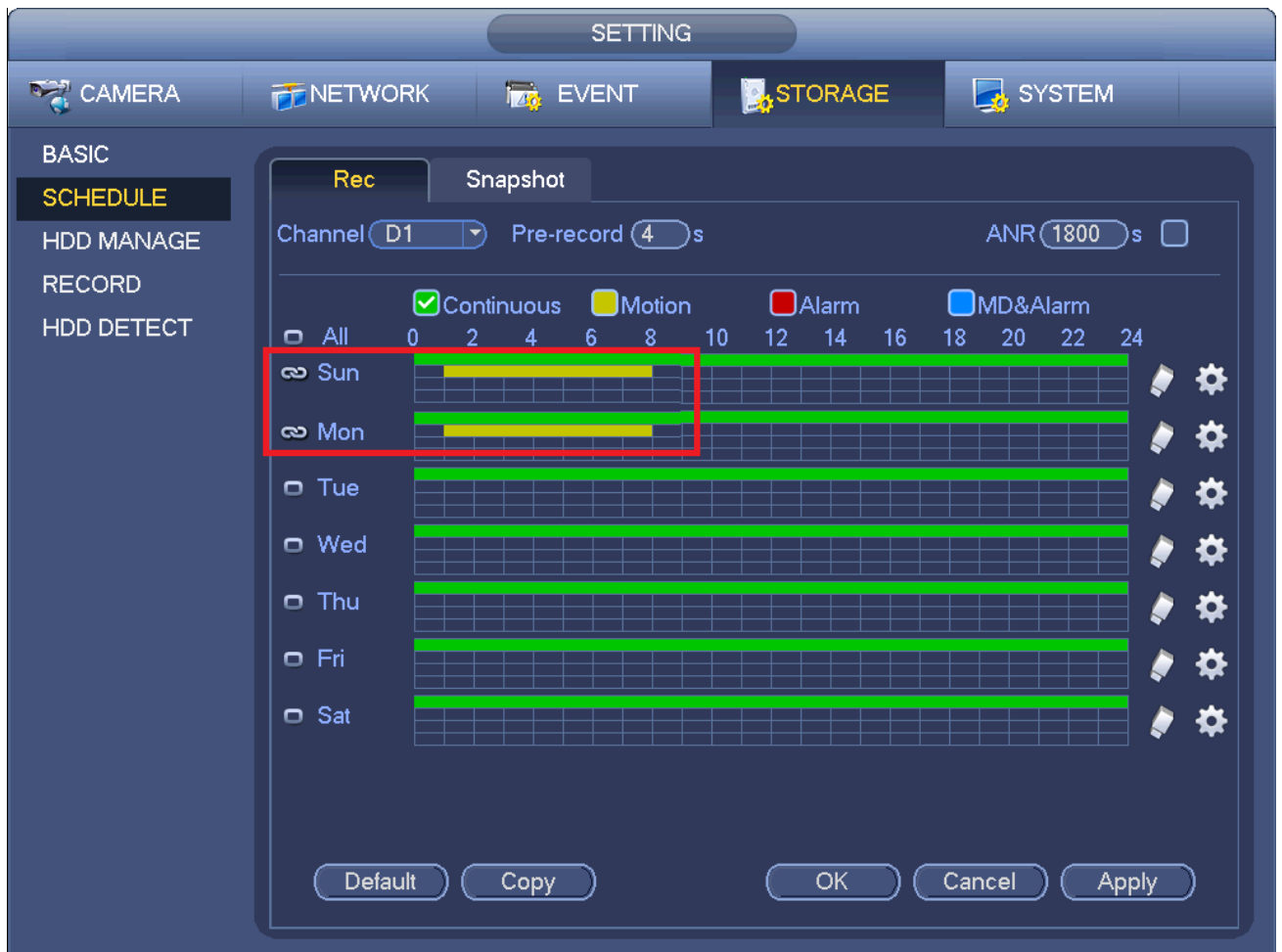

Figure 4-28

Step 4 Click Apply button to save schedule record settings.

 **Note**

Please enable auto record function so that the record plan can become activated. Refer to chapter 4.1.4.5.3 Record control for detailed information.

4.1.4.5.2 Schedule Snapshot

It is to set schedule snapshot period.

After set schedule snapshot, device can snapshot image according to the period you set here. For example, the alarm snapshot period is from 6:00~18:00 Monday, device can snapshot during the 6:00~18:00 when an alarm occurs.

Step 1 Click Snapshot button, device goes to following interface. See Figure 4-29.

 **Note**

From main menu->Setting->Storage->Schedule->Snapshot, you can go to the snapshot interface.



Figure 4-29

- Step 2 Select a channel to set schedule snapshot.
- Step 3 Set snapshot type as schedule. Refer to chapter 4.2.5.3 Snapshot for detailed information.
- Step 4 Check the box to set alarm type. See Figure 4-30.



Figure 4-30

Note

- When the record type is MD (motion detect), alarm, MD&Alarm, please enable the channel snapshot function when corresponding alarm occurs. For example, when the alarm type is MD, from main menu->Setting->Event->Video Detect->Motion Detect, please select the snapshot channel and enable snapshot function. See Figure 4-31.
- When the snapshot type is MD (motion detect), alarm, MD&Alarm, refer to chapter 4.7.1 Video detect, chapter 4.7.2 Alarm Settings.

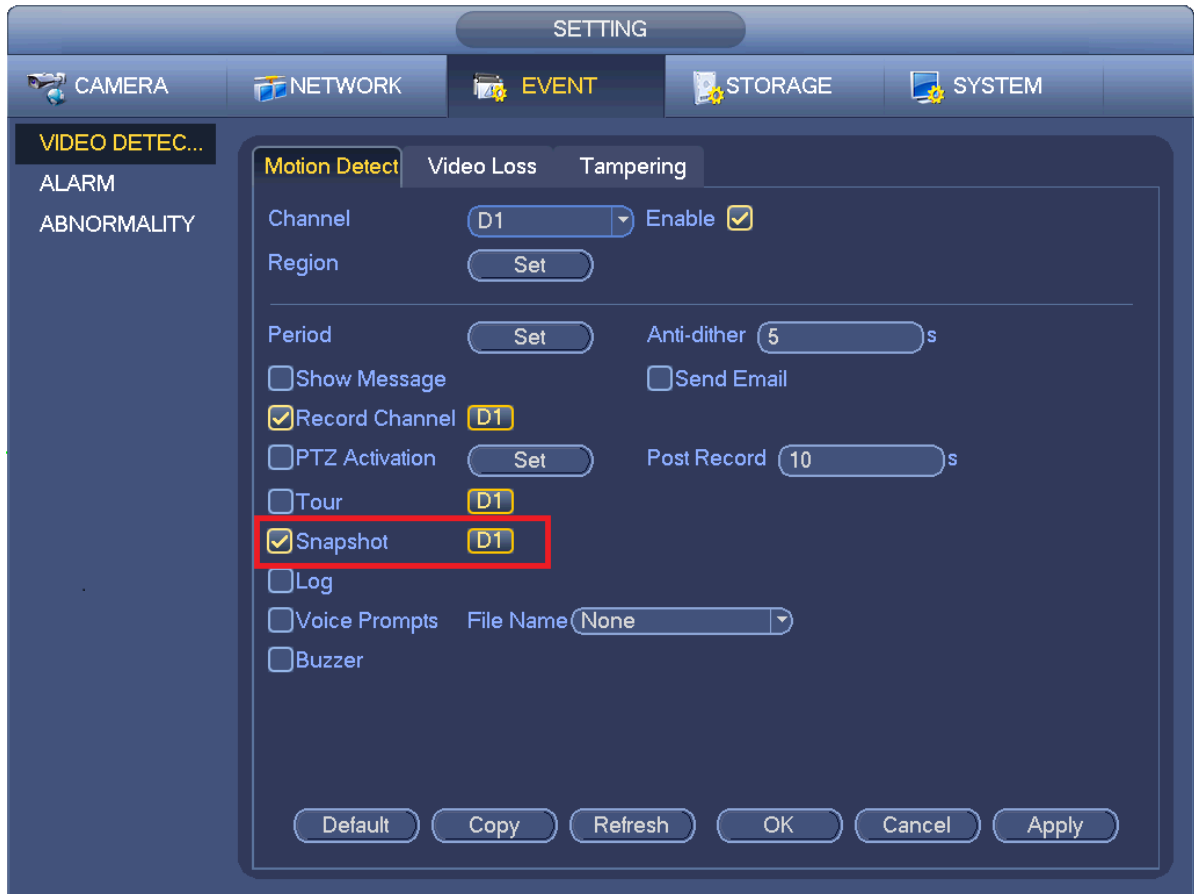

Figure 4-31

- Step 5 Refer to chapter 4.1.4.5.1 to set snapshot period.
- Step 6 Click Apply button to save snapshot plan.

Note

Please enable auto snapshot function so that the snapshot plan can become activated. Refer to chapter 4.1.4.5.3 Record control for detailed information.

- Step 7 Click Finish button, system pops up a dialogue box. Click the OK button, the startup wizard is complete. See Figure 4-32.



Figure 4-32

4.1.4.5.3 Record Control

Note

You need to have proper rights to implement the following operations. Please make sure the HDD has been properly installed.

There are two ways for you to go to record menu.

- Right click mouse and then select Manual->Record.
- In the main menu, from Setting->Storage->Record.

After set schedule record and schedule snapshot function, please enable auto record and auto snapshot function so that the device can automatically record and snapshot. System supports main stream and sub stream. There are three statuses: schedule/manual/stop. See Figure 4-33. Please highlight icon“○” to select corresponding channel.

- Manual: The highest priority. After manual setup, all selected channels will begin general recording.
- Auto: Channel records as you have set in recording setup (Main Menu->Setting->Storage->>Schedule)
- Off: Current channel stops recording.
- All: Check All button after the corresponding status to enable/disable all-channel schedule/manual record or enable/disable all channels to stop record.
- Snapshot: Select one or more channel(s) first and then enable/disable schedule snapshot function.



Figure 4-33

4.1.4.5.4 Record Info

After system recorded video files, go to the record info interface to view device name, start time, end time and etc.

From main menu->Info-System->Record, the interface is shown as below. See Figure 4-34.

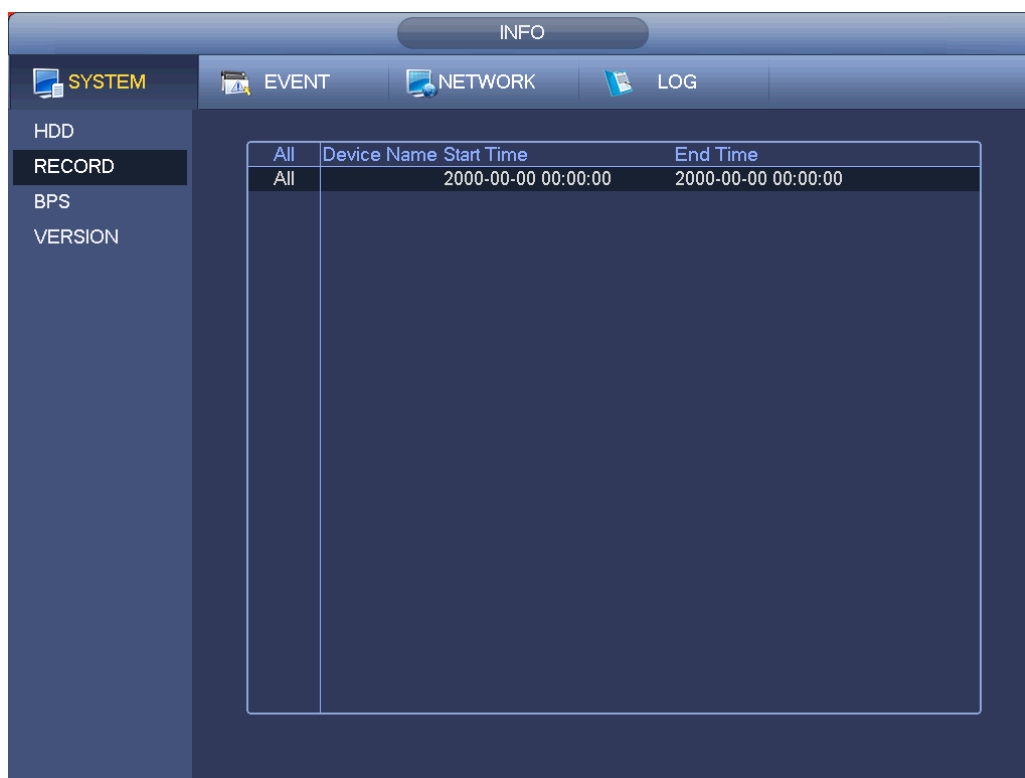

Figure 4-34

4.2 Camera

4.2.1 Connection

After register a remote device to the NVR, you can view the video on the NVR, and manage and storage the video file. Different series products support different remote device amount. Refer to chapter 4.1.4.4 Registration to add a camera.

4.2.1.1 Change IP address

Step 1 From Main menu->Setting->Camera->Registration, check the box before the camera name and

then click Change IP or click the  before the camera name.

Enter change IP interface. See Figure 4-35.

Note

Check the box before several cameras, change the IP addresses of several cameras at the same time.

IP Setting

Checked Device No.: 1

DHCP

STATIC

User Name

Password

Incremental Value

IP Address

Subnet Mask

Default Gateway

1	Serial No.	IP Address
1	2F00834PAMV/M5PP	10.15.5.111

Save Cancel

Figure 4-35

Step 2 Select IP mode.

Check DHCP, there is no need to input IP address, subnet mask, and default gateway. Device automatically allocates the IP address to the camera.

Check Static, and then input IP address, subnet mask, default gateway and incremental value.

 **Note**

If it is to change several devices IP addresses at the same time, please input incremental value. Device can add the fourth address of the IP address one by one to automatically allocate the IP addresses.

If there is IP conflict when changing static IP address, device pops up IP conflict dialogue box. If batch change IP address, device automatically skips the conflicted IP and begin the allocation according to the incremental value

Step 3 Input remote device user name and password.

Step 4 Click OK button to save settings.

After the changing operation, search again, device displays new IP address.

 **Note**

When change IP addresses of several devices at the same time, make sure the cameras user name and passwords are the same.

4.2.2 Remote Device Initialization

Remote device initialization can change remote device login password and IP address.

 **Note**

- When connect a camera to the NVR via PoE port, NVR automatically initialize the camera. The camera adopts NVR current password and email information by default.
- When connect a camera to the NVR via PoE port after NVR upgraded to the new version, the NVR may fail to initialize the camera. Please go to the Registration interface to initialize the camera.

- Step 1 From main menu->Setting->Camera->Registration.
Enter Registration interface.
- Step 2 Click Device Search and then click Uninitialized.
Device displays camera(s) to be initialized.
- Step 3 Select a camera to be initialized and then click Initialize.
Device displays password setup interface. See Figure 4-36.

 **Note**

- If you want to use current device password and email information, the remote device automatically uses NVR admin account information (login password and email). There is no need to set password and email. Please go to step 4.

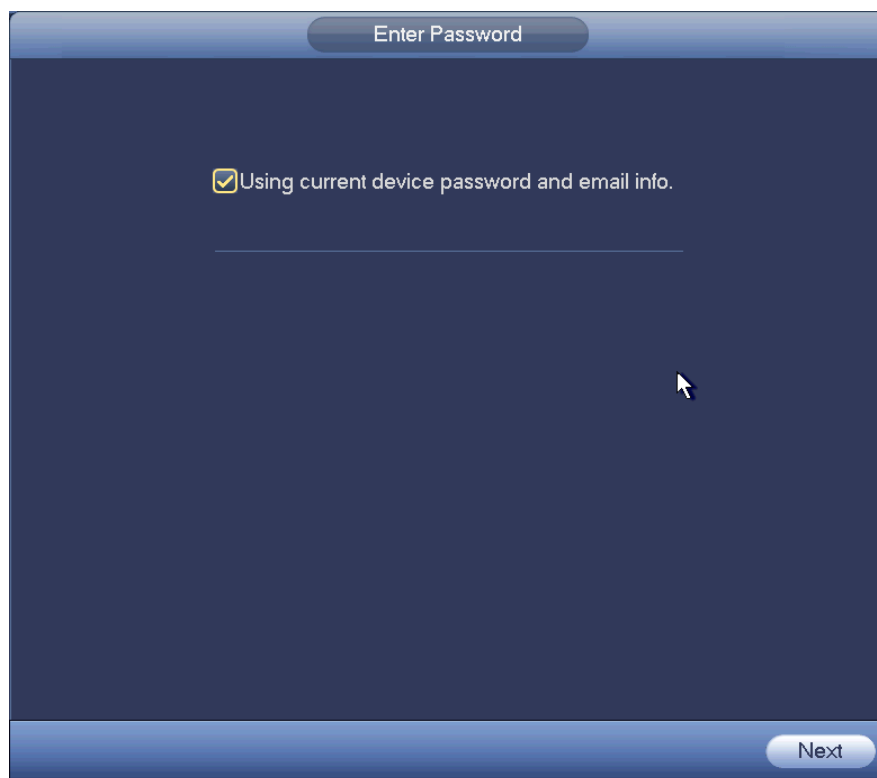

Figure 4-36

1. Cancel using current device password and email information, Enter password setting interface. See Figure 4-37.

Enter Password

Using current device password and email info.

Username admin

Password

It is 8 to 32-digit containing letter(s), number(s),symbol(s). It contains at least two types.

Confirm Password

Next

Figure 4-37

2. Set camera password.

- The user name is **admin**. The password ranges from 8 to 32 digitals. It can contain letters, numbers and special characters (excluding “”, “'”, “;”, “:”, “&”) . The password shall contain at least two categories. Usually we recommend the strong password.

 **CAUTION**

STRONG PASSWORD RECOMMENDED-For your device own safety, please create a strong password of your own choosing. We also recommend you change your password periodically especially in the high security system.

3. Click Next button.

Enter input email interface. See Figure 4-38.

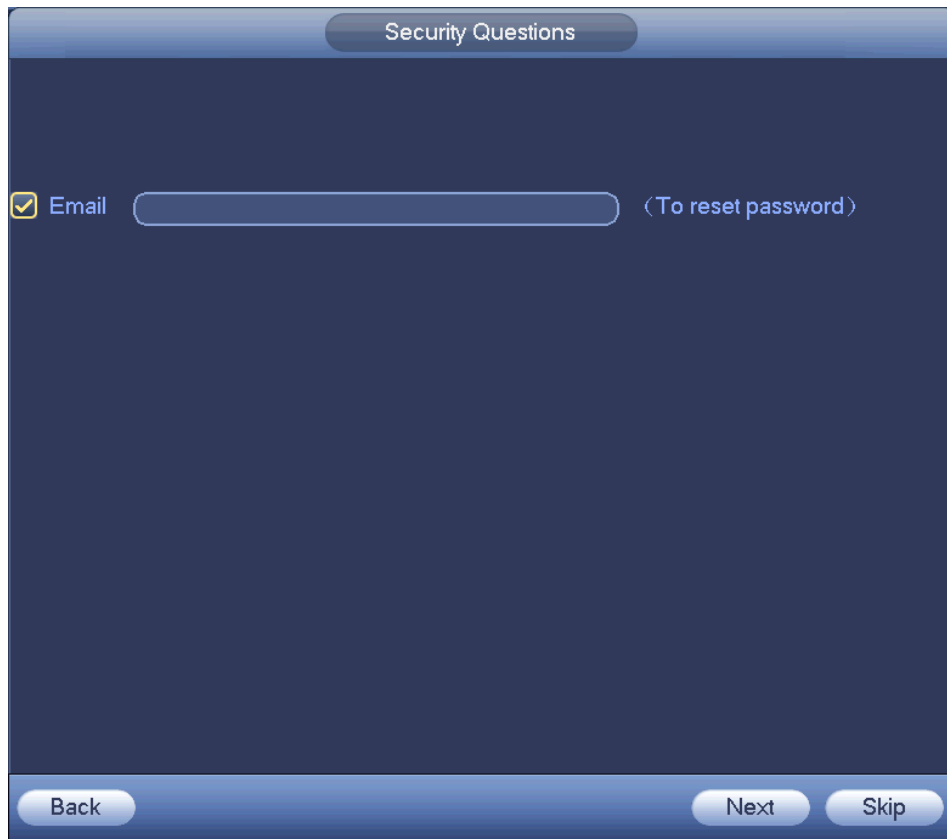

Figure 4-38

4. Set email information.

Email: Input an email address for reset password purpose.

 **Note**

Cancel the box and then click Next or Skip if you do not want to input email information here.

Step 4 Click Next button.

Enter Change IP address interface. See Figure 4-39.

IP Setting

Checked Device No.: 1

DHCP

STATIC

User Name

Password

IP Address

Subnet Mask

Default Gateway

Incremental Value

1	Serial No.	IP Address
1	2F00834PAMVM5PP	10.15.5.111

Save Cancel

Figure 4-39

Step 5 Set camera IP address

Check DHCP, there is no need to input IP address, subnet mask, and default gateway. Device automatically allocates the IP address to the camera.

Check Static, and then input IP address, subnet mask, default gateway and incremental value.

 **Note**

- If it is to change several devices IP addresses at the same time, please input incremental value. Device can add the fourth address of the IP address one by one to automatically allocate the IP addresses.
- If there is IP conflict when changing static IP address, device pops up IP conflict dialogue box. If batch change IP address, device automatically skips the conflicted IP and begin the allocation according to the incremental value

Step 6 Click Next button.

Device begins initializing camera. See Figure 4-40.

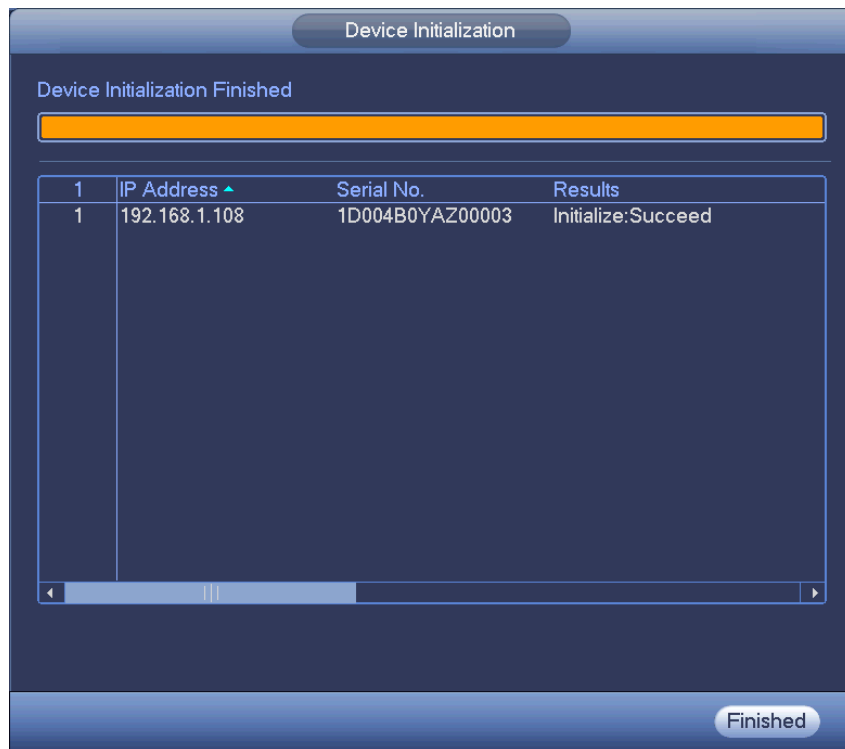

Figure 4-40

Step 7 Click Finish to complete the setup.

4.2.3 Short-Cut Menu to Register Camera

If you have not registered a remote device to a channel, please go to the preview interface to add.

Step 1 On the preview interface,

Move your mouse to the center, there is an icon "+". See Figure 4-41.

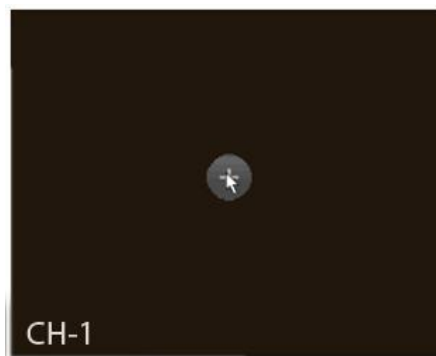

Figure 4-41

Step 2 Click "+", device pops up interface to add network camera. Refer to chapter 4.1.4.4 Registration for detailed information.

4.2.4 Image

It is to set network camera parameters according to different environments. It is to get the best video effect.

From main menu->setting->camera->image, you can see the image interface is shown as below. See Figure 4-42.

- Channel: Select a channel from the dropdown list.
- Saturation: It is to adjust monitor window saturation. The value ranges from 0 to 100. The default value is 50. The larger the number, the stronger the color is. This value has no effect on the general brightness of the whole video. The video color may become too strong if the value is too high. For the grey part of the video, the distortion may occur if the white balance is not accurate. Please note the video may not be attractive if the value is too low. The recommended value ranges from 40 to 60.
- Brightness: It is to adjust monitor window bright. The value ranges from 0 to 100. The default value is 50. The larger the number is, the brighter the video is. When you input the value here, the bright section and the dark section of the video will be adjusted accordingly. You can use this function when the whole video is too dark or too bright. Please note the video may become hazy if the value is too high. The recommended value ranges from 40 to 60.
- Contrast: It is to adjust monitor window contrast. The value ranges from 0 to 100. The default value is 50. The larger the number is, the higher the contrast is. You can use this function when the whole video bright is OK but the contrast is not proper. Please note the video may become hazy if the value is too low. If this value is too high, the dark section may lack brightness while the bright section may over exposure. The recommended value ranges from 40 to 60.
- Auto Iris: It is for the device of the auto lens. You can check the box before ON to enable this function. The auto iris may change if the light becomes different. When you disable this function, the iris is at the max. System does not add the auto iris function in the exposure control. This function is on by default.
- Mirror: It is to switch video up and bottom limit. This function is disabled by default.
- Flip: It is to switch video left and right limit. This function is disabled by default.
- BLC: It includes several options: BLC/WDR/HLC/OFF.
- ✧ BLC: The device auto exposures according to the environments situation so that the darkest area of the video is cleared
- ✧ WDR: For the WDR scene, this function can lower the high bright section and enhance the brightness of the low bright section. So that you can view these two sections clearly at the same time. The value ranges from 1 to 100. When you switch the camera from no-WDR mode to the WDR mode, system may lose several seconds record video.
- ✧ HLC: After you enabled HLC function, the device can lower the brightness of the brightest section according to the HLC control level. It can reduce the area of the halo and lower the brightness of the whole video.
- ✧ OFF: It is to disable the BLC function. Please note this function is disabled by default.
- Profile: It is to set the white balance mode. It has effect on the general hue of the video. This function is on by default. You can select the different scene mode such as auto, sunny, cloudy, home, office, night, disable and etc to adjust the video to the best quality.
- ✧ Auto: The auto white balance is on. System can auto compensate the color temperature to make sure the video color is proper.
- ✧ Sunny: The threshold of the white balance is in the sunny mode.
- ✧ Night: The threshold of the white balance is in the night mode.
- ✧ Customized: You can set the gain of the red/blue channel. The value ranges from 0 to 100.
- Day/night. It is to set device color and the B/W mode switch. The default setup is auto.
- ✧ Color: Device outputs the color video.
- ✧ Auto: Device auto select to output the color or the B/W video according to the device feature (The general bright of the video or there is IR light or not.)
- ✧ B/W: The device outputs the black and white video.

- ✧ Sensor: It is to set when there is peripheral connected IR light.
Please note some non-IR series product support sensor input function.

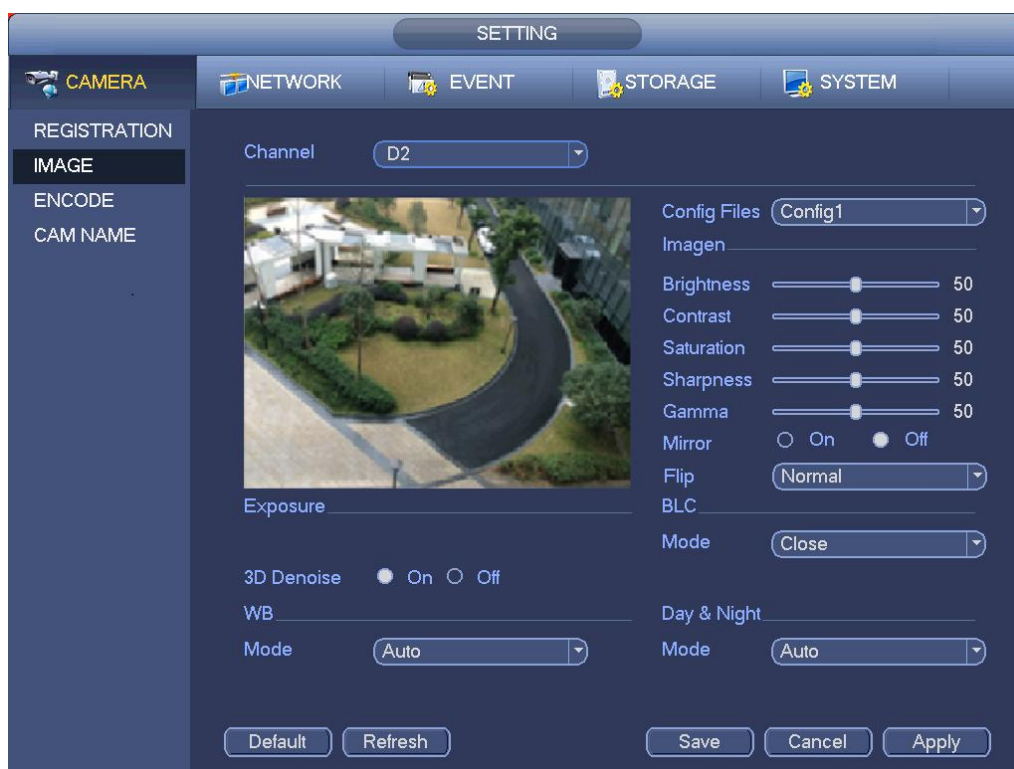

Figure 4-42

4.2.5 Encode

It is to set video encode parameters such as video bit rates, video overlay, snapshot settings.

4.2.5.1 Encode

It is to set IPC encode mode, resolution, bit stream type and etc.

Note

Some series products support three streams: main stream, sub stream 1, sub stream 2. The sub stream maximally supports 1080P.

From Main menu->Setting->System->Encode, you can see the following interface. See Figure 4-43.

- Channel: Select the channel you want.
- Type: It is to set device bit stream type.
- ✧ For main stream, there are three options: regular/motion detect/alarm. The sub stream supports regular bit streams only.
- ✧ The active control frame function (ACF) can record in different frame rates. For example, you can use high frame rate to record important events, record scheduled event in lower frame rate.
- ✧ Set different frame rates for different record events.

Note

Some series products do not support motion detect bit streams and alarm streams.

- Compression: Video encode mode.
- ✧ H.264: Main Profile encode mode.
- ✧ H.264H: High Profile encode mode.

- ✧ H.264B: Baseline Profile encode mode.
- ✧ H.265: Main Profile encode mode.
- ✧ MJPEG: System needs high bit streams to guarantee video definition. Use the recommended max bit stream value to get the better video effect.
- Smart Codec: This function is to reduce bit streams.

 **Note**

- ✧ Some series products support smart codec function.
- ✧ After changing smart code, please reboot network camera and some network camera functions (such as IVS, ROI, SVC, lobby mode and etc.) becomes null. Please think twice before the operation.
- Resolution: The resolution here refers to the capability of the network camera.

 **Note**

Different series products support different resolutions. Please refer to the actual interface for detailed information.

- Frame rate (FPS): The video frame amount displayed in each second. The higher the frame rate is, the clearer and more fluent the video is. The frame rate may vary depending on the resolution.
- Bit rate type: System supports two types: CBR and VBR.
 - ✧ Main stream: It is to set frame rate to change video quality. The higher the frame rate is, the better the video quality is. The referenced bit rate is the recommended value.
 - ✧ Sub stream: In CBR mode, the bit stream is near the specified value. In VBR mode, the video quality changes according to the bit stream value. But its max value is near the specified value.
- Reference bit rate: The reference bit rate depends on the resolution and frame rate you set.
- Video/audio: You can enable or disable the video/audio. The main stream is enabled by default. After enable the audio function, the record file is composite file consisting of the video and audio. For the sub stream 1, please enable video first and then enable audio function.
- Audio format: Set audio encode format.

 **Note**

Different series products support different audio encode mode. Please refer to the actual interface for detailed information.

- Sampling rate: Audio sampling rate refers to the sampling amount within 1 second. The higher the value is, the better the audio is. The default setup is 8K.
- Copy: After you complete the setup, you can click Copy button to copy current setup to other channel(s). You can see an interface is shown as in Figure 4-46. You can see current channel number is grey. Please check the number to select the channel or you can check the box ALL. Please click the OK button in Figure 4-46 and Figure 4-44 respectively to complete the setup. Please note, once you check the All box, you set same encode setup for all channels. Audio/video enable box, overlay button and the copy button is shield.

Please highlight icon  to select the corresponding function.



Figure 4-43

4.2.5.2 Overlay

Click overlay button, you can see an interface is shown in Figure 4-44.

- Cover area: Here is for you to cover area section. You can drag you mouse to set proper section size. In one channel video, system max supports 4 zones in one channel. You can set with Fn button or direction buttons.
- Preview/monitor: The cover area has two types. Preview and Monitor. Preview means the privacy mask zone cannot be viewed by user when system is in preview status. Monitor means the privacy mask zone cannot be view by the user when system is in monitor status.
- Time display: You can select system displays time or not when you playback. Please click set button and then drag the title to the corresponding position in the screen.
- Channel display: You can select system displays channel number or not when you playback. Please click set button and then drag the title to the corresponding position in the screen.



Figure 4-44

4.2.5.3 Snapshot

Here you can set snapshot mode, picture size, quality and frequency. See Figure 4-45.

- Snapshot mode: There are two modes: Timing and Trigger. If you set timing mode, you need to set snapshot frequency. If you set trigger snapshot, you need to set snapshot activation operation.
- Image size: Here you can set snapshot picture size.
- Image quality: Here you can set snapshot quality. The value ranges from 1 to 6.
- Snapshot frequency: It is to set snapshot interval at timing mode.



Figure 4-45

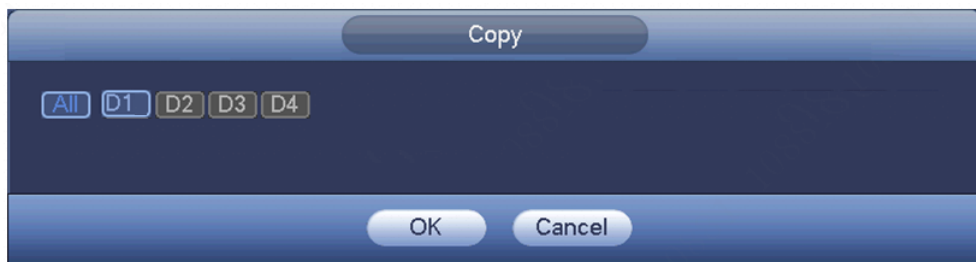

Figure 4-46

4.2.6 Channel Name

From main menu->Setting->Camera-Channel name, you can see an interface shown as in Figure 4-47. It is to modify channel name. It max supports 63-character.

Please note you can only modify the channel name of the connected network camera.



Figure 4-47

4.2.7 Remote Upgrade

It is to upgrade the connected network camera firmware. It includes online upgrade and file upgrade. From main menu->setting->camera->registration, the interface is shown as below. See Figure 4-48.



Figure 4-48

Online Upgrade

Step 1 Select a remote device and then click the Detect button on the right side, or check a box to select a remote device and then click Manual Check.

System detects the new version on the cloud.

Step 2 Select a remote device that has new version and then click online upgrade.

After successful operation, system pops up upgrade successful dialogue box.

File upgrade

Step 1 Select a channel and then click File upgrade.

Step 2 Select upgrade file on the pop-up interface.

Step 3 Select the upgrade file and then click OK button.

After successful operation, system pops up upgrade successful dialogue box.

Note

If there are too much remote devices, select device type from the drop-down list to search the remote device you desire.

4.2.8 Remote Device Info

4.2.8.1 Device Status

Here you can view the IPC status of the corresponding channel such as motion detect, video loss, tampering, alarm and etc. See Figure 4-49.





- IPC status: : Front-end does not support. : Front-end supports. : There is alarm event from current front-end.
- Connection status: : Connection succeeded. : Connection failed.
- Refresh: Click it to get latest front-end channel status.



Figure 4-49

4.2.8.2 Firmware

It is to view channel, IP address, manufacturer, type, system version, SN, video input, audio input, external alarm and etc. See Figure 4-50.



Figure 4-50

4.3 Preview

After device booted up, the system is in multiple-channel display mode. See Figure 4-51. Please note the displayed window amount may vary. The following figure is for reference only. Please refer to chapter 1.3 Specifications for the window-amount your product supported.







Figure 4-51

4.3.1 Preview

If you want to change system date and time, you can refer to general settings (Main Menu->Setting->System->General). If you want to modify the channel name, please refer to the display settings (Main Menu->Camera->CAM name)

Please refer to the following sheet for detailed information.

SN	Icon	Function
1		When current channel is recording, system displays this icon.

SN	Icon	Function
2		When motion detection alarm occurs, system displays this icon.
3		When video loss alarm occurs, system displays this icon.
4		When current channel is in monitor lock status, system displays this icon.

Tips

- Preview drag: If you want to change position of channel 1 and channel 2 when you are previewing, you can left click mouse in the channel 1 and then drag to channel 2, release mouse you can switch channel 1 and channel 2 positions.
- Use mouse middle button to control window split: You can use mouse middle button to switch window split amount.

4.3.2 Preview Control Interface

Move your mouse to the top center of the video of current channel, you can see system pops up the preview control interface. See Figure 4-52. If your mouse stays in this area for more than 6 seconds and has no operation, the control bar automatically hides.



Figure 4-52

1) Instant playback



It is to playback the previous 5-60 minutes record of current channel.

Please go to the Main menu->Setting->->System->General to set real-time playback time.

System may pop up a dialogue box if there is no such record in current channel.

2) Digital zoom

It is to zoom in specified zone of current channel. It supports zoom in function of multiple-channel.

Click button , the button is shown as .

There are two ways for you to zoom in.

- Drag the mouse to select a zone, you can view an interface show as Figure 4-53.



Figure 4-53

- Put the middle button at the center of the zone you want to zoom in, and move the mouse, you can view an interface shown as in Figure 4-54.



Figure 4-54

Right click mouse to cancel zoom and go back to the original interface.

3) Manual record function



It is to back up the video of current channel to the USB device. System cannot backup the video of multiple-channel at the same time.



Click button , system begins recording. Click it again, system stops recording. You can find the record file on the flash disk.

4) Manual Snapshot

Click  to snapshot 1-5 times. The snapshot file is saved on the USB device or HDD. You can go to the Search interface (chapter 4.5) to view.

5) Bidirectional talk

If the connected front-end device supports bidirectional talk function, you can click this button. Click button  to start bidirectional talk function the icon now is shown as . Now the rest bidirectional talk buttons of digital channel becomes null too.

Click  again, you can cancel bidirectional talk and the bidirectional talk buttons of other digital channels become as .

6) Registration

Shortcut menu. Click it to go to the registration interface to add/delete remote device or view its corresponding information. Please refer to chapter 4.2.2 for detailed information.

4.3.3 Right Click Menu

After you logged in the device, right click mouse, you can see the short cut menu. Please see Figure 4-55 .

- Window split mode: You can select window amount and then select channels.
- Edit view (Sequence): Change channel display sequence on the preview window.
- PTZ: Click it to go to PTZ interface.
- Auto focus: It is to set auto focus function. Please make sure the connected network camera supports this function.
- Image: Set video corresponding information.
- Search: Click it to go to Search interface to search and playback a record file.
- Record control: Enable/disable record channel.
- Camera registration: Search and add a remote device.
- Camera registration: Click to go to the Registration interface.
- Main menu: Go to system main menu interface.

Tips:

Right click mouse to go back to the previous interface.

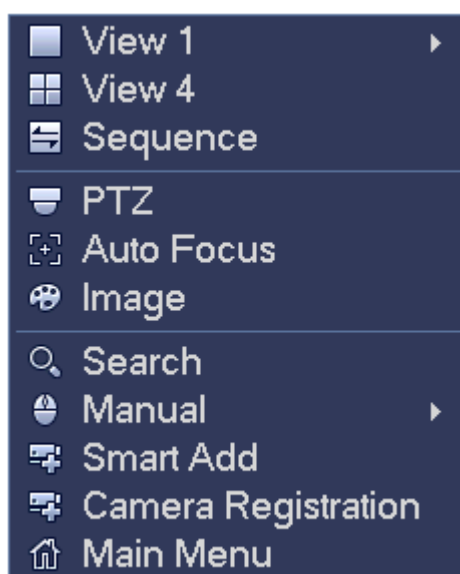

Figure 4-55

4.3.4 Edit View (Sequence)

It is to set customized view layout.







Warning

The preview layout restores default channel layout after Default operation. (Main menu->Setting->General->Default).

- Step 1 On the preview interface, right click mouse and then click Edit view. Enter edit view interface. See Figure 4-56.

 **Note**

- Enter edit view interface, device automatically switches to the max split amount mode.
- The channel list on the edit view interface displays the added camera channel number and channel name.  means camera is online.  means camera is offline.
- In case the channel amount has exceeded the device max split amount, the edit view interface can display the max screen number amount and current screen number. In Figure 4-56, click  or , switch the video from other channel.

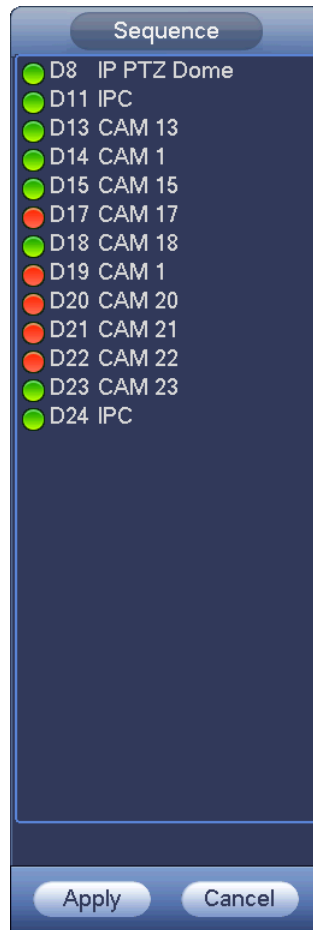

Figure 4-56

- Step 2 On the edit view interface, drag the channel to the desired window, or drag on the preview window to switch the position.
- Check the channel number at the right bottom corner to view the current channel sequence. See Figure 4-57.

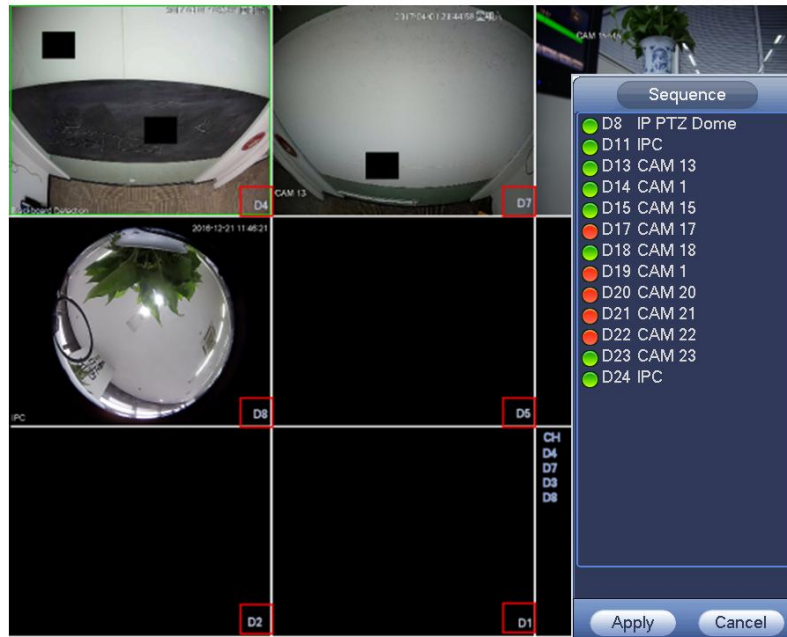

Figure 4-57

Step 3 Click Apply to save current channel sequence.

After you change the channel sequence, click Cancel button or right click mouse, device pops up the dialogue box. See Figure 4-58.

- Click OK to save current settings.
- Click Cancel to exit without saving the settings.

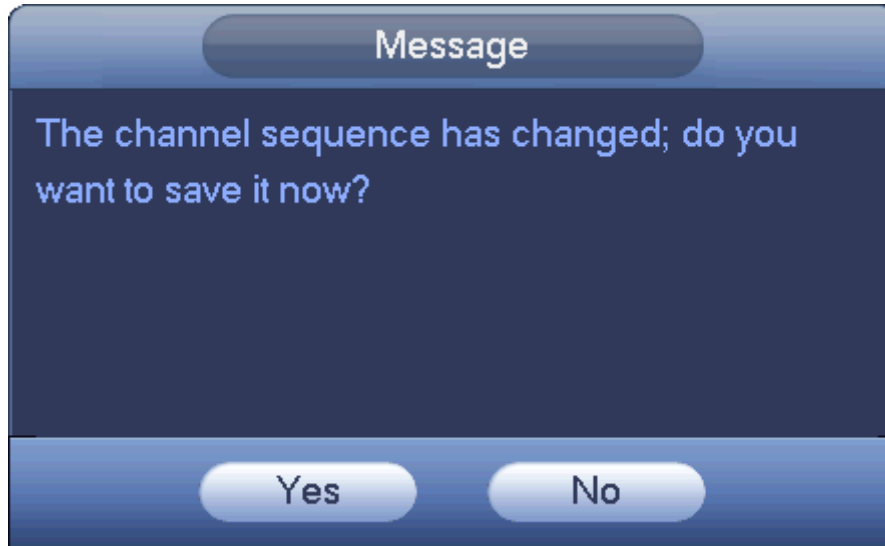

Figure 4-58

4.3.5 Preview Display Effect Setup

4.3.5.1 Display

From Main Menu->Setting->System->Display->Display, you can go to the following interface. See Figure 4-59.

Here you can set menu and video preview effect. All you operation here does not affect the record file and

playback effect.



Figure 4-59

Now you can set corresponding information.

- Resolution: There are five options: 1280×1024 (Default), 1280×720, 1920×1080, 1024×768 and 3840×2160. Please note the system needs to reboot to activate current setup. **Please note 3840×2160 is for some series only.**
- Transparency: Here is for you to adjust menu transparency. The higher the value is, the better transparent the menu is.
- Time display: You can select to display time or not when system is playback.
- Channel display: You can select to channel name or not when system is playback.
- Image enhance: Check the box; you can optimize the margin of the preview video.
- Original scale: Check the box here to select a corresponding channel; it can restore video original scale.

Click Save button to save current setup.

4.3.5.2 Preview Tour Parameters

Set preview display mode, channel display sequence and tour setup.

- Set preview display mode: On the preview interface, right click mouse, you can view right-click menu. Now you can select preview window amount and channel.
- Set channel display mode: On the preview interface, if you want to change channel 1 and channel 16

position, please right click channel 1 video window and then drag to the channel 16 video window, release button, you can change channel 1 and channel 16 position.

- Tour setup: Here you can set preview window channel display mode and interval. Please follow the steps listed below.

From Main menu->Setting->System->Display->Tour, you can see an interface shown as in Figure 4-60. Here you can set tour parameter.

- Enable tour: Check the box here to enable tour function. The general tour supports all types of window split mode.
- Interval: Input proper interval value here. The value ranges from 1-120 seconds.
- Motion tour type: System support 1/8-window tour. Please note you need to go to the main menu->Setting->Event->Video detect->Motion detect to enable tour function.
- Alarm tour type: System support 1/8-window tour. Please note you need to go to the main menu->Setting->Event->Alarm to enable tour function.
- Window split: It is to set window split mode.



Figure 4-60

4.4 PTZ

Note

Before you control the PTZ, please make sure the PTZ decoder and the NVR network connection is OK and the corresponding settings are right.

After completing all the setting please click save button. Right click mouse (click "Fn" Button in the

front panel or click “Fn” key in the remote control). The interface is shown as in Figure 4-61. Please note you can only go to the PTZ control interface when you are in 1-window display mode.

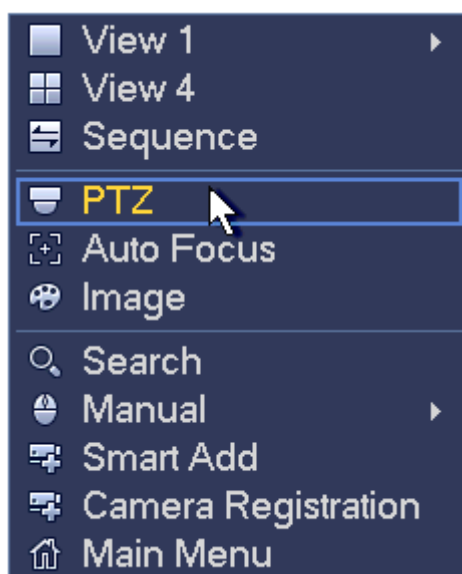

Figure 4-61



The PTZ setup is shown as in See Figure 4-62.

Please note the commend name is grey once device does not support this function.

The PTZ operation is only valid in one-window mode.

Here you can control PTZ direction, speed, zoom, focus, iris, preset, tour, scan, pattern aux function, light and wiper, rotation and etc.

Speed is to control PTZ movement speed. The value ranges from 1 to 8.The speed 8 is faster than speed 1. You can use the remote control to click the small keyboard to set.

You can click  and  of the zoom, focus and iris to zoom in/out, definition and brightness.

The PTZ rotation supports 8 directions. If you are using direction buttons on the front panel, there are only four directions: up/down/left/right.

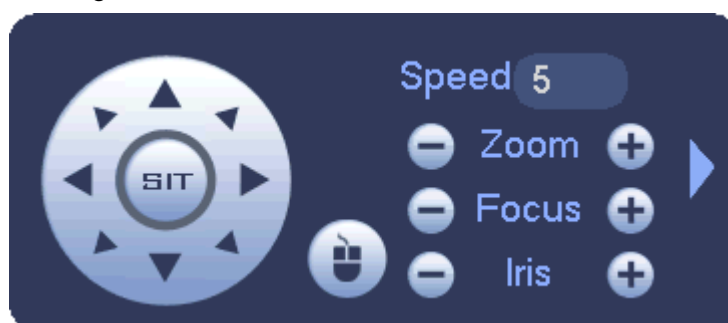

Figure 4-62

In the middle of the eight direction arrows, there is a 3D intelligent positioning key. See Figure 4-63. Please make sure your protocol supports this function and you need to use mouse to control.

Click this key, system goes back to the single screen mode. Drag the mouse in the screen to adjust section size. The dragged zone supports 4X to 16X speeds. It can realize PTZ automatically. The smaller zone you dragged, the higher the speed.



Figure 4-63

Name	Function key	function	Shortcut key	Function key	function	Shortcut key
Zoom		Near			Far	
Focus		Near			Far	
Iris		close			Open	

In Figure 4-62, click to open the menu, you can set preset, tour, pattern, scan and etc. See Figure 4-64.

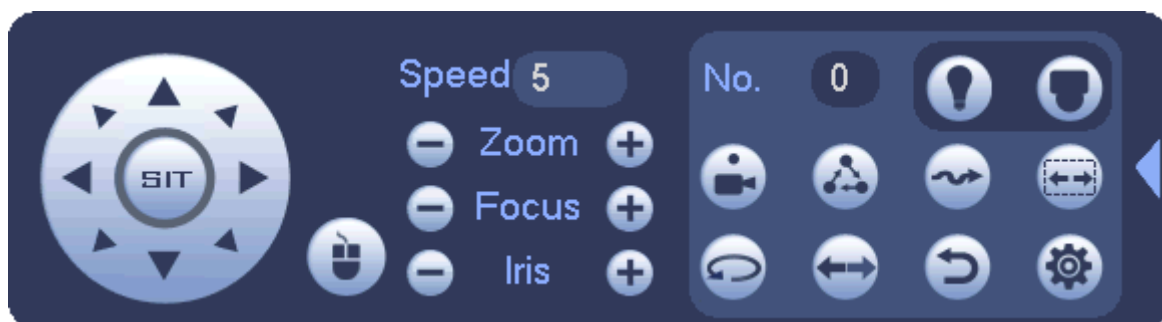

Figure 4-64

Please refer to the following sheet for detailed information.

Please note the above interface may vary due to different protocols. The button is grey and cannot be selected once the current function is null.

Right click mouse or click the ESC button at the front panel to go back to the Figure 4-62.

Icon	Function	Icon	Function
	Preset		Flip
	Tour		Reset
	Pattern		Aux
	Scan		Aux on-off button
	Rotate		Go to menu

4.4.1.1 PTZ Function Setup



Click , you can go to the following interface to set preset, tour, pattern, and scan. See Figure 4-65.



Figure 4-65

Preset Setup

In Figure 4-65, click preset button and use eight direction arrows to adjust camera to the proper position. The interface is shown as in Figure 4-66.

Click Set button and then input preset number.

Click Set button to save current preset.



Figure 4-66

Tour Setup

In Figure 4-65, click tour button.

Input tour value and preset No. Click Add preset button to add current preset to the tour. See Figure 4-67.

Tips

Repeat the above steps to add more presets to the tour. Click Del preset button to remove it from the tour.

Please note some protocols do not support delete preset function.



Figure 4-67

Pattern Setup

In Figure 4-65, click Pattern button and input pattern number.

Click Begin button to start direction operation. Or you can go back to Figure 4-62 to operate zoom/focus/iris/direction operation.

In Figure 4-65, click End button.



Figure 4-68

Scan Setup

In Figure 4-65, click Scan button.

Use direction buttons to set camera left limit and then click Left button.



Use direction buttons to set camera right limit and then click Right button. Now the scan setup process is complete.





Figure 4-69

4.4.1.2 Call PTZ Function

Call Preset

In Figure 4-64, input preset value and then click  to call a preset. Click  again to stop call.

Call Pattern

In Figure 4-64, input pattern value and then click  to call a pattern. Click  again to stop call.

Call Tour

In Figure 4-64, input tour value and then click  to call a tour. Click again  to stop call.

Call Scan

In Figure 4-64, input Scan value and then click  to call a tour. Click again  to stop call.

Rotate

In Figure 4-64, click  to enable the camera to rotate.
System supports preset, tour, pattern, scan, rotate, light and etc function.

Note:

- Preset, tour and pattern all need the value to be the control parameters. You can define it as you require.
- You need to refer to your camera user's manual for Aux definition. In some cases, it can be used for special process.

Aux

Click , system goes to the following interface. The options here are defined by the protocol. The aux number is corresponding to the aux on-off button of the decoder. See Figure 4-70.

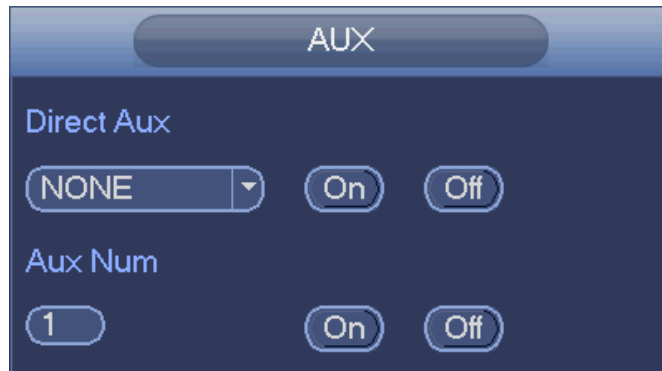

Figure 4-70

4.5 Record File

Device adopts 24-hour continuous record by default. It supports customized record period and record type. Refer to chapter 4.1.4.5 Schedule for detailed information.

4.6 Playback and Search

4.6.1 Instant Playback

Please refer to chapter 4.3.2 Preview Control Interface for real-time playback information.

4.6.2 Search Interface

From Main menu->Search, or on the preview interface right click mouse and then select search item, you can go to the following interface. See Figure 4-71.

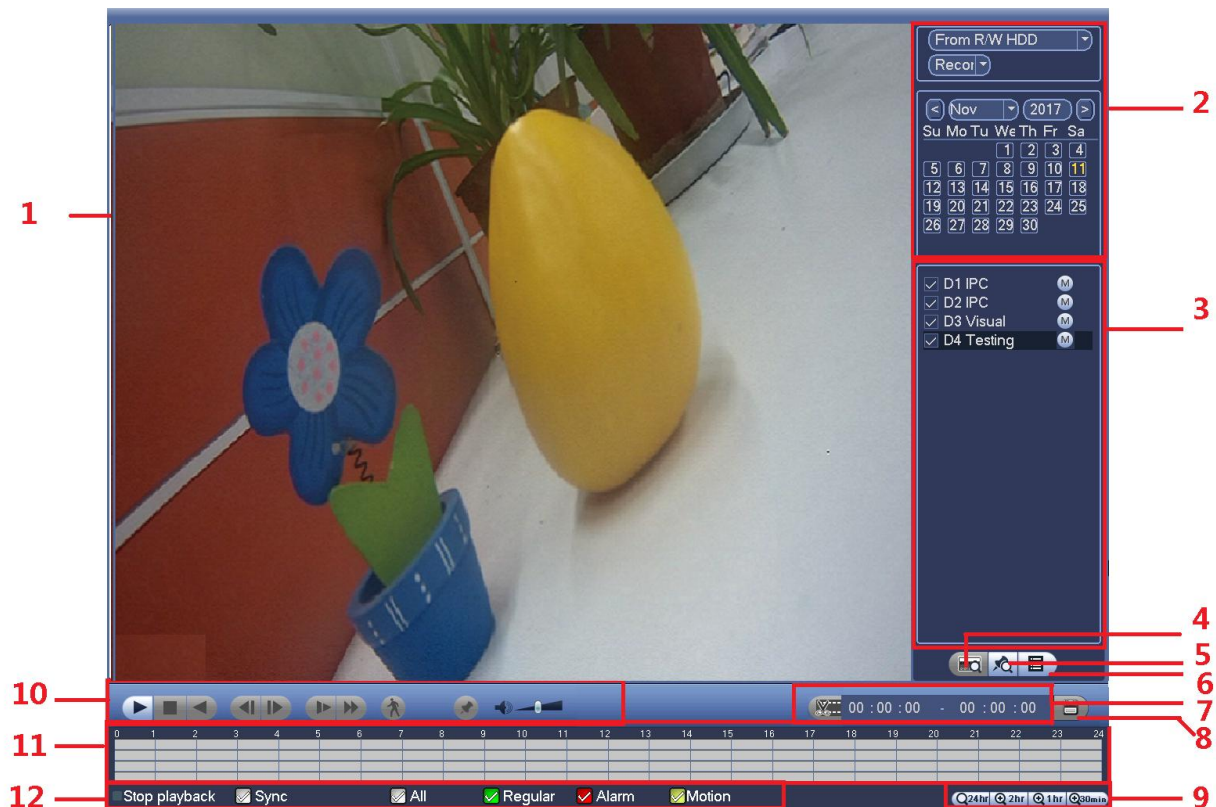



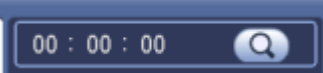







Figure 4-71

Please refer to the following sheet for more information.

SN	Name	Function
1	Display window	<ul style="list-style-type: none"> ● Here is to display the searched picture or file. ● Support 1/4/9/16-window playback. (It depends on the product channel amount).
2	Search type	<ul style="list-style-type: none"> ● Here you can select to search the picture or the recorded file. ● You can select to play from the read-write HDD, from peripheral device or from redundancy HDD. ● Before you select to play from the peripheral device, please connect the corresponding peripheral device. You can view all record files of the root directory of the peripheral device. Click the Browse button; you can select the file you want to play. <p>Important</p> <ul style="list-style-type: none"> ● Redundancy HDD does not support picture backup function, but it supports picture playback function. You can select to play from redundancy HDD if there are pictures on the redundancy HDD.
3	Display channel name and stream	Select a channel and then click  to switch main stream() and sub stream( .
4	Card number search	The card number search interface is shown as below. Here you can view card number/field setup bar. You can implement advanced search. Current series product supports this function.
5	Mark file list button	Click it to go to mark file list interface. You can view all mark information of current channel by time. Please refer to chapter 4.6.4 for detailed information. Please note only the product of this icon supports mark function.
6	File list switch button	<ul style="list-style-type: none"> ● Double click it, you can view the picture/record file list of current day. ● The file list is to display the first channel of the record file. ● The system can display max 128 files in one time. Use the ◀ and ▶ or the mouse to view the file. Select one item, and then double click the mouse or click the ENTER button to playback. ● You can input the period in the following interface to begin accurate search. ● File type:R—regular record; A—external alarm record; M—Motion detect record.  <ul style="list-style-type: none"> ● Lock file. Click the file you want to lock and click the button  to lock. The file you locked will not be overwritten. ● Search locked file: Click the button  to view the locked file.
7	Clip	Refer to chapter 4.6.2.2 Clip for detailed information.



8	Backup	<ul style="list-style-type: none"> ● Select the file(s) you want to backup from the file list. You can check from the list. Then click the backup button, now you can see the backup menu. System supports customized path setup. After select or create new folder, click the Start button to begin the backup operation. The record file(s) will be saved in the specified folder. ● Check the file again you can cancel current selection. System max supports to display 32 files from one channel. ● After you clip on record file, click Backup button you can save it. ● For one device, if there is a backup in process, you cannot start a new backup operation.
9	Time bar unit	<ul style="list-style-type: none"> ● The option includes: 、、 和 。The smaller the unit, the larger the zoom rate. You can accurately set the time in the time bar to playback the record. ● The time bar is beginning with 0 o'clock when you are setting the configuration. The time bar zooms in the period of the current playback time when you are playing the file.
10	Playback control pane.	Refer to chapter 4.6.2.1 Playback control for detailed information.
11	Time bar	<ul style="list-style-type: none"> ● It is to display the record type and its period in current search criteria. ● In 4-window playback mode, there are corresponding four time bars. In other playback mode, there is only one time bar. ● Use the mouse to click one point of the color zone in the time bar, system begins playback. ● The time bar is beginning with 0 o'clock when you are setting the configuration. The time bar zooms in the period of the current playback time when you are playing the file. ● The green color stands for the regular record file. The red color stands for the external alarm record file. The yellow stands for the motion detect record file.
12	Record type	In any play mode, the time bar will change once you modify the search type.
Other Functions		
15	Motion detection search	<ul style="list-style-type: none"> ● When system is playing, you can select a zone in the window to begin motion detection search. Click the motion detect button to begin play. ● Once the motion detect play has begun, click button again will terminate current motion detect file play. ● There is no motion detect zone by default. ● If you select to play other file in the file list, system switches to motion detect play of other file. ● During the motion detect play process, you cannot implement operations such as change time bar, begin backward playback or frame by frame playback.
16	Other channel synchroni	When playing the file, click the number button, system can switch to the same period of the corresponding channel to play.

	zation switch to play when playback	
17	Digital zoom	When the system is in full-screen playback mode, left click the mouse in the screen. Drag your mouse in the screen to select a section and then left click mouse to realize digital zoom. You can right click mouse to exit.
18	Manually switch channel when playback	During the file playback process, you can switch to other channel via the dropdown list or rolling the mouse. This function is null if there is no record file or system is in smart search process.

 **Note**

All the operations here (such as playback speed, channel, time and progress) have relationship with hardware version. Some series NVRs do not support some functions or playback speeds.











4.6.2.1 Playback Control





The playback control interface is shown as below. See Figure 4-72.



Figure 4-72

Please refer to the following sheet for more information.

Icon	Function
	Play/Pause In slow play mode, click it to switch between play/pause.
	Backward play <ul style="list-style-type: none"> In normal play mode, left click the button, the file begins backward play. Click it again to pause current play. In backward play mode, click  or  to restore normal play.
	Display previous frame/next frame. <ul style="list-style-type: none"> When pause the normal playback file, click  or  to playback frame by frame. In frame by frame playback mode, click  or  to resume normal playback mode.
	Slow play In playback mode, click it to realize various slow play modes such as slow play 1, slow play 2, and etc.
	Fast forward In playback mode, click to realize various fast play modes such as fast play 1, fast play 2 and etc.

Icon	Function
	Adjust the volume of the playback
	Smart search . You can refer to chapter 4.6.3 for detailed information.
	Click the snapshot button in the full-screen mode, the system can snapshot 1 picture. System supports custom snap picture saved path. Please connect the peripheral device first, click snap button on the full-screen mode, you can select or create path. Click Start button, the snapshot picture can be saved to the specified path.
	Mark button. Please note this function is for some series product only. Please make sure there is a mark button in the playback control pane. You can refer to chapter 4.6.4 for detailed information.

4.6.2.2 Clip

This function allows you to clip some footages to a new file and then save to the USB device. See Figure 4-73. Please follow the steps listed below.

Step 1 Select a record first and then click  to playback.

Step 2 Select a time at the time bar and then click  to start clip,

Step 3 Select a time at the time bar and then click  to stop clip,

Step 4 Click , system pops up dialogue box to save the clip file.



Figure 4-73



Note

- Clip function is for one-channel/multiple-channel.
- Max save 1024 files at the same time.
- This function is not for the file already checked in the file list.

4.6.2.3 Record Backup

This function is to backup files you checked in the file list, or the file you just clip.

Click , enter the following interface. See Figure 4-74.

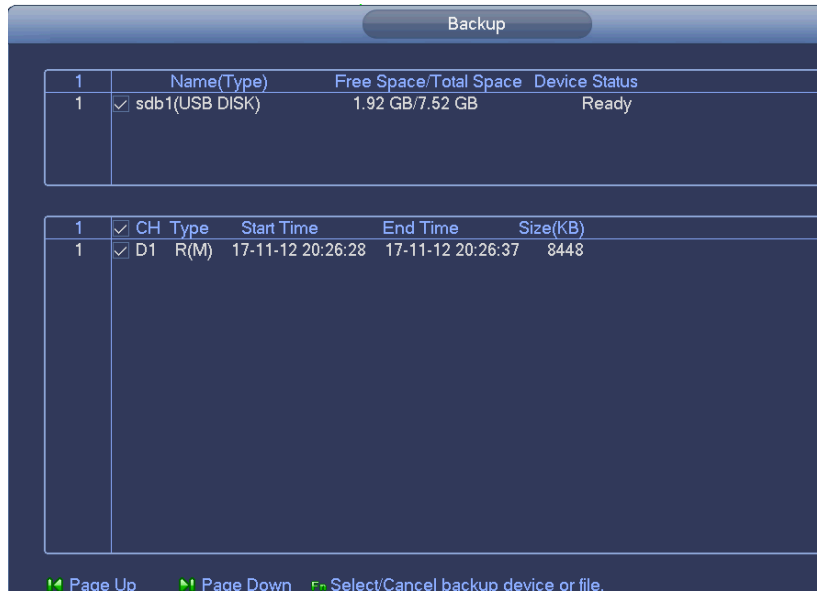

Figure 4-74

Click Backup to begin the process.

4.6.3 Smart Search Playback



Note

This function is for some series product only.

During playback process, it can analyze the motion detect zone in the scene and give the analysis result.

This function is for channel that already enabled motion detect function (main menu->Setting->Event->Video detect->Motion detect).

Please follow the steps listed below.

Step 1 Select a channel to playback video and then click . You can view the grids on the playback video.



Note

- This function is for one-channel playback mode.
- If you are in multiple-channel playback mode, double click a channel first to switch to one-channel playback mode.

Step 2 Left click mouse and then drag to select smart search zones(22*18 (PAL) , 22*15 (NTSC)).

Step 3 Click  to go to smart search and playback. System is going to playback all motion detect record footages.

Step 4 Click  again to stop smart search function.

4.6.4 Mark Playback

Please make sure your purchased device support this function. You can use this function only if you can see the mark playback icon on the Search interface (See Figure 4-71).

When you are playback record, you can mark the record when there is important information. After

playback, you can use time or the mark key words to search corresponding record and then play. It is very easy for you to get the important video information.

- Add Mark

When system is playback, click Mark button , you can go to the following interface. See Figure 4-75.

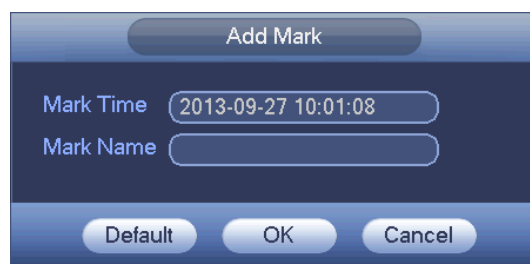



Figure 4-75

- Playback Mark

During 1-window playback mode, click mark file list button  in Figure 4-71, you can go to mark file list interface. Double click one mark file, you can begin playback from the mark time.

- Play before mark time

Here you can set to begin playback from previous N seconds of the mark time.

Note

Usually, system can playbacks previous N seconds record if there is such kind of record file. Otherwise, system playbacks from the previous X seconds when there is such as kind of record.

- Mark Manager

Click the mark manager button  on the Search interface (See Figure 4-71); you can go to Mark Manager interface. See Figure 4-76. System can manage all the record mark information of current channel by default. You can view all mark information of current channel by time.

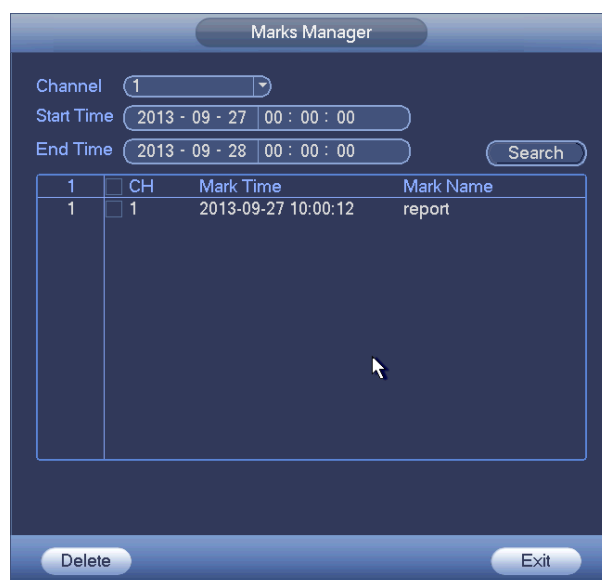

Figure 4-76

- **Modify**

Double click one mark information item, you can see system pops up a dialogue box for you to change mark information. You can only change mark name here.

- **Delete**

Here you can check the mark information item you want to delete and then click Delete button, you can remove one mark item. .



Note

- After you go to the mark management interface, system needs to pause current playback. System resume playback after you exit mark management interface.
- If the mark file you want to playback has been removed, system begins playback from the first file in the list.

4.6.5 Playback Image

Here you can search and play the image. Please follow the steps listed below.

Step 1 From main menu->Search, or on the preview window right click mouse and then click Search, you can go to the search interface.

Step 2 At the top right corner, select image and then input playback interval.

Step 3 Select date and channel, click  to play.

4.6.6 File List

Click , system displays file list. It displays the first channel of the record. See Figure 4-77.

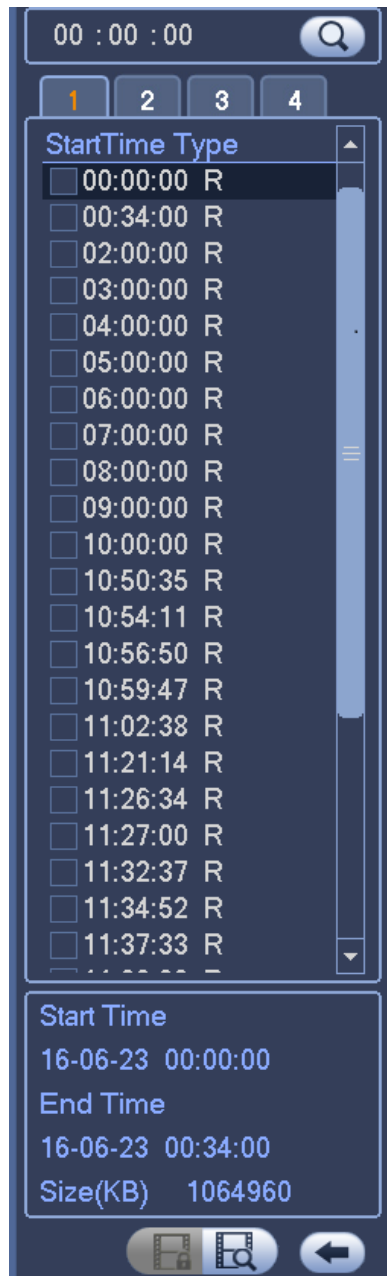



Figure 4-77

- Check a file name, double click file or click  to play.
- Input accurate time at the top column, you can search records of current day.
- System max displays 128 record files in one list.
- Click  to go back to the calendar/channel selection interface.

Lock or Unlock File

In Figure 4-77, select a file first and then click . You can lock it in case it is overwritten in the future.

Note

NVR cannot lock a file when it is writing or overwriting.

Click  you can view the locked file. See Figure 4-78.

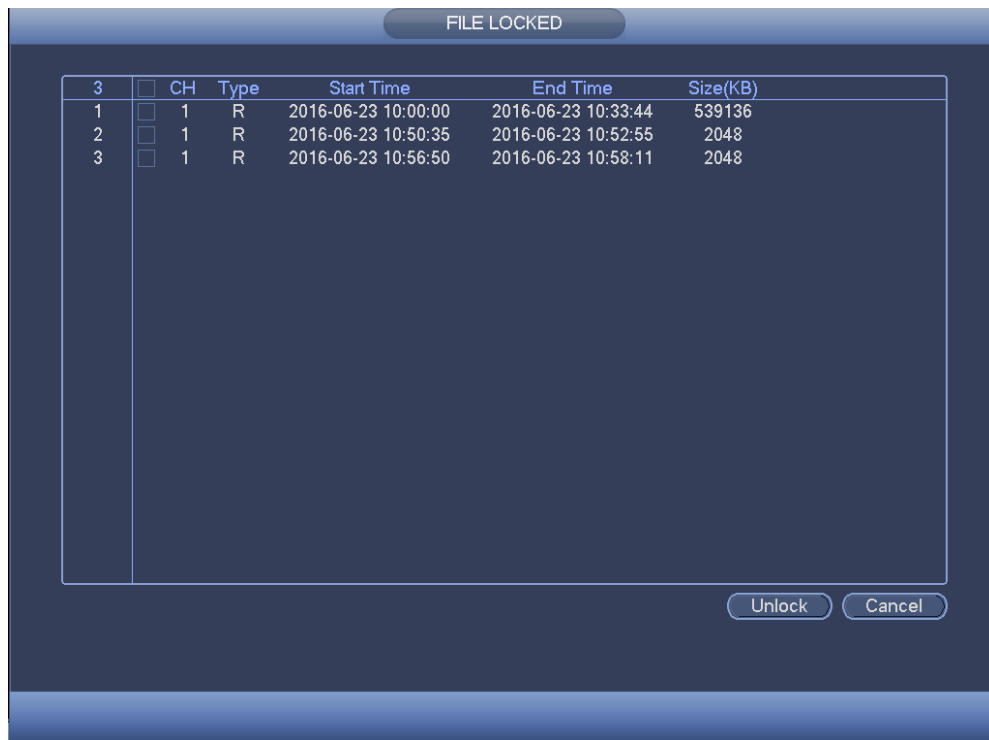

Figure 4-78

Select a file in the above figure and then click Unlock, you can unlock it.

4.6.7 Other Aux Functions

4.6.7.1 Digital Zoom

In 1-window playback mode, left click mouse to select any zone on the screen, you can zoom in current zone. Right click mouse to exit.

4.6.7.2 Switch Channel

During playback mode, select from the dropdown list to switch playback channel. This function is not for the channel of no record. The smart search channel does not support this function either.

4.7 Event Manager

4.7.1 Video Detect

The video detect adopts the computer image and graphics process technology. It can analyze the video and check there is considerable changing degree or not. Once video has changed considerably (such as there is any moving object, video is distorted), system can trigger the corresponding alarm activation operations.





In the main menu, from Setting to Detect, you can see motion detect interface. See Figure 4-79. There are four detection types: motion detection, video loss, tampering and scene changing.

4.7.1.1 Motion Detect

After analysis video, system can generate a motion detect alarm when the detected moving signal reached the sensitivity you set here.

Detection menu is shown as below. See Figure 4-79.

- Event type: From the dropdown list you can select motion detection type.
- Channel: Select a channel from the dropdown list to set motion detect function.

- Enable: Check the box here to enable motion detect function.
 - Region: Click select button, the interface is shown as in Figure 4-80. Here you can set motion detection zone. There are four zones for you to set. Please select a zone first and then left drag the mouse to select a zone. The corresponding color zone displays different detection zone. You can click Fn button to switch between the arm mode and disarm mode. In arm mode, you can click the direction buttons to move the green rectangle to set the motion detection zone. After you completed the setup, please click ENTER button to exit current setup. Do remember click save button to save current setup. If you click ESC button to exit the region setup interface system will not save your zone setup.
 - Sensitivity: System supports 6 levels. The sixth level has the highest sensitivity.
 - Anti-dither: Here you can set anti-dither time. The value ranges from 5 to 600s. The anti-dither time refers to the alarm signal lasts time. It can be seem as the alarm signal activation stays such as the buzzer, tour, PTZ activation, snapshot, channel record. The stay time here does not include the latch time. During the alarm process, the alarm signal can begin an anti-dither time if system detects the local alarm again. The screen prompt, alarm upload, email and etc will not be activated. For example, if you set the anti-dither time as 10 second, you can see the each activation may last 10s if the local alarm is activated. During the process, if system detects another local alarm signal at the fifth second, the buzzer, tour, PTZ activation, snapshot, record channel will begin another 10s while the screen prompt, alarm upload, email will not be activated again. After 10s, if system detects another alarm signal, it can generate an alarm since the anti-dither time is out.
 - Period: Click set button, you can see an interface is shown as in Figure 4-82. Here you can set motion detect period. System only enables motion detect operation in the specified periods. It is not for video loss or the tampering. There are two ways for you to set periods. Please note system only supports 6 periods in one day.
- ✧ In Figure 4-82, Select icon  of several dates, all checked items can be edited together. Now the icon is shown as . Click  to delete a record type from one period.
- ✧ In Figure 4-82. Click button  after one date or a holiday, you can see an interface shown as in Figure 4-83. There are four record types: regular, motion detection (MD), Alarm, MD & alarm.
- Latch: when motion detection complete, system auto delays detecting for a specified time. The value ranges from 1-300(Unit: second)
 - Show message: System can pop up a message to alarm you in the local host screen if you enabled this function.
 - Record channel: System auto activates motion detection channel(s) to record once an alarm occurs. Please make sure you have set MD record in Schedule interface(Main Menu->Setting->Schedule) and schedule record in manual record interface(Main Menu->Advanced->Manual Record)
 - PTZ activation: Here you can set PTZ movement when an alarm occurs. Such as go to preset, tour & pattern when there is an alarm. Click “select” button, you can see an interface is shown as in Figure 4-81.
 - Record Delay: System can delay the record for specified time after alarm ended. The value ranges from 10s to 300s.
 - Tour: Here you can enable tour function when alarm occurs. System one-window tour.
 - Snapshot: You can enable this function to snapshot image when a motion detect alarm occurs.

Please highlight icon  to select the corresponding function.

Note:

In motion detection mode, you cannot use copy/paste to set channel setup since the video in each channel may not be the same.

In Figure 4-80, you can left click mouse and then drag it to set a region for motion detection. Click Fn to switch between arm/withdraw motion detection. After setting, click enter button to exit.



Figure 4-79

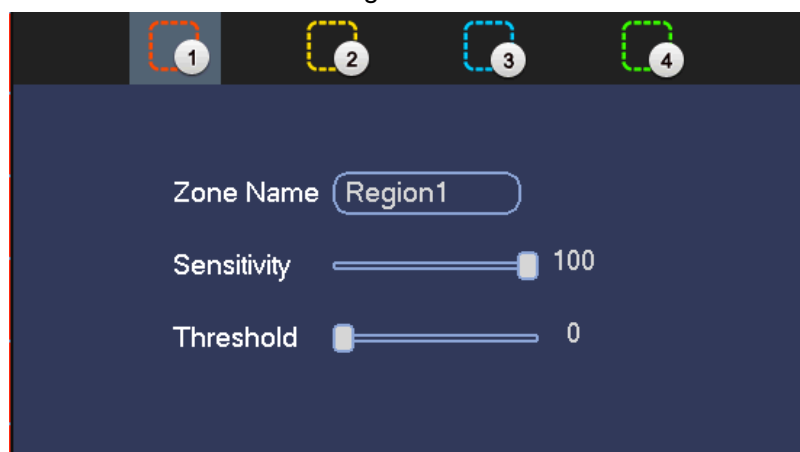

Figure 4-80



Figure 4-81

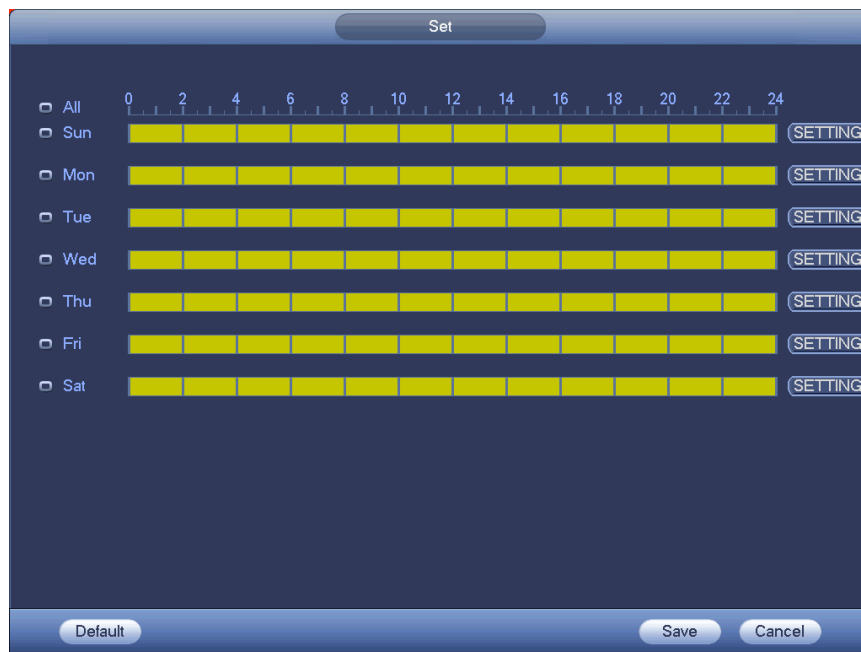

Figure 4-82



Figure 4-83

Motion detect here only has relationship with the sensitivity and region setup. It has no relationship with other setups.

4.7.1.2 Video Loss

After connected the system to the remote device, system can generate an alarm once the remote device has lost the video. System can trigger the corresponding alarm operations.

In Figure 4-79, select video loss from the type list. You can see the interface is shown as in Figure 4-84. This function allows you to be informed when video loss phenomenon occurred. You can enable alarm output channel and then enable show message function.

You can refer to chapter 4.7.1.1 Motion detect for detailed information.

Tips:

You can enable preset/tour/pattern activation operation when video loss occurs.



Figure 4-84

4.7.1.3 Tampering

When someone viciously masks the lens, or the output video is in one-color due to the environments light change, the system can alert you to guarantee video continuity. Tampering interface is shown as in Figure 4-85. You can enable “Alarm output “or “Show message” function when tampering alarm occurs.

- Sensitivity: The value ranges from 1 to 6. It mainly concerns the brightness. The level 6 has the higher sensitivity than level 1. The default setup is 3.

Tips:

You can enable preset/tour/pattern activation operation when video loss occurs.

Please refer to chapter 4.7.1.1 motion detection for detailed information.



Note

- In Detect interface, copy/paste function is only valid for the same type, which means you cannot copy a channel setup in video loss mode to tampering mode.
- About Default function. Since detection channel and detection type may not be the same, system can only restore default setup of current detect type. For example, if you click Default button at the tampering interface, you can only restore default tampering setup. It is null for other detect types.
- System only enables tampering function during the period you set here. It is null for motion detect or video loss type.



Figure 4-85

4.7.2 Alarm Settings

In the main menu, from Setting->Event->Alarm, you can see alarm setup interface.

- Alarm in: Here is for you to select channel number.

In the main menu, from Setting->Event->Alarm, you can see alarm setup interface. See Figure 4-86.

There are two alarm types. See Figure 4-86 to Figure 4-87.

- ✧ IPC external alarm: When the network camera connected peripheral device has triggered an alarm, it can upload the alarm signal to the NVR via the network transmission. The system can trigger the corresponding alarm operations.
- ✧ IPC offline alarm: When the network connection between the NVR and the network camera is off, the system can trigger the corresponding alarm operations.
- Enable: Please you need to highlight this button to enable current function.
- Type: normal open or normal close.
- Period: Click set button, you can see an interface is shown as in Figure 4-89. There are two ways for you to set periods. There are max 6 periods in one day. There are four record types: regular, motion detection (MD), Alarm, MD & alarm.

- ✧ In Figure 4-89, Select icon  of several dates, all checked items can be edited together.

Now the icon is shown as . Click  to delete a record type from one period.

- ◇ In Figure 4-89. Click button  after one date or a holiday, you can see an interface shown as in Figure 4-90. There are four record types: regular, motion detection (MD), Alarm, MD & alarm.
- PTZ activation: When an alarm occurred, system can activate the PTZ operation. The PTZ activation lasts an anti-dither period. See Figure 4-88.
- Anti-dither: Here you can set anti-dither time. The value ranges from 5 to 600s. The anti-dither time refers to the alarm signal lasts time. It can be seem as the alarm signal activation stays such as the buzzer, tour, PTZ activation, snapshot, channel record. The stay time here does not include the latch time. During the alarm process, the alarm signal can begin an anti-dither time if system detects the local alarm again. The screen prompt, alarm upload, email and etc will not be activated. For example, if you set the anti-dither time as 10 second, you can see the each activation may last 10s if the local alarm is activated. During the process, if system detects another local alarm signal at the fifth second, the buzzer, tour, PTZ activation, snapshot, record channel will begin another 10s while the screen prompt, alarm upload, email will not be activated again. After 10s, if system detects another alarm signal, it can generate an alarm since the anti-dither time is out.
- Latch: When the anti-dither time ended, the channel alarm you select in the alarm output may last the specified period. The value ranges from 1 to 300 seconds. This function is not for other alarm activation operations. The latch is still valid even you disable the alarm event function directly.
- Show message: System can pop up a message to alarm you in the local host screen if you enabled this function.
- Record channel: you can select proper channel to record alarm video (Multiple choices).
 - ◇ You need to set alarm record mode as Schedule in Record interface (Main Menu->Advanced->Record). Please note the manual record has the highest priority. System record all the time no matter there is an alarm or not if you select Manual mode.
 - ◇ Now you can go to the Schedule interface (Main Menu->Setting->Schedule) to set the record type, corresponding channel number, week and date. You can select the record type:Regular/MD/Alarm/MD&Alarm. Please note, you cannot select the MD&Alarm and MD(or Alarm) at the same time.
 - ◇ Now you can go to the Encode interface to select the alarm record and set the encode parameter (Main Menu->Setting->Encode).
 - ◇ Finally, you can set the alarm input as the local alarm and then select the record channel. The select channel begins alarm record when an alarm occurred. Please note system begins the alarm record instead of the MD record if the local alarm and MD event occurred at the same time.
- Tour: Here you can enable tour function when an alarm occurs. System supports 1/8-window tour. Please go to chapter4.3.5.1 Display for tour interval setup. Please note the tour setup here has higher priority than the tour setup you set in the Display interface. Once there two tours are both enabled, system can enable the alarm tour as you set here when an alarm occurred. If there is no alarm, system implements the tour setup in the Display interface.
- Snapshot: You can enable this function to snapshot image when an alarm occurs.

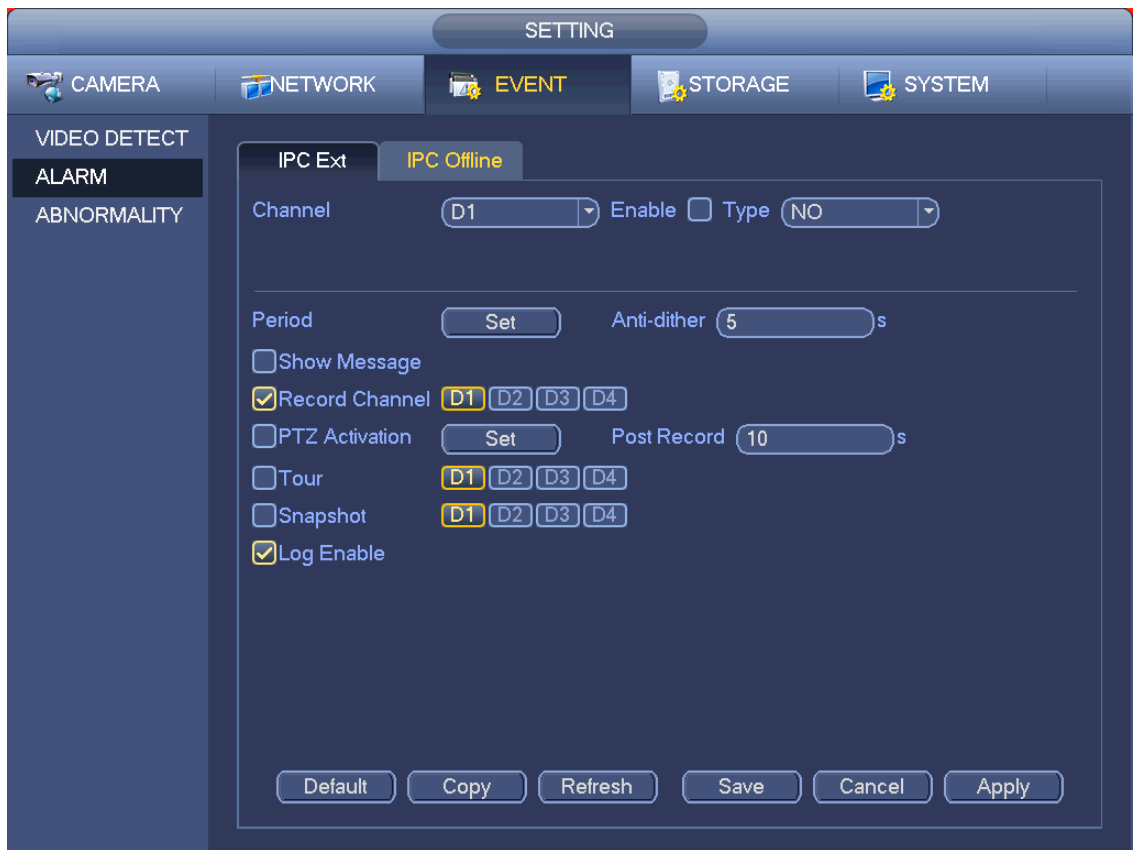

Figure 4-86



Figure 4-87



Figure 4-88

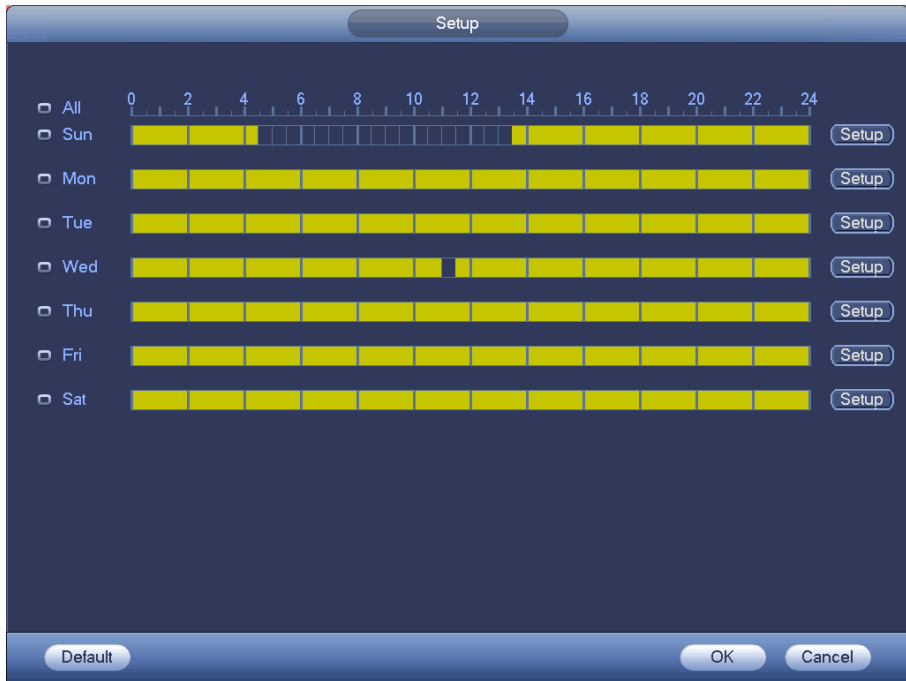



Figure 4-89



Figure 4-90

Please highlight icon  to select the corresponding function. After setting all the setups please click save button.

4.7.3 Abnormality

There are three types: HDD/Network/User.

- ✧ HDD: HDD error, no HDD, no space. See Figure 4-91.
- ✧ Network: Disconnection, IP conflict, MAC conflict. See Figure 4-92.
- ✧ User: Illegal login. Figure 4-93.
- Less than: System can alarm you when the HDD space is less than the threshold you set here (For HDD no space type only).
- Attempts: In user interface, select illegal login from the dropdown list. Here you can set login attempts. The value ranges from 1 to 10.
- Lock time: In user interface, select illegal login from the dropdown list. Here you can set account lock time. The value ranges from 1 to 30 minutes.
- Latch: Here you can set corresponding delaying time. The value ranges from 1s-300s. System automatically delays specified seconds in turning off alarm and activated output after external alarm cancelled.
- Show message: system can pop up the message in the local screen to alert you when alarm occurs.
- Send email: System can send out email to alert you when alarm occurs.
- Buzzer: Highlight the icon to enable this function. The buzzer beeps when an alarm occurs.
- Log: Check the box here, system can record corresponding alarm log.
- Voice prompts: Check the box here to trigger audio broadcast function. You can select specified audio file here. System can play the audio file once the corresponding event occurs.



Figure 4-91

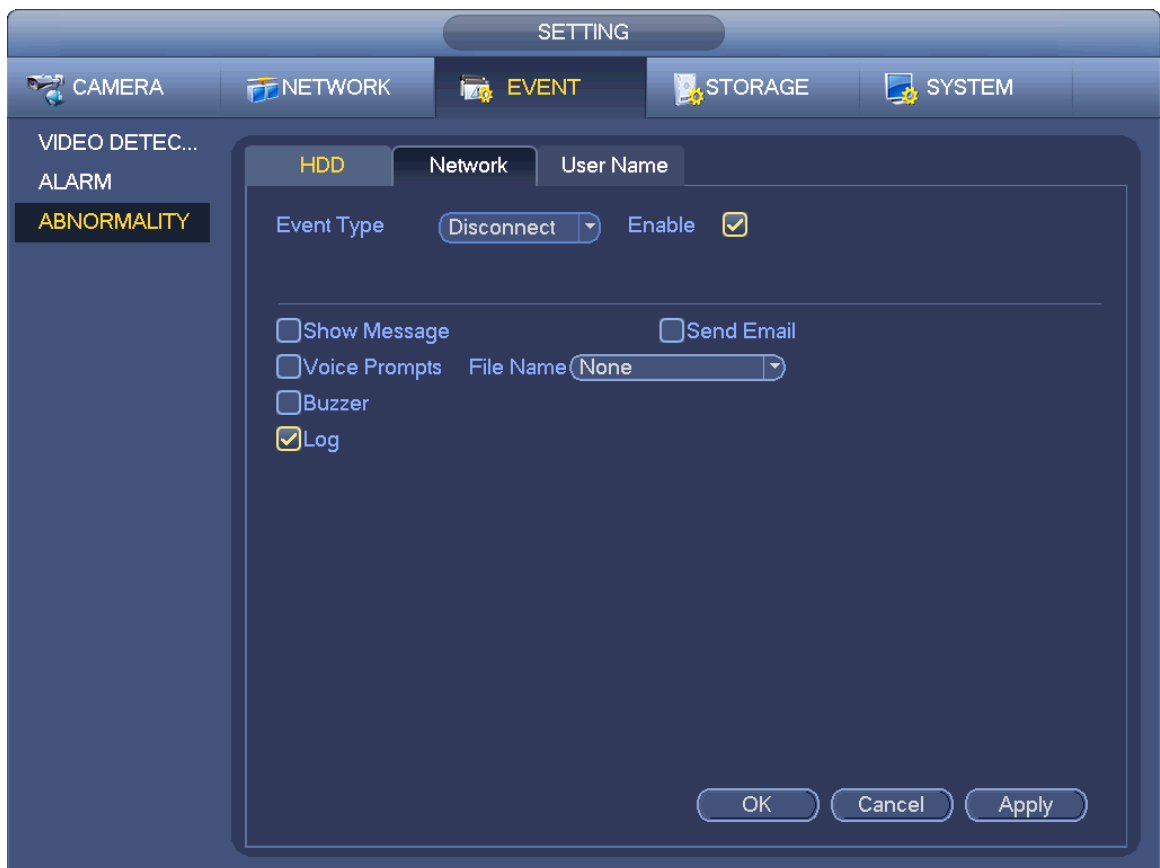

Figure 4-92



Figure 4-93

4.8 Network

4.8.1 Network Settings

4.8.1.1 TCP/IP

The interface is shown as in Figure 4-94 .

- IP Version: There are two options: IPv4 and IPv6. Right now, system supports these two IP address format and you can access via them.
- MAC address: The host in the LAN can get a unique MAC address. It is for you to access in the LAN. It is read-only.
- IP address: Here you can use up/down button (▲▼) or input the corresponding number to input IP address. Then you can set the corresponding subnet mask the default gateway.
- Default gateway: Here you can input the default gateway. Please note system needs to check the validity of all IPv6 addresses. The IP address and the default gateway shall be in the same IP section. That is to say, the specified length of the subnet prefix shall have the same string.
- Preferred DNS server: DNS server IP address.
- Alternate DNS server: DNS server alternate address.

After completing all the setups please click save button, system goes back to the previous menu.



Figure 4-94

4.8.1.2 Port

The port setup interface is shown as in Figure 4-95.

- Max connection: The max client login amount (such as WEB, platform, cellphone and etc). The value ranges from 1 to 128(default).
- TCP port: Default value is 37777.
- UDP port: Default value is 37778.
- HTTP port: Default value is 80.
- HTTPS port: Select the Enable check box and configure the port according to your actual needs. The default value is 443. After HTTPS is enabled, HTTP will be switched to HTTPS by force to transmit data in a safer way.
- RTSP port: Default value is 554.

Important: System needs to reboot after you changed and saved any setup of the above four ports. Please make sure the port values here do not conflict.



Figure 4-95

4.8.1.3 DDNS

DDNS (Dynamic Domain Name Server) is to dynamically refresh the DNS domain name and IP address if the device IP address has changed frequently. The user can use the domain to access the device.

Preparation

Before the operation, make sure the device supports DNS type and go to the DDNS service provider website to register the domain name via the PC.



Note

After you successfully registered and logged in the DDNS website, you can view all connected device information of current login user.

- Step 1 Enter from main menu > Setup > Network > DDNS.
DDNS setup interface is shown as in Figure 4-96.



Figure 4-96

Step 2 Select the Enable check box to enable DDNS function.

NOTE

After enabling DDNS, third-party server may collect your device information.

Step 3 Configure the DDNS parameters according to practical situation.

- Type/address:
 - ✧ NO-IP DDNS is dynupdate.no-ip.com.
 - ✧ CN99 DDNS is members.3322.org.
- Domain: The domain name registered on the DDNS service provider website.
- User name/password: Input the user name and password got from the DDNS service provider. Make sure you have logged in the DDNS service provider website to register an account (user name and password).
- Interval: After DDNS boots up, it sends out refresh query regularly. The unit is minute.

Step 4 Click Apply or Save to complete setup.

Step 5 Open a browser and input domain name, click Enter key.

The setting is right if you can view device WEB interface. Otherwise, please check the parameters.

4.8.1.4 Email

The email interface is shown as below. See Figure 4-97.

- SMTP server: Please input your email SMTP server IP here.
- Port: Please input corresponding port value here.
- User name: Please input the user name to login the sender email box.
- Password: Please input the corresponding password here.
- Sender: Please input sender email box here.

- Title: Please input email subject here. System support English character and Arabic number. Max 32-digit.
- Receiver: Please input receiver email address here. System max supports 3 email boxes. System automatically filters same addresses if you input one receiver repeatedly.
- SSL enable: System supports SSL encryption box.
- Interval: The send interval ranges from 0 to 3600 seconds. 0 means there is no interval.
- Health email enable: Please check the box here to enable this function. This function allows the system to send out the test email to check the connection is OK or not.
- Interval: Please check the above box to enable this function and then set the corresponding interval. System can send out the email regularly as you set here. Click the Test button, you can see the corresponding dialogue box to see the email connection is OK or not.

Please note system will not send out the email immediately when the alarm occurs. When the alarm, motion detection or the abnormality event activates the email, system sends out the email according to the interval you specified here. This function is very useful when there are too many emails activated by the abnormality events, which may result in heavy load for the email server.



Figure 4-97

4.8.1.5 Register

This function allows the device to auto register to the proxy you specified. In this way, you can use the client-end to access the NVR and etc via the proxy. Here the proxy has a switch function. In the network service, device supports the server address of IPv4 or domain.

Please follow the steps listed below to use this function.

Please set proxy server address, port, and sub-device name at the device-end. Please enable the auto

register function, the device can auto register to the proxy server.

1) The setup interface is shown as in Figure 4-98.

Important

Do not input network default port such as TCP port number.

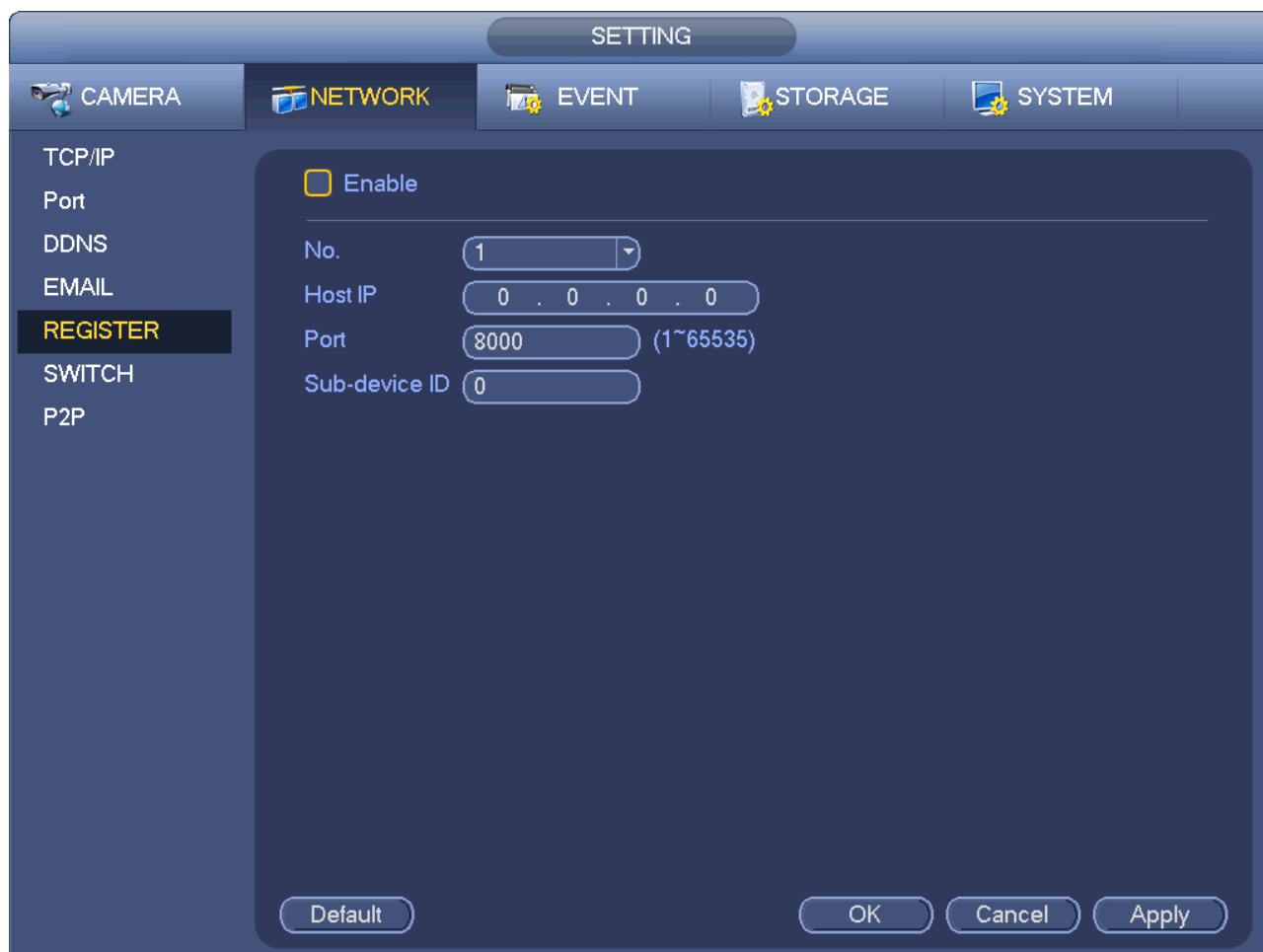

Figure 4-98

2) The proxy server software developed from the SDK. Please open the software and input the global setup. Please make sure the auto connection port here is the same as the port you set in the previous step.

3) Now you can add device. Please do not input default port number such as the TCP port in the mapping port number. The device ID here shall be the same with the ID you input in Figure 4-98. Click Add button to complete the setup.

4) Now you can boot up the proxy server. When you see the network status is Y, it means your registration is OK. You can view the proxy server when the device is online.

Important

The server IP address can also be domain. But you need to register a domain name before you run proxy device server.

4.8.1.6 P2P

You can use your cell phone to scan the QR code and add it to the cell phone client. For detailed operations, see chapter 4.1.4.3 P2P.

Via the SN from scanning the QR code, you can access the device in the WAN. Please refer to the P2P

operation manual included in the resources CD.

4.8.1.7 SWITCH

When connect a network camera to the PoE port of the NVR, NVR can automatically allocate the IP address according to the specified IP segment. The network camera can automatically register to the NVR.

It is for you to set IP address, subnet mask, gateway and etc of the Switch. See Figure 4-99.



Caution

- This function is for product of PoE port.
- Do not connect switch to the PoE port, otherwise the connection may fail.
- The SWITCH function of the NVR is enabled by default. The IP segment is 10.1.1.1. Usually we recommend the default setup.
- For the camera from the third party, make sure the camera supports ONVIF and DHCP function is enabled.



Figure 4-99

Refer to the following table for PoE notice.

Type	Note
------	------

Type	Note
Connect camera to the PoE	<p>After connect the camera to the PoE, NVR allocate an IP address in the specified IP segment to the camera. NVR tries to use arp ping to set. If the NVR has enabled the DHCP function, it uses DHCP to set.</p> <ul style="list-style-type: none"> ● After successfully set IP address, NVR can send out broadcast via the switch and get the corresponding response. Now The camera has registered to the NVR. Go to the preview interface, the corresponding channel has been used and there is a small PoE icon at the top left corner. ● Go to the Register interface to view the connected device list, you can see the PoE channel number, PoE port information and etc. Click IP search to display or refresh the information.
Remove camera from the PoE port	<p>After remove the camera network cable from the PoE port, the channel displays "Cannot find the network host". On the registration interface, the IP address is shown as offline.</p>
The mapping policy when connect a camera to the PoE port.	<p>The PoE port and the channel window is one to one correspondence. For example, connect a network camera to PoE port 1, it register to channel 1 by default.</p>

4.8.2 Network Test

In this interface, you can see network load information.

From main menu->Info-Network->Load, network load is shown as in Figure 4-100. Here you can view the follow statistics of the device network adapter.

Here you can view information of all connected network adapters. The connection status is shown as offline if connection is disconnected. Click one network adapter, you can view the flow statistics such as send rate and receive rate at the top panel.



Note

- It is to display LAN1 network load by default.
- View one LAN network load by one time.

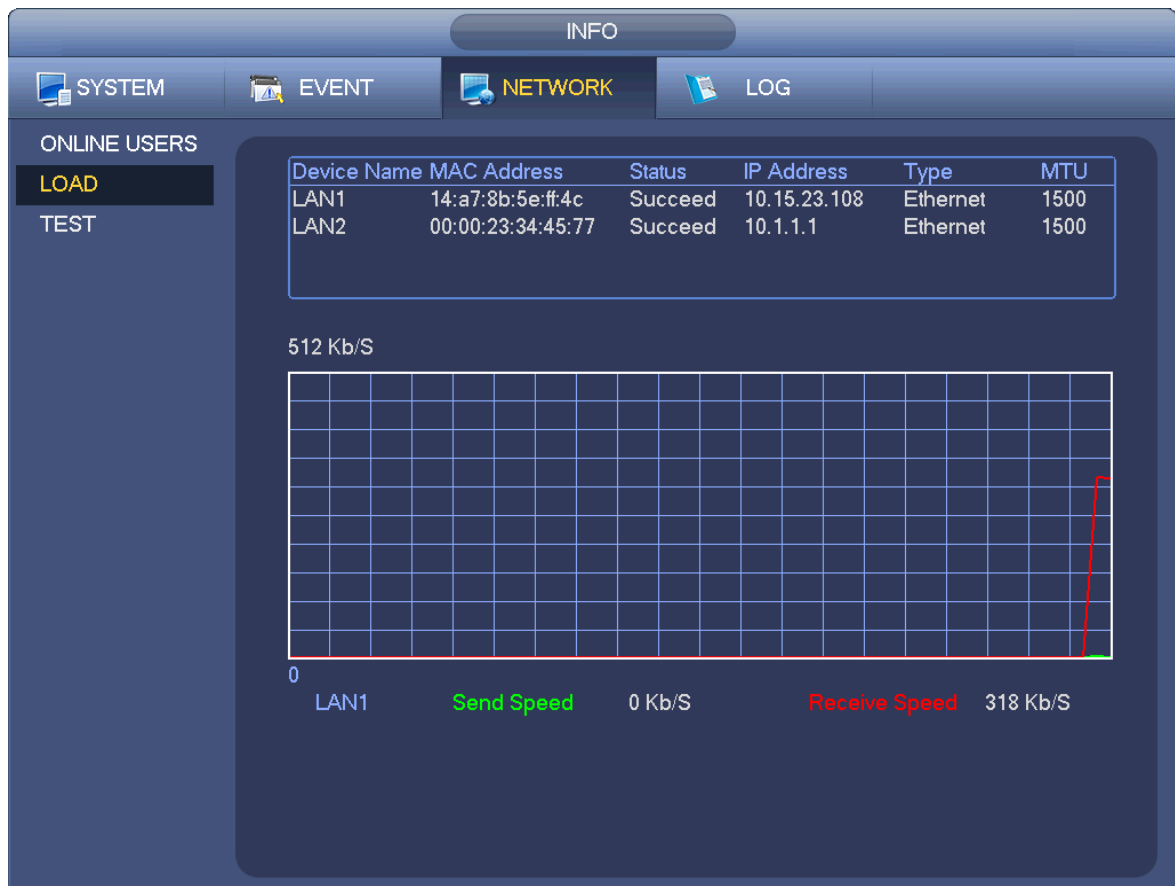

Figure 4-100

4.9 Storage

Here you can view HDD information such as type, status, total capacity, record time and etc. The operation includes format, resume from error, change HDD property (Read write, Read-only). Here you can also set alarm and HDD storage position.

4.9.1 Basic

It is to manage HDD storage space.

Step 1 From main menu->Setup->Storage->Basic.

Enter Basic interface. See Figure 4-101.

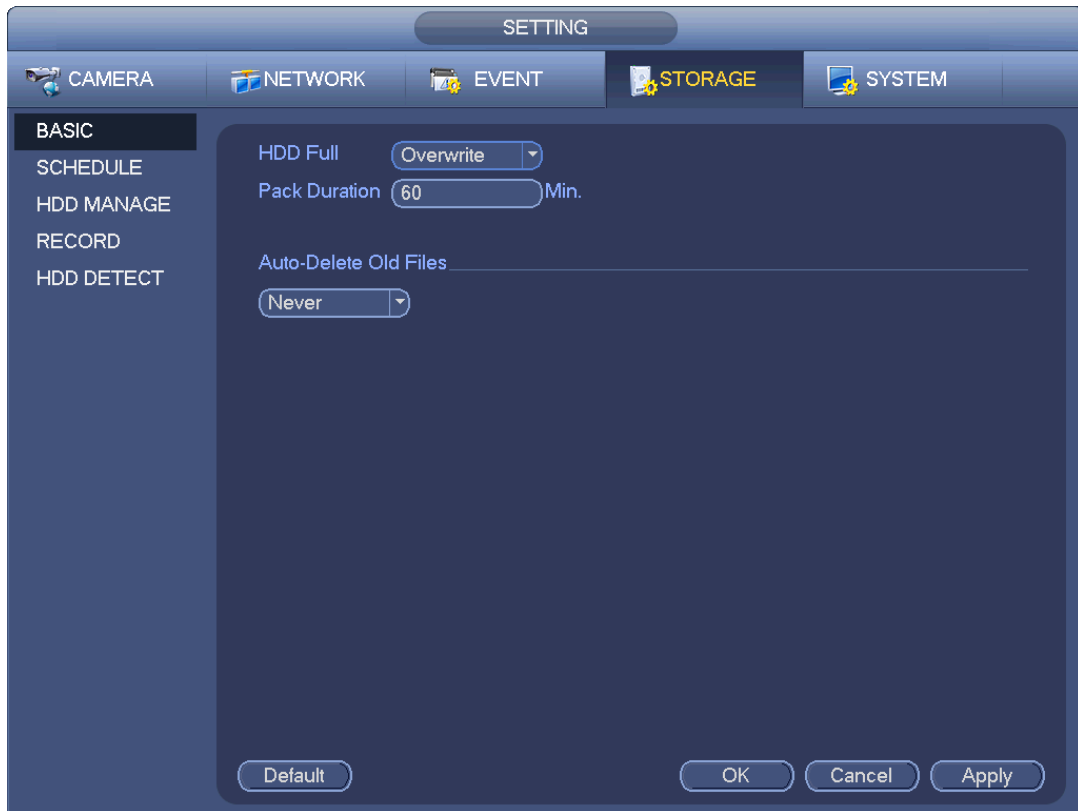

Figure 4-101

Step 2 Set parameters.

- HDD full: It is to select working mode when hard disk is full. There are two options: stop recording or rewrite.
- Pack duration: It is to specify record duration. The max length is 120 minutes.
- Auto delete old files:
 - ✧ Never: Do not auto delete old files.
 - ✧ Customized: input customized period here, system can auto delete corresponding old files.
 - ✧ The deleted file cannot be restored.

Step 3 Click Apply or Save to complete setup.

4.9.2 Schedule

It is to set schedule record and schedule snapshot. NVR can record or snapshot as you specified. For detailed information, please refer to chapter 4.1.4.5.1 schedule record and 4.1.4.5.2 schedule snapshot.

4.9.3 HDD

It is to view and sett HDD properties and format HDD.

It is to view current HDD type, status, capacity and etc. The operation includes format HDD, and change HDD property (read and write/read-only/redundancy).

- To prevent files be overwritten in the future, you can set HDD as read-only.
- To backup recorded video file, you can set HDD as redundant HDD.

Step 1 From Mani-menu->Setting->Storage->HDD Manager, you can go to HDD management interface. See Figure 4-102.

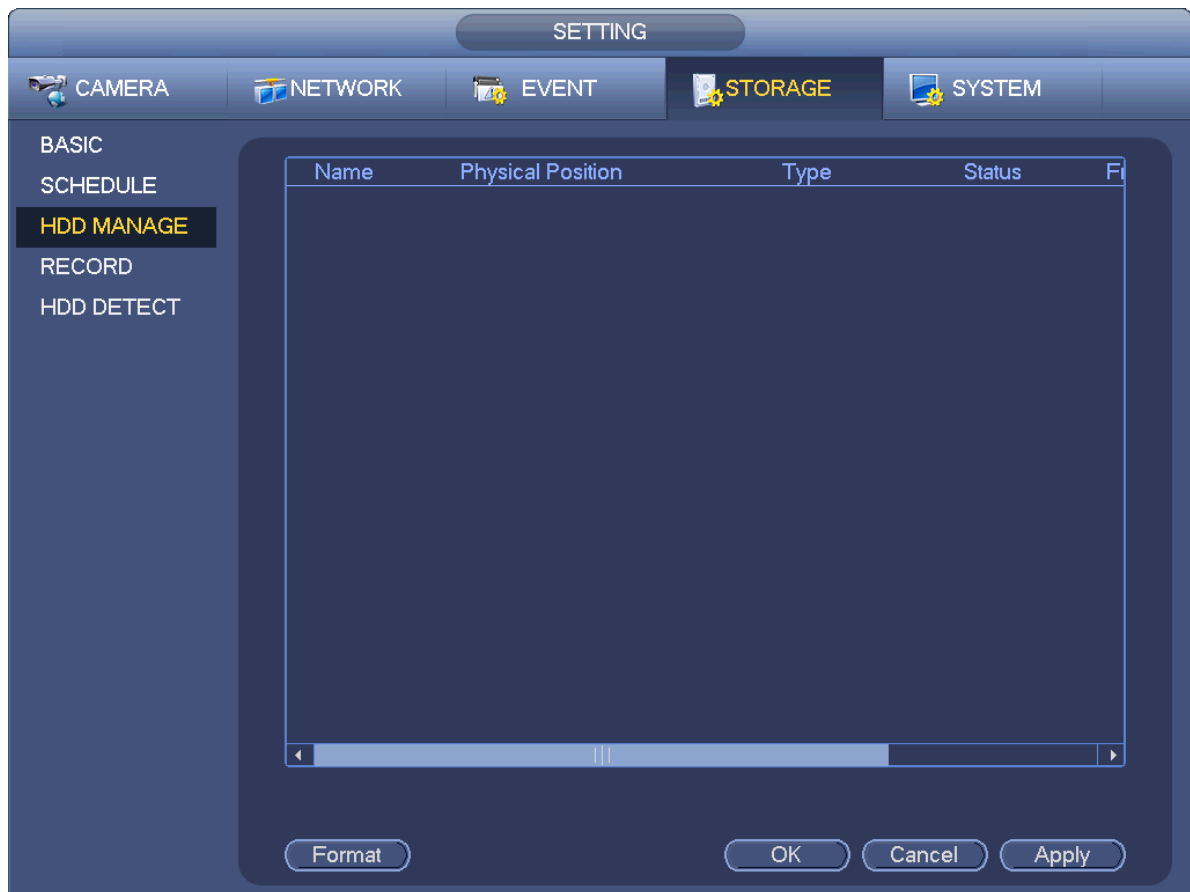

Figure 4-102

- Step 2 Select a HDD and then select an time from the dropdown list. Click Execute button.
- Step 3 Click OK button to complete the setup. You can see system needs to restart to activate current setup if you want to format the HDD.

4.9.4 Record Control

After you set schedule record or schedule snapshot function, please set auto record/snapshot function so that the NVR can automatically record or snapshot. For detailed information, please refer to chapter 4.1.4.5.3 record control.

4.9.5 HDD Information

Here is to list hard disk type, total space, free space, and status. See Figure 4-103.

- means current HDD is normal.. - means there is no HDD.

If disk is damaged, system shows as “?”. Please remove the broken hard disk before you add a new one.

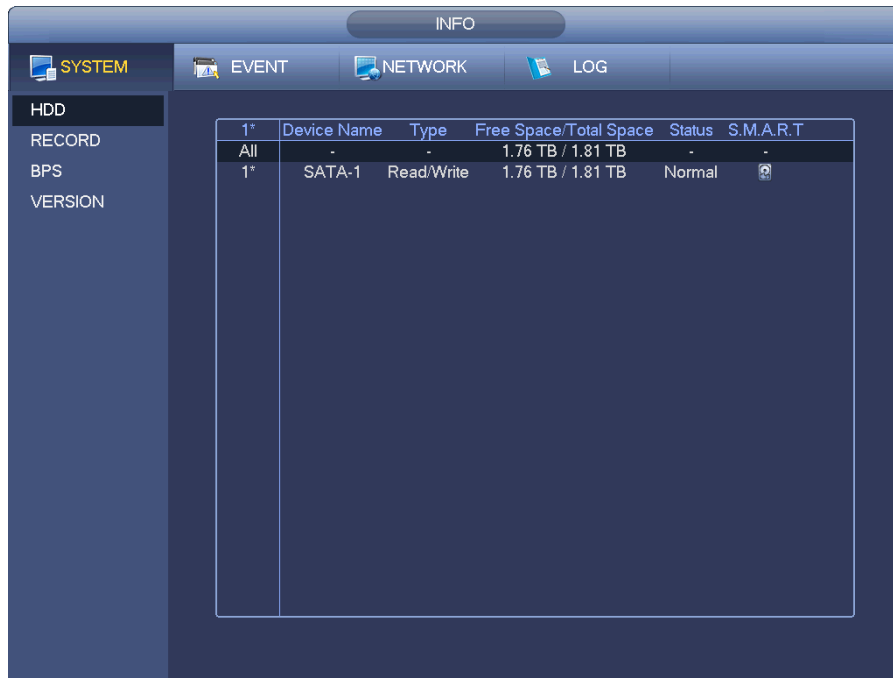

Figure 4-103

In Figure 4-103, click one HDD item, the S.M.A.R.T interface is shown as in Figure 4-104.

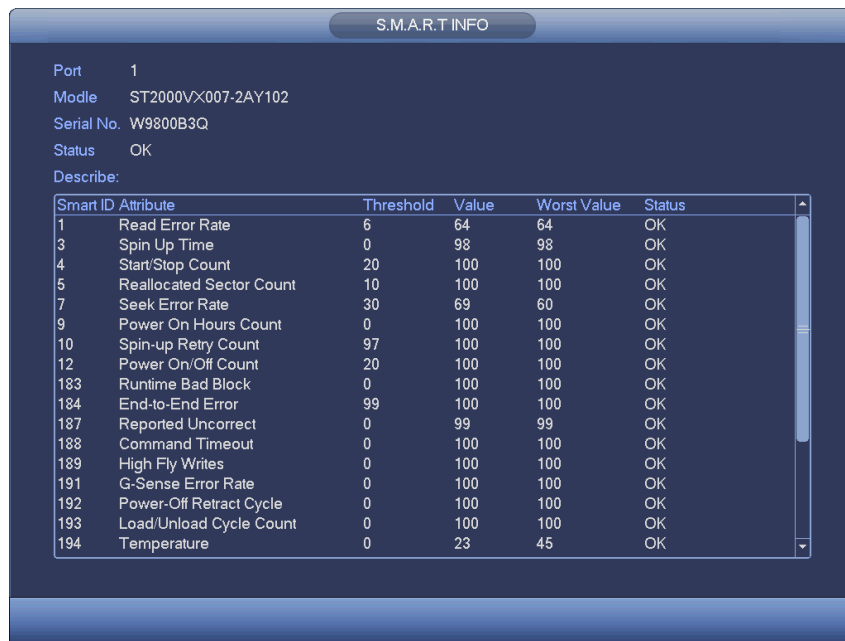

Figure 4-104

Parameter	Function
SATA	1 here means there is 1 HDD. For different series product, the max HDD amount may vary, When HDD is working properly, system is shown as O. . “_” means there is no HDD.
SN	You can view the HDD amount the device connected to;

	* means the second HDD is current working HDD.
Type	The corresponding HDD property.
Total space	The HDD total capacity.
Free space	The HDD free capacity.
Status	HDD can work properly or not.
Bad track	Display there is bad track or not.
Page up	Click it to view previous page.
Page down	Click it to view the next page.
View recording time	Click it to view HDD record information (file start time and end time).
View HDD type and capability	Click it to view HDD property, status and etc,

4.9.6 HDD Detect



Note

This function is for some series product only.

The HDD detect function is to detect HDD current status so that you can clearly understand the HDD performance and replace the malfunction HDD.

There are two detect types:

- Quick detect is to detect via the universal system files. System can quickly complete the HDD scan. If you want to use this function, please make sure the HDD is in use now. If the HDD is removed from other device, please make sure the write-data once was full after it installed on current device.
- Global detect adopts Windows mode to scan. It may take a long time and may affect the HDD that is recording.

4.9.6.1 Manual Detect

From main menu->Setting->Storage->HDD Detect->Manual Detect, the interface is shown as below. See Figure 4-105.

Please select detect type and HDD. Click start detect to begin. You can view the corresponding detect information.

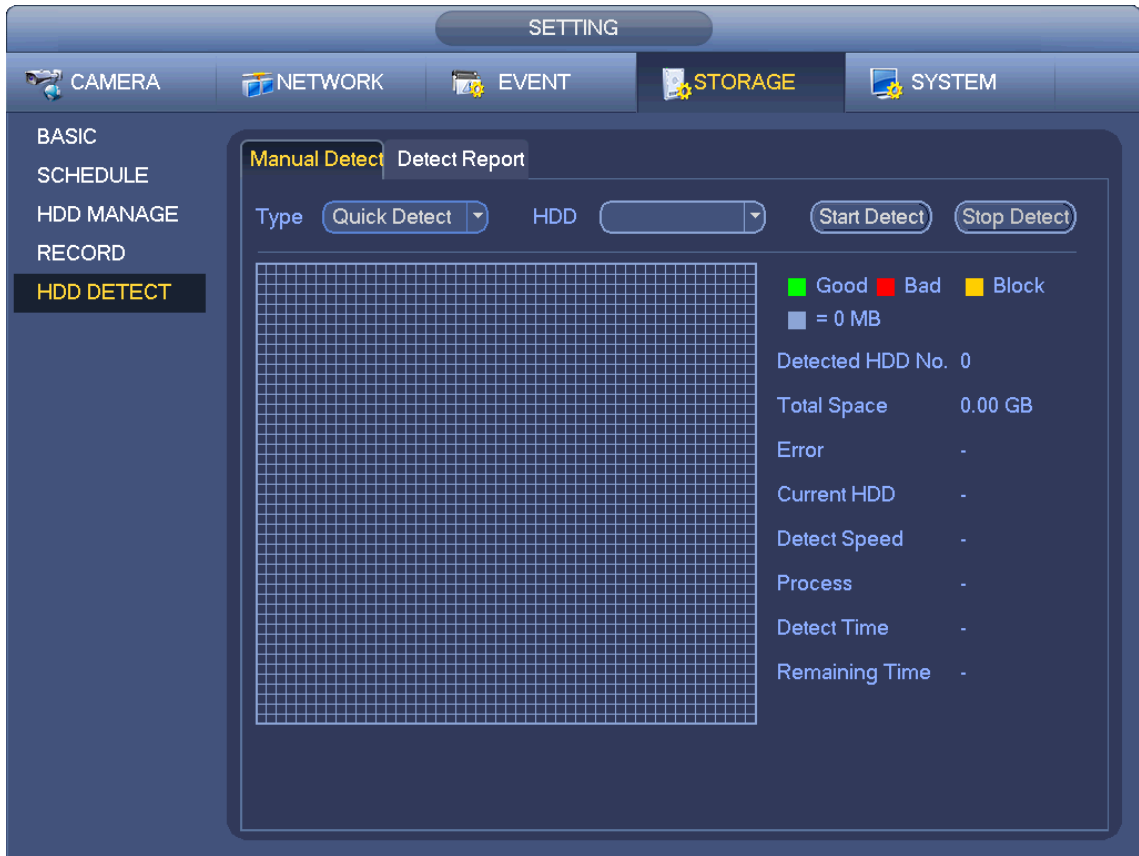

Figure 4-105

4.9.6.2 Detect Report

After the detect operation, you can go to the detect report to view corresponding information.

From main menu->Setting->Storage->HDD Detect->Manual Detect, the interface is shown as below. See Figure 4-106.

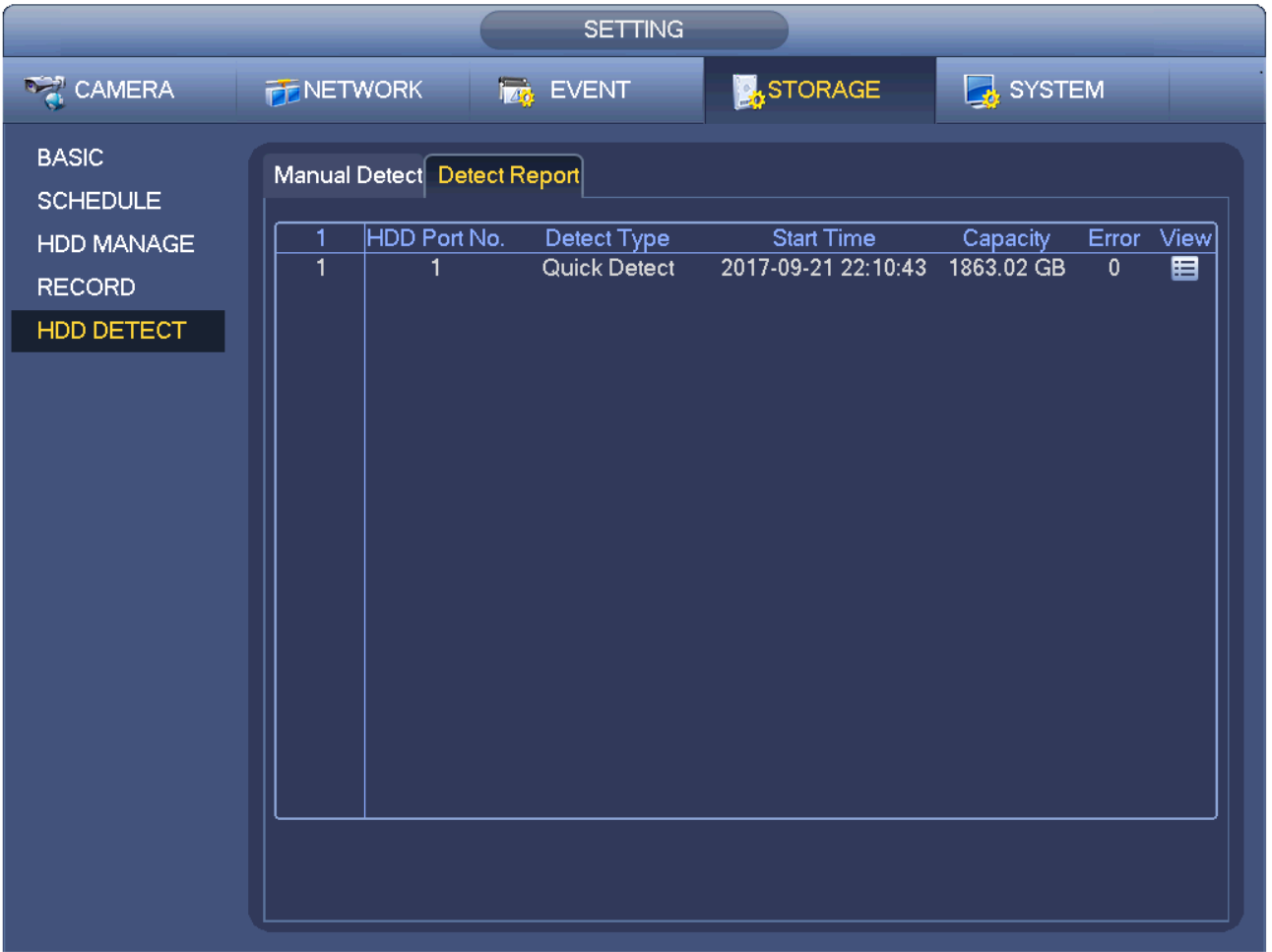

Figure 4-106

Click View, you can see the detailed information such as detect result, backup and S.M.A.R.T. See Figure 4-107 and Figure 4-108.

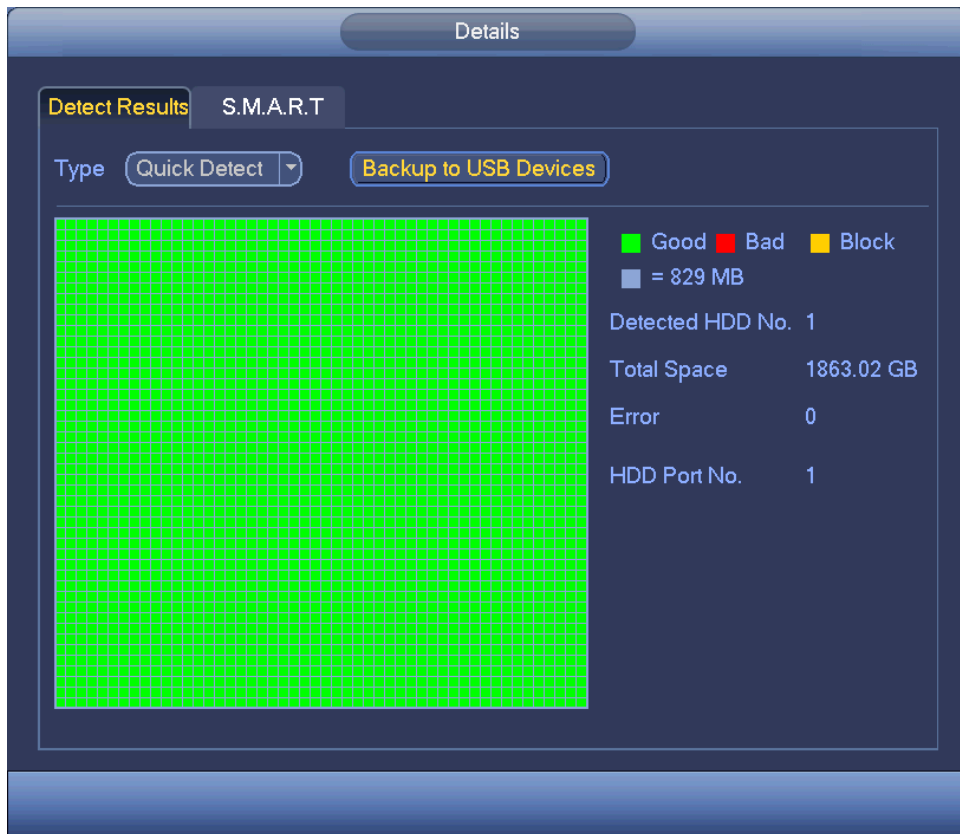

Figure 4-107



Figure 4-108

4.10 Device Maintenance and Manager

4.10.1 Account

It is to manage users, user group and ONVIF user, set admin security questions.

 **Note**

- For the user name, the string max length is 31-byte, and for the user group, the string max length is 15-byte. The user name can only contain English letters, numbers and “_”、“@”、“.”.
- The default user amount is 64 and the default group amount is 20. System account adopts two-level management: group and user. The user authorities shall be smaller than group authorities (The **admin** user authorities are set by default).
- For group or user management, there are two levels: admin and user. The user name shall be unique and one user shall only belong to one group.

4.10.1.1 User

4.10.1.1.1 Add User

Step 1 From main menu->Setting->System->Account->User.

Enter user interface. See Figure 4-109.

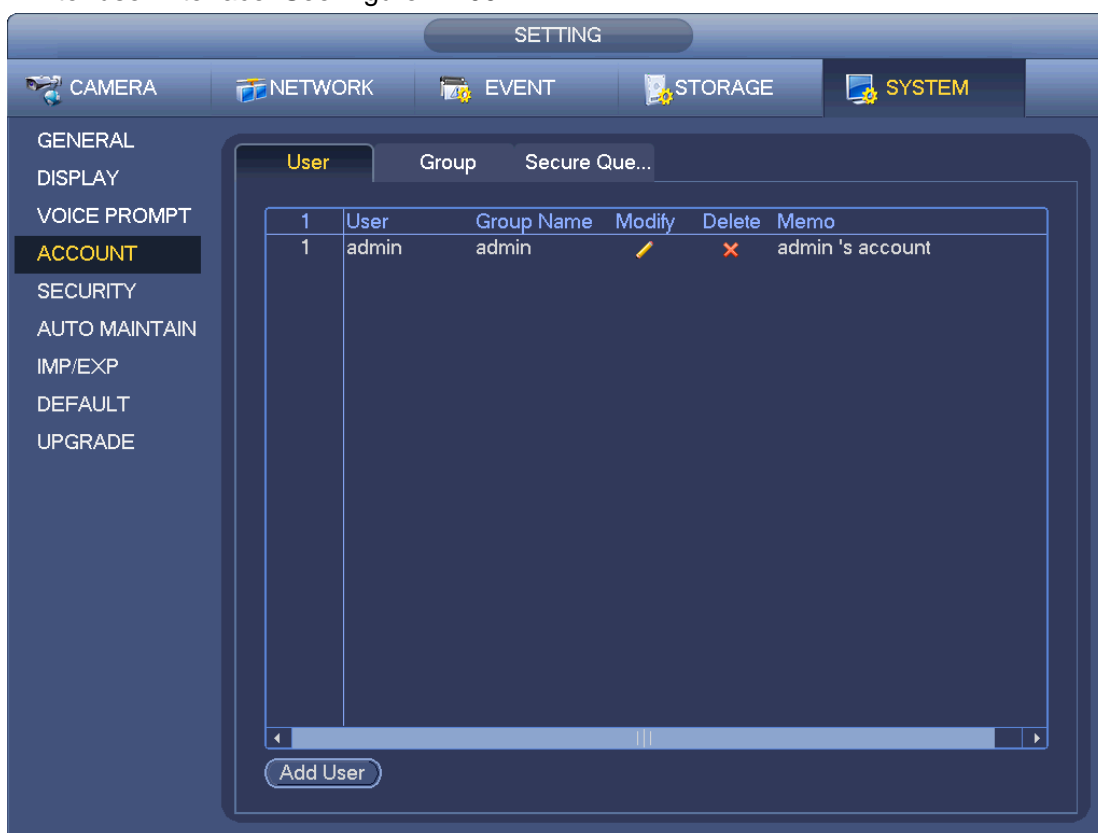

Figure 4-109

Step 2 Click Add user button in Figure 4-109.

The interface is shown as in Figure 4-110.



Figure 4-110

Step 3 Input the user name, password, select the group it belongs to from the dropdown list. Then you can check the corresponding rights for current user.



Note

For convenient user management, usually we recommend the general user right is lower than the admin account.

Step 4 Click Save button.

4.10.1.1.2 Modify user

From main menu->Setting->System->Account->User, click , you can go to the following interface to change user information. See Figure 4-111.



Figure 4-111

For **admin** user, you can change the email, enable/disable unlock pattern, change password prompt question, set security questions. See Figure 4-112.



Figure 4-112

- Input email information and then click Save, it is to set/change email address.
- Check the box to enable unlock pattern and then click , click Save to change unlock pattern.
- Set security question

Step 1 Click Security question, enter the following interface. See Figure 4-113.



Figure 4-113

Step 2 Input answers and then click Save button.

After successfully set security questions, you can answer the security questions to reset admin password.

 **Note**

Select security questions from the dropdown list and then input the proper answers, click Delete button to reset security questions and answers again.

4.10.1.1.3 Change Password

In Figure 4-111, check the Modify password box, you can change password. Please input old password, and then input new password twice to confirm.

- Password/confirm password: The password ranges from 8 to 32 digitals. It can contain letters, numbers and special characters (excluding “”, “'”, “;”, “:”, “&”). The password shall contain at least two categories. Usually we recommend the strong password.



WARNING

STRONG PASSWORD RECOMMENDED-For your device own safety, please create a strong password of your own choosing. We also recommend you change your password periodically especially in the high security system.

4.10.1.2 Modify Group

Step 1 From main menu->Setting->System->Account->Group.
Enter add group interface. See Figure 4-114.



Figure 4-114

Step 2 Click add group button in Figure 4-114.

Enter Add group the interface. See Figure 4-115.

Step 3 Input group name and then input some memo information if necessary. Check the box to select authorities.



Figure 4-115

4.10.1.3 Security Question

 **Note**

This function is for **admin** user only.

Here you can change security questions. After you successfully answered security questions, you can reset admin account password.

From main menu->Setting->System->Account->Security question, the interface is shown as below. See Figure 4-116. Input correct security answers and then click Delete button at the bottom of the interface, you can reset security questions and answers.

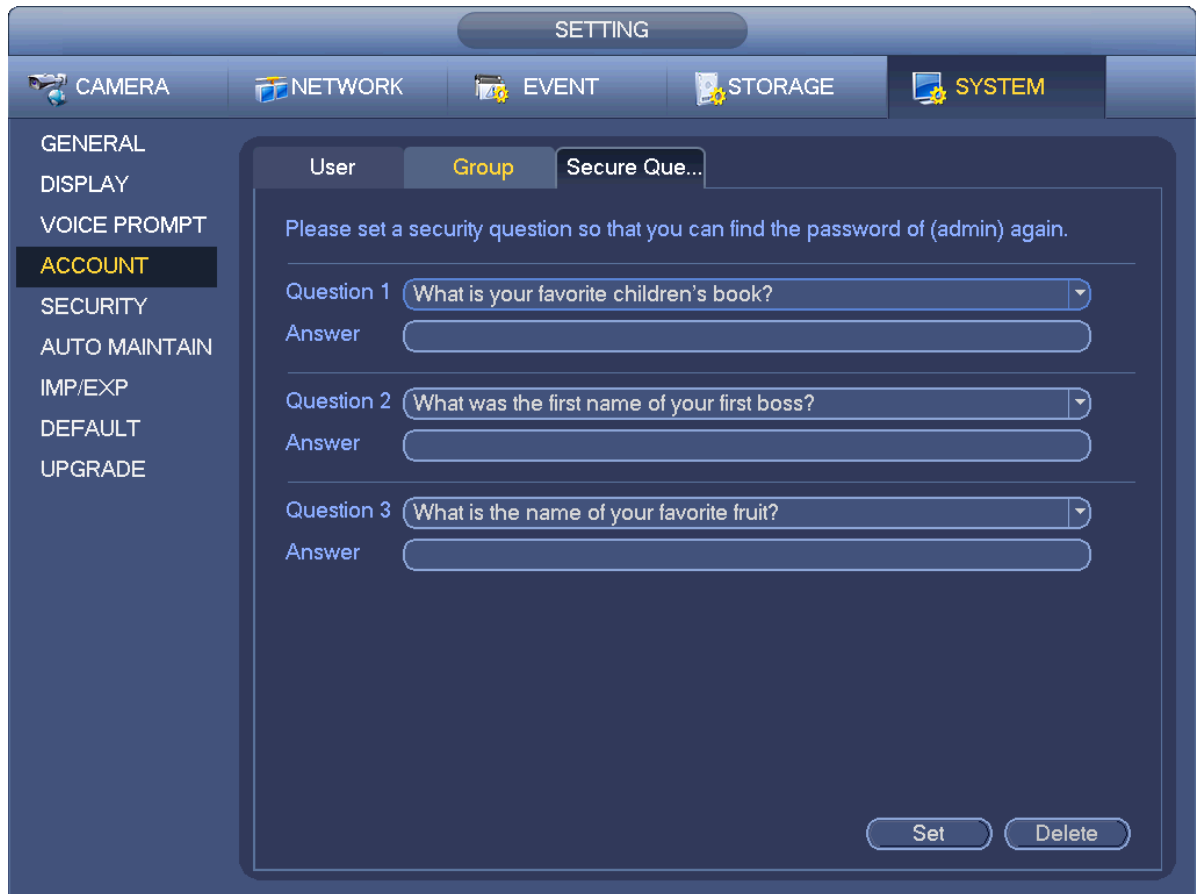

Figure 4-116

4.10.1.4 Online User

Here is for you manage online users connected to your NVR. See Figure 4-117.

You can click button  to disconnect or block one user if you have proper system right.

System detects there is any newly added or deleted user in each five seconds and refresh the list automatically.

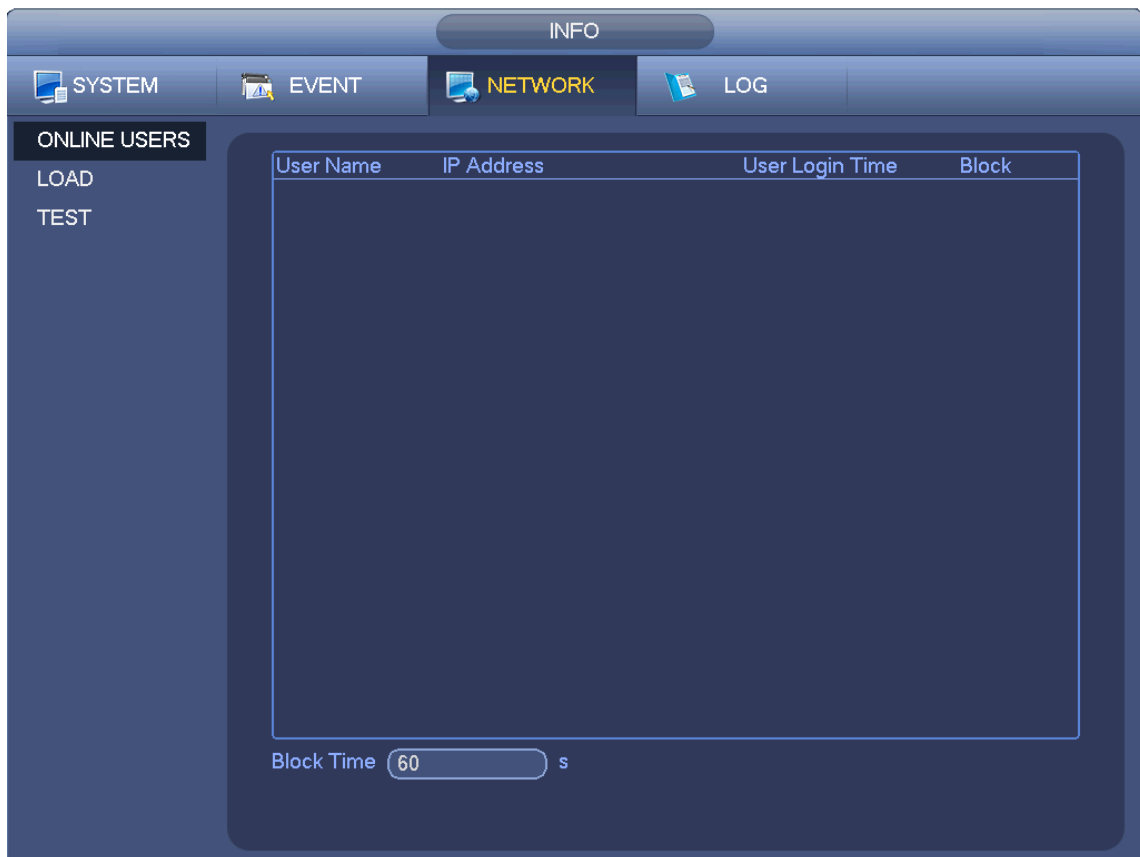

Figure 4-117

4.10.2 System Info

4.10.2.1 Version

From main menu->Info->System->version, you can go to version interface.

It is to view NVR version information. Slight different may be found on the user interface.

4.10.2.2 BPS

Here is for you to view current video bit rate (kb/s) and resolution. See Figure 4-118.



Figure 4-118

4.10.2.3 Event Information

4.10.2.3.1 Alarm Status

From main menu->info-Event, here you can view the channel status of the remote device, connection log and etc. See Figure 4-119.



Figure 4-119

4.10.3 Security

4.10.3.1 IP Filter

IP filter interface is shown as in Figure 4-120. You can add IP in the following list. The list supports max 64 IP addresses. System supports valid address of IPv4 and IPv6. **Please note system needs to check the validity of all IPv6 addresses and implement optimization.**

After you enabled trusted sites function, only the IP listed below can access current NVR.

If you enable blocked sites function, the following listed IP addresses cannot access current NVR.

- **Enable:** Highlight the box here, you can check the trusted site function and blocked sites function. You cannot see these two modes if the Enable button is grey.
- **Type:** You can select trusted site and blacklist from the dropdown list. You can view the IP address on the following column.
- **Start address/end address:** Select one type from the dropdown list, you can input IP address in the start address and end address. Now you can click Add IP address or Add IP section to add.
 - a) For the newly added IP address, it is in enable status by default. Remove the before the item, and then current item is not in the list.
 - b) System max supports 64 items.
 - c) Address column supports IPv4 or IPv6 format. If it is IPv6 address, system can optimize it. For example, system can optimize aa:0000: 00: 00aa: 00aa: 00aa: 00aa as aa:: aa: aa: aa: aa: aa: aa.
 - d) System automatically removes space if there is any space before or after the newly added IP address.
 - e) System only checks start address if you add IP address. System check start address and end address if you add IP section and the end address shall be larger than the start address.
 - f) System may check newly added IP address exists or not. System does not add if input IP address does not exist.
- **Delete:** Click it to remove specified item.
- **Edit:** Click it to edit start address and end address. See Figure 4-121. System can check the IP address validity after the edit operation and implement IPv6 optimization.
- **Default:** Click it to restore default setup. In this case, the trusted sites and blocked sites are both null.



Note

- If you enabled trusted sites, only the IP in the trusted sites list can access the device.
- If you enabled blocked sites, the IP in the blocked sites cannot access the device.
- System supports add MAC address.

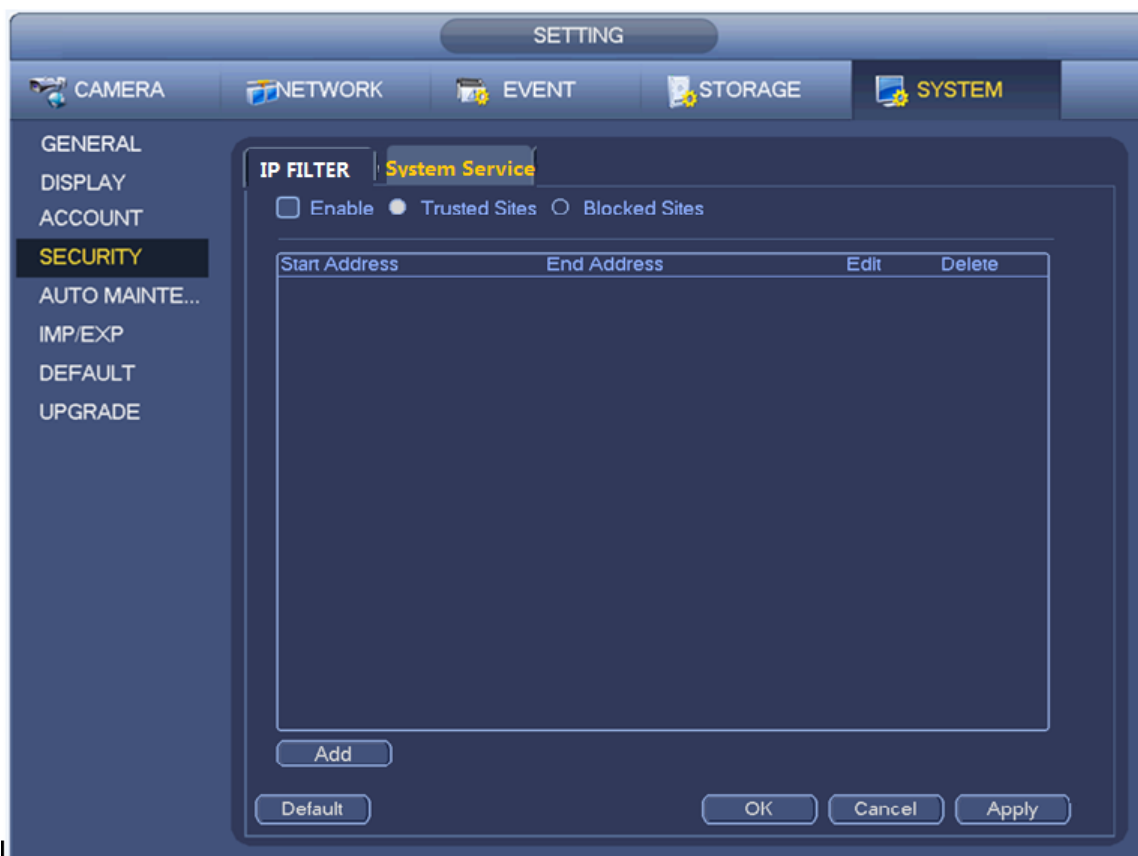

Figure 4-120

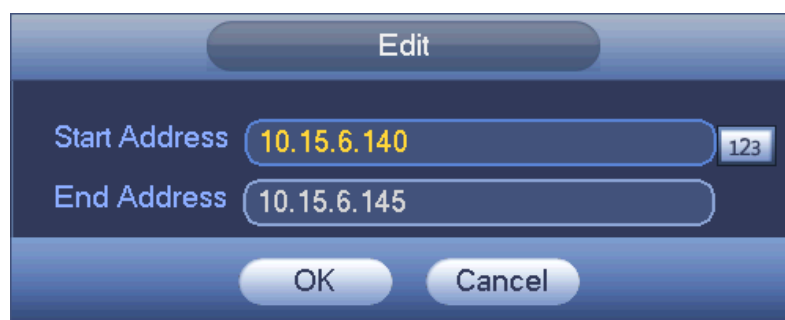

Figure 4-121

4.10.3.2 System Service

The device supports to enable and disable various system internal services.

Step 1 From main menu->System->Security ->System Service.

The System Service interface is displayed. See Figure 4-122.

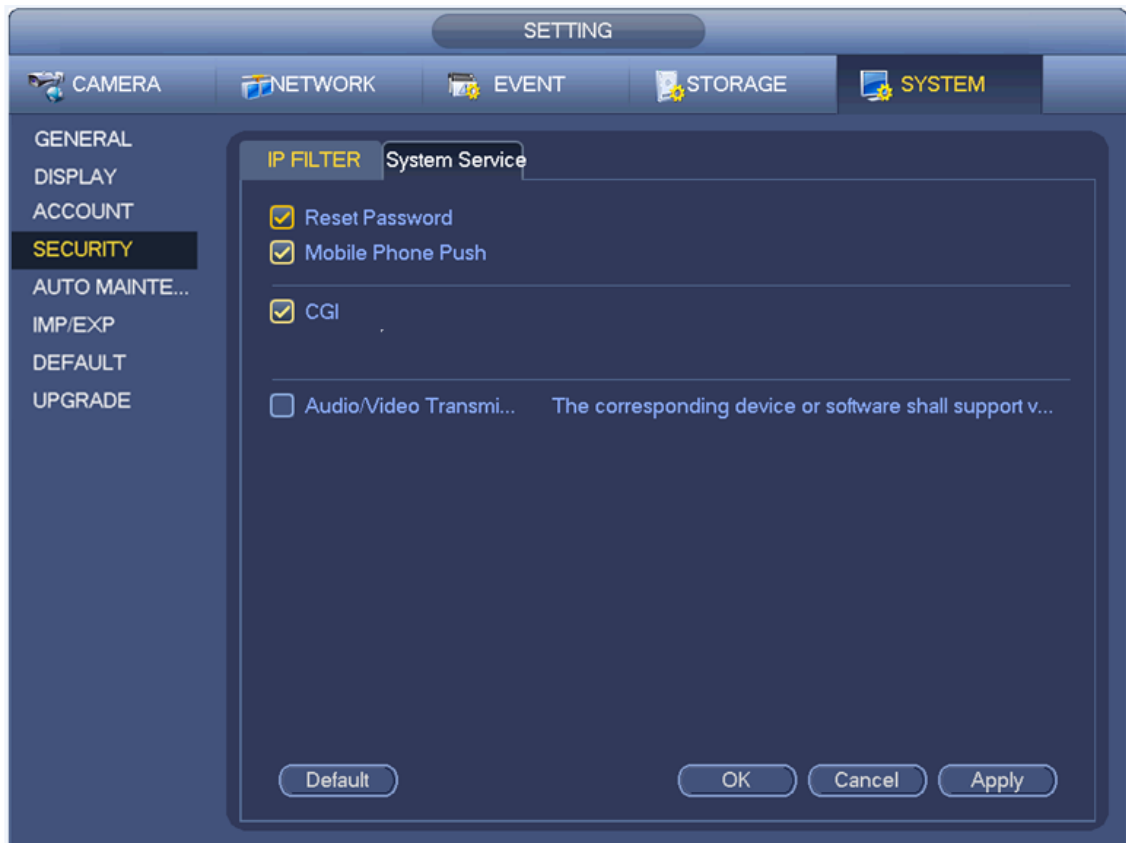

Figure 4-122

Step 2 Configure the parameters. For details, see the below table.

Parameter	Description
Password Reset	Enabled by default. If it is disabled, the user can only use the security questions to reset the password.
Mobile Phone Push	Enabled by default. The snapped pictures triggered at the device can be push to the mobile app.
CGI	Enabled by default. The device can be connected via this protocol when enabled.
Audio/VideoEncryption	The stream transmission is encrypted when this function is enabled. The associated device or software shall support decryption.

Step 3 Click OK to complete the configuration.

4.10.4 Auto Maintain

Here you can set auto-reboot time and auto-delete old files setup. You can set to delete the files for the specified days. See Figure 4-123.

You can select proper setup from dropdown list.

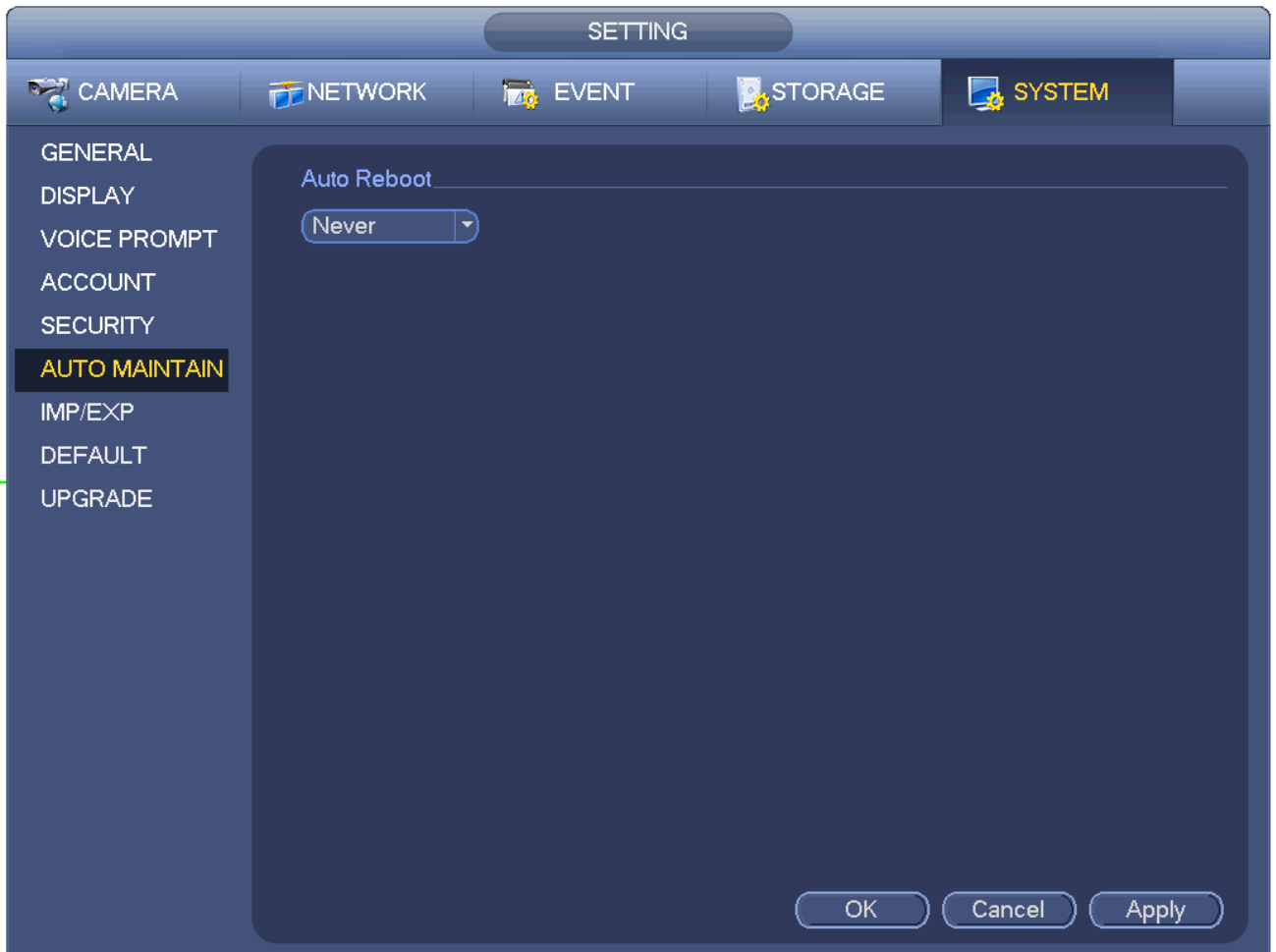

Figure 4-123

4.10.5 Backup

4.10.5.1 File Backup

In this interface, you can backup record file to the USB device.

- a) Connect USB burner, USB device or portable HDD and etc to the device.
- b) From Main menu->Backup, you can go to the Backup interface. See Figure 4-124

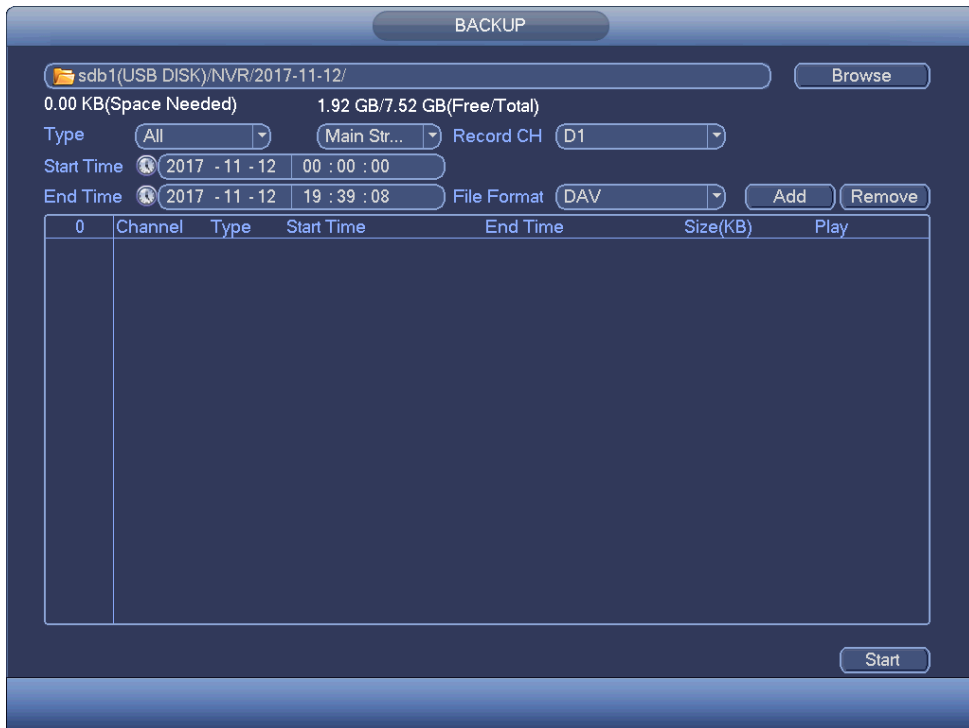

Figure 4-124

- c) Select backup device and then set channel, file start time and end time.
- d) Click add button, system begins search. All matched files are listed below. System automatically calculates the capacity needed and remained. See Figure 4-125.
- e) System only backup files with a ✓ before channel name. You can use Fn or cancel button to delete ✓ after file serial number.
- f) Click backup button, you can backup selected files. There is a process bar for you reference.
- g) When the system completes backup, you can see a dialogue box prompting successful backup.

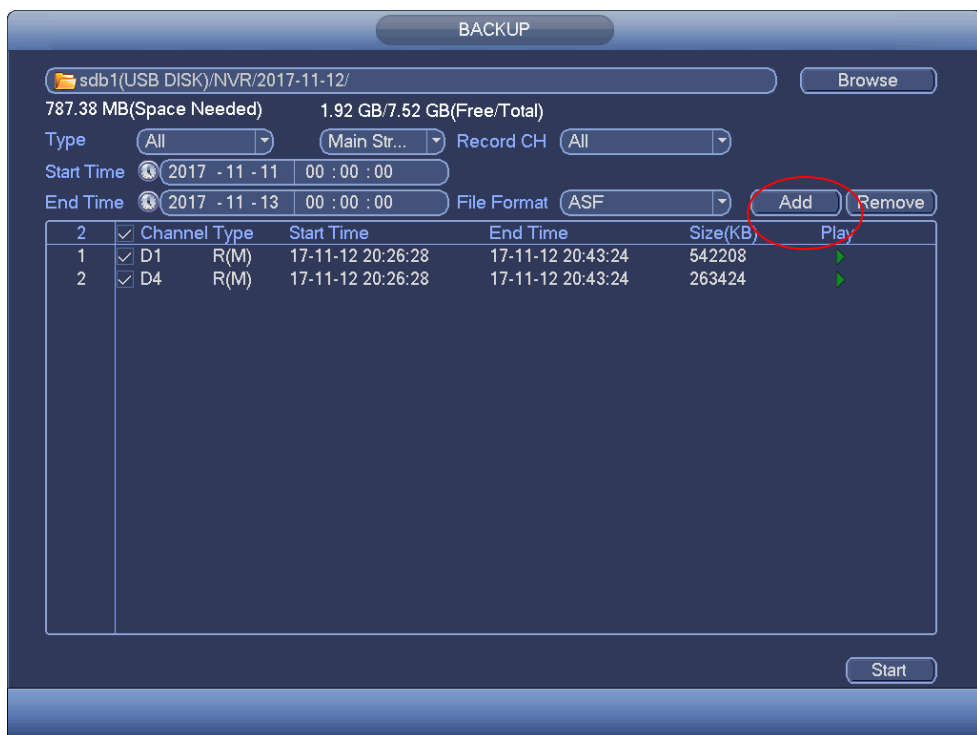

Figure 4-125

- h) Click backup button, system begins burning. At the same time, the backup button becomes stop button. You can view the remaining time and process bar at the left bottom.

 **Note**

- During backup process, you can click ESC to exit current interface for other operation (For some series product only). The system will not terminate backup process.
- The file name format usually is: Channel number+Record type+Time. In the file name, the YDM format is Y+M+D+H+M+S. File extension name is .dav.

4.10.5.2 Import/Export

This function allows you to copy current system configuration to other devices. It also supports import, create new folder, and delete folder and etc function.

From Main menu->Setting->System->Import/Export, you can see the configuration file backup interface is shown as below. See Figure 4-126.

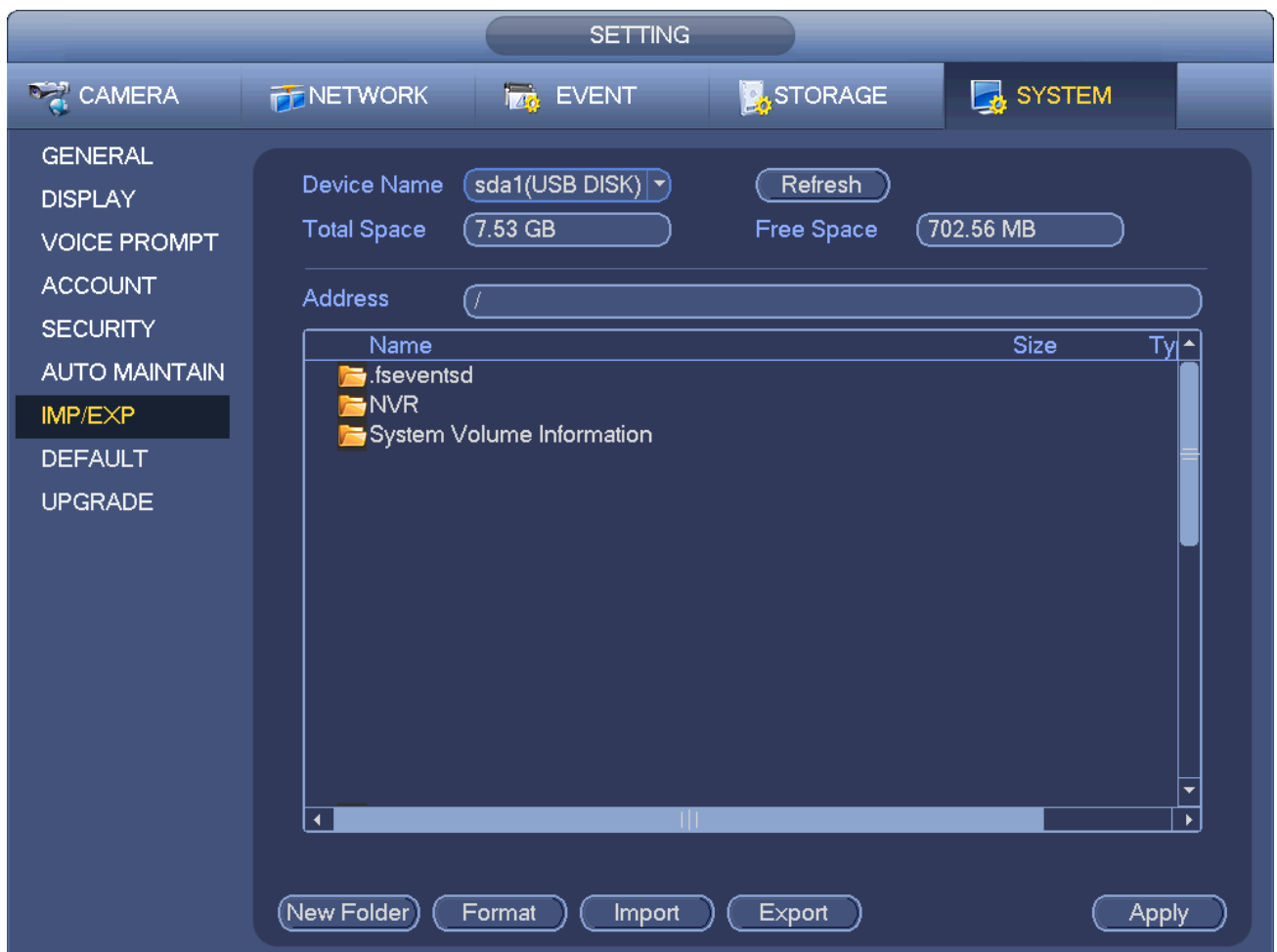

Figure 4-126

- Export: Please connect the peripheral device first and then go to the following interface. Click Export button, you can see there is a corresponding “Config_Time” folder. Double click the folder, you can view some backup files.
- Import: Here you can import the configuration files from the peripheral device to current device. You need to select a folder first. You can see a dialogue box asking you to select a folder if you are

selecting a file. System pops up a dialogue box if there is no configuration file under current folder. After successfully import, system needs to reboot to activate new setup.

- Format: Click Format button, system pops up a dialogue box for you to confirm current operation. System begins format process after you click the OK button.

Note

- System cannot open config backup interface again if there is backup operation in the process.
- System refreshes device when you go to the config backup every time and set current directory as the root directory of the peripheral device.
- If you go to the configuration backup interface first and then insert the peripheral device, please click Refresh button to see the newly added device.

4.10.5.3 Backup Log

a) From Main menu->Info->Log, the interface is shown as below. See Figure 4-127.



Figure 4-127

b) Select log type and then set start time/end time, click Search button, you can see log time and event information. Click  to view detailed log information.

c) Select log items you want to save and then click backup button, you can select a folder to save them. Click Start to backup and you can see the corresponding dialogue box after the process is finish.

4.10.5.4 USB Device Auto Pop-up

After you inserted the USB device, system can auto detect it and pop up the following dialogue box. It allows you to conveniently backup file, log, configuration or update system. See Figure 4-128. Please refer to chapter 4.10.5.1 file backup, chapter 4.10.5.3 backup log, chapter 4.10.5.2 import/export, and chapter 4.6.2 search for detailed information.



Figure 4-128

4.10.6 Default



Warning!

After you use default function, some your customized setup may lose forever! Please think twice before you begin the operation!

You can restore factory default setup to fix some problems when the device is running slowly. Configuration error occurred.

From Main menu->Setting->System->Default, you can go to the default interface. See Figure 4-129.

Check an item you want to restore default setup, or check the All to select all items.

Click OK or apply button, system pops up a dialogue box. Click OK to restore.



Figure 4-129

4.10.7 Upgrade

4.10.7.1 File Update

From Mani menu->Setting->Info->Update, you can go to the following interface. See Figure 4-130.

Step 1 Insert USB device that contain the upgrade file.

Step 2 Click Start button and then select the .bin file.

Step 3 You can see the corresponding dialogue box after the update process is complete.



Figure 4-130

4.10.7.2 Online Upgrade

When the NVR is online, you can use the online upgrade to update the firmware.

Before the online upgrade, system needs to detect if any new version is available. It includes auto check and manual check.

- Auto check: System automatically detects if any new version is available once in a while.
- Manual check: Detect new version at real time.



CAUTION

During the upgrade process, make sure that the network connection and power supply are normal.

Step 1 Enter from main menu > Setup > System > Upgrade.

The Upgrade interface is displayed. See Figure 4-131.



Figure 4-131

Step 2 Version check.

- Auto check: Select the Auto check for updates check box and click Save.

 **Note**

System enables this function by default.

- Manual check: Click Manual Check.
System starts to search new version and displays the result after the check is completed.
- When system displays that it is the latest version, the current version is the latest one and you do not need to upgrade it.
- When system displays the new version information (including release date and upgrade notes), new version is available and go to Step 3.

Step 3 Click Upgrade to upgrade the system.

4.10.7.3 Uboot

When NVR boots up, during the uboot process, NVR automatically detects there is USB device and there is upgrade file on the USB device or not. If the detection result is OK, NVR automatically begins upgrade.



CAUTION

- The USB device shall contain two files: u-boot.bin.img and update.img.
- The USB device shall connected to the USB port at the front panel. Otherwise, NVR cannot properly detect the file or upgrade.

4.11 Logout /Shutdown/Restart

From Mani menu->Operation->Shutdown, you can see an interface shown as in Figure 4-132.

- Shutdown: System shuts down and turns off power.
- Logout: Log out menu. You need to input password when you login the next time.
- Restart: reboot device.

If you shut down the device, there is a process bar for your reference, system waits for 3 seconds and then shut down (You cannot cancel).

Please note, sometimes you need to input the proper password to shut down the device.



Figure 4-132

5 Web Operation

5.1 General Introduction

If it is your first time to login the device, please initialize your device first. Refer to chapter 5.2 Device Initialization for detailed information.

The device web provides channel monitor menu tree, search, alarm setup, system setup, PTZ control and monitor window and etc.



Note

- Slight difference may be found on user interface. Please refer to the actual product for detailed information.
- Device supports various browsers such as Safari, Chrome and etc.
- Use ChromeApp to login the WEB if the Chrome version is 45 or higher. Go to the Chrome online store to download the ChromeApp installation package.

5.1.1 Preparation

Step 1 PC and NVR connection is OK.

Step 2 Set PC IP address, NVR IP address, subnet mask and gateway.

- Set the IP address of the same section for the PC and NVR. Input corresponding gateway and subnet mask if there are routers.)
- The device default IP address is 192.168.1.108.

Step 3 Check the PC and device connection is OK or not. Refer to the following two ways to check the network connection is OK or not. When the PC and device network connection is OK, login the WEB via the PC.

- On PC, use order ping `***.***.***.***`(NVR IP address) to check connection is OK or not. Login Usually the TTL value is 255.
- Login the device local menu, from setting->Network->Network test and then input PC IP address. Check the connection is OK or not.

Step 4 Login the WEB. Refer to chapter 5.9 Login for detailed information.

5.2 Device Initialization

If it is your first time to use the device, please set a login password of **admin** (system default user).



Note

For your device safety, please keep your login password of **admin** well after the initialization steps, and change the password regularly.

Please follow the steps listed below.

Step 1 Open the IE and then input the NVR IP address in the address column.

Step 2 Click Enter button.

Device displays device initialization interface. See Figure 5-1.

Figure 5-1

Step 3 Set login password of **admin**.

- User name: The default user name is **admin**.
- Password/confirm password: The password ranges from 8 to 32 digitals. It can contain letters, numbers and special characters (excluding “”, “()”, “,”, “:”, “&”). The password shall contain at least two categories. Usually we recommend the strong password.



WARNING

STRONG PASSWORD RECOMMENDED-For your device own safety, please create a strong password of your own choosing. We also recommend you change your password periodically especially in the high security system.

Step 4 Click Next, device goes to the following interface. See Figure 5-2.

Figure 5-2

Step 5 Set security questions.

 **Note**

- After setting the security questions here, you can use the email you input here or answer the security questions to reset **admin** password Refer to chapter 5.4 Reset password for detailed information.
- Cancel the email or security questions box and then click Next button to skip this step.
- Email: Input an email address for reset password purpose. Scan the QR code to reset the password, you need to receive the security code by the email. Input the security code to reset the password of **admin**. In case you have not input email address here or you need to update the email information, please go to the main Setup->System->Account to set. Refer to chapter 5.10.5.4 for detailed information.
- Security question: Set security questions and corresponding answers. Properly answer the questions to reset **admin** password. In case you have not input security question here or you need to update the security question information, please go to the main menu->Setting->System->Account->Security question to set. Refer to chapter 4.10.1.3 Security question for detailed information.

 **Note**

If you want to reset password by answering security questions, please go to the local menu interface.

Step 6 Click OK to complete the device initialization setup. See Figure 5-3.

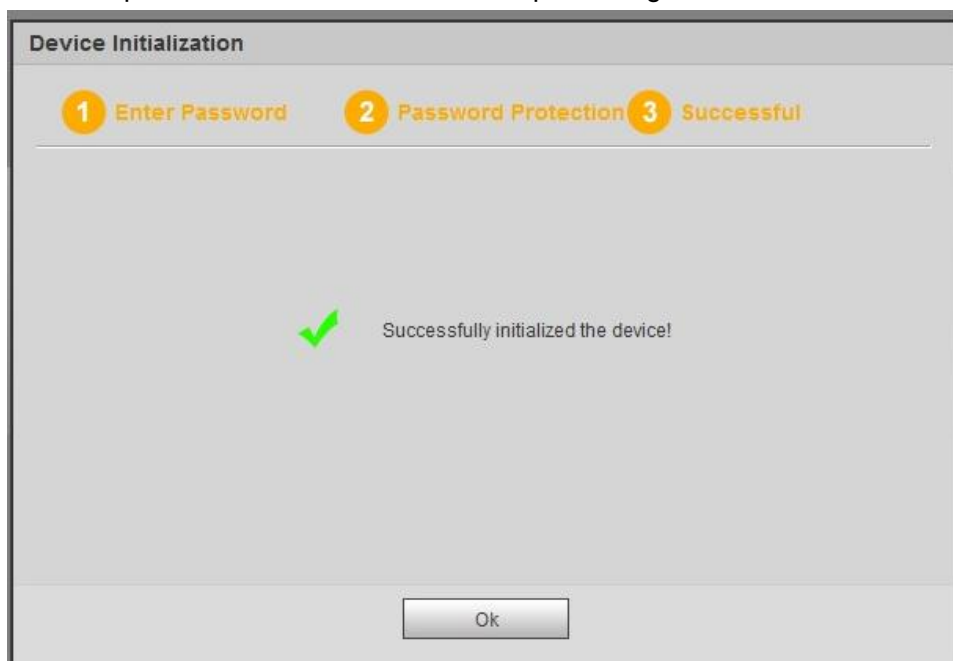

Figure 5-3

5.3 Log in

Open the IE and then input the NVR IP address in the address column.

For example, if your NVR IP address is 192.168.1.108, then please input http:// 192.168.1.108 in IE address column. See Figure 5-4.

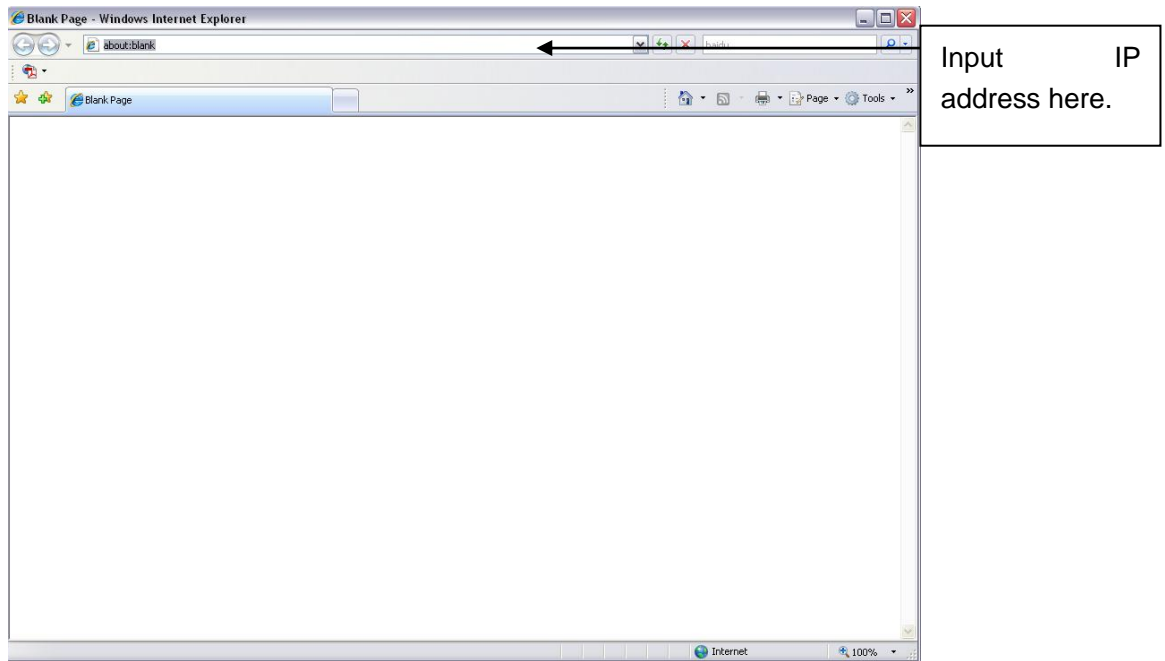

Figure 5-4

System pops up warning information to ask you whether install Web plug-in or not. Please click yes button.

After installation, the interface is shown as below. See Figure 5-5.

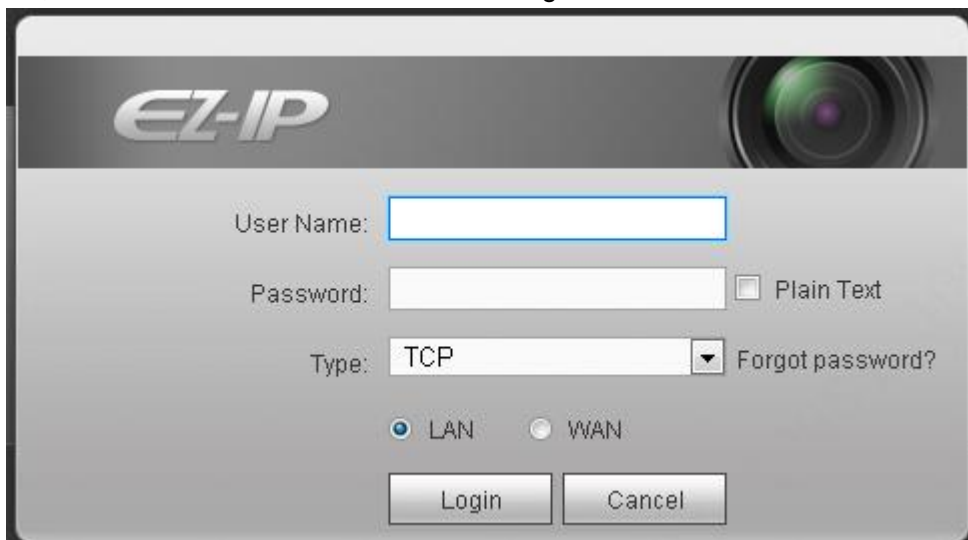

Figure 5-5

Please input your user name and password.

Factory default user name is **admin** and password is what you set in chapter 5.2 Device initialization.

5.4 Reset Password

If you forgot **admin** password, you can reset the password by email or by answering the security questions (local menu only).

- When the password reset function is enabled, you can scan the QR code on the Web to reset the password.
- When the password reset function is disabled, you can reset password via the security questions

configured before. If the security questions are not configured, system displays that Password reset is closed! You need to contact the customer service for help.

Step 1 Go to the device login interface. See Figure 5-6.

The image shows the EZ-IP login interface. At the top left is the 'EZ-IP' logo. To the right is a camera lens icon. Below the logo, there are input fields for 'User Name:' and 'Password:'. The 'Password:' field has a checkbox labeled 'Plain Text'. Below the password field is a dropdown menu for 'Type:' with 'TCP' selected, and a link for 'Forgot password?'. At the bottom, there are radio buttons for 'LAN' (selected) and 'WAN'. Two buttons, 'Login' and 'Cancel', are at the bottom center.

Figure 5-6

Step 2 Click Forgot password.

- If you have set the reserved email, system displays a notice before the password reset. See Figure 5-7.
- If you have not set the reserved email, a dialogue box pops up that asks you to reset the password by clicking Forgot password on the local interface.

The image shows a dialog box titled 'Reset Password(1/3)'. It contains a red warning icon and the following text: 'In order to provide a secure password reset environment, we need to collect your e-mail address, device MAC address, device SN, etc. All collected info is used only for the purposes of verifying device validity and sending a security code to you. Do you agree and want to continue the operation?'. At the bottom, there are 'Cancel' and 'OK' buttons.

Figure 5-7

Step 3 Click OK.

System enters the following interface. See Figure 5-8.

 **Note**

After clicking OK, we will collect your personal information such as cell phone number, MAC address and device serial number. The collected information is used for verifying device legality and sending security code. Please read the notice carefully and confirm if you agree with the collection or not.

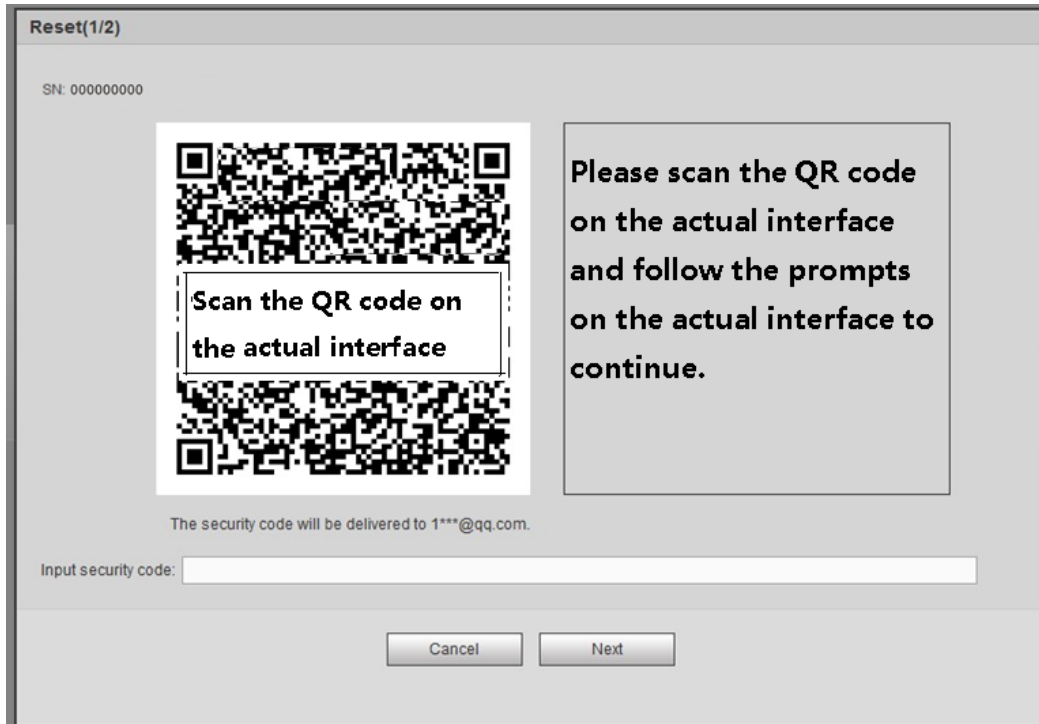

Figure 5-8

Step 4 Follow the prompts on the interface and then scan the QR code to get the security code.



WARNING

- ✧ For the same QR code, max scan twice to get two security codes. Refresh the QR code if you want to get security code again.
- ✧ The security code on you email is only valid for 24 hours.
- ✧ After five times security code failure, the **admin** account will be locked for 5 minutes.

Step 5 Input the security code on the email and then click Next button.

Step 6 Input new password and then confirm.



WARNING

The password can be set from 8 characters through 32 characters and contain at least two types from number, letter and special character (excluding "", "", ";", ":" and "&"). It is recommended to set password of high security according to the prompts.

Step 7 Click OK button to complete the setup.

5.5 LAN Mode

For the LAN mode, after you logged in, you can see the main window. See Figure 5-9.



Figure 5-9

This main window can be divided into the following sections.

- Section 1: there are six function buttons: Live (chapter 5.6), setup (chapter 5.10), info (Chapter 5.11), playback (chapter 5.12), alarm (chapter 5.13), and logout (chapter 5.14).
- Section 2: There are monitor channels successfully connected to the NVR. Please refer to Figure 5-10 for main stream and extra stream switch information.

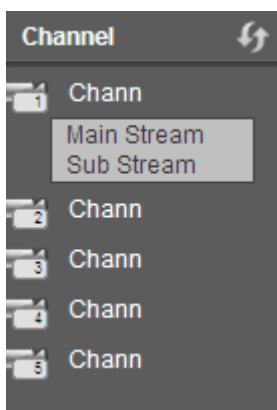

Figure 5-10

- Section 3: Open all. Open all button is to enable/disable all-channel real-time monitor. Here you can select main stream/sub stream too. See Figure 5-11.

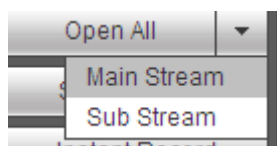

Figure 5-11

- Section 4: Start Talk button.

You can click this button to enable audio talk. Click 【▼】 to select bidirectional talk mode. There are four options: DEFAULT, G711a, G711u and PCM. See Figure 5-12.

After you enable the bidirectional talk, the Start talk button becomes End Talk button and it becomes

yellow. Please note, if audio input port from the device to the client-end is using the first channel audio input port. During the bidirectional talk process, system will not encode the audio data from the 1-channel.

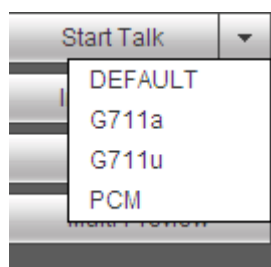

Figure 5-12

- Section 5: Instant record button. Click it, the button becomes yellow and system begins manual record. See Figure 5-13. Click it again, system restores previous record mode.

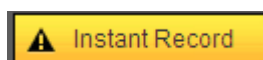

Figure 5-13

- Section 6: Local play button.

The Web can playback the saved (Extension name is dav) files in the PC-end.

Click local play button, system pops up the following interface for you to select local play file. See Figure 5-14.



Figure 5-14

- Section 7: PTZ operation panel. Please refer to chapter 5.7 for detailed information.
- Section 8: Image setup and alarm setup. Please refer to chapter 5.8 for detailed information.
- Section 9: From the left to the right, you can see video quality/fluency/ full screen/1-window/4-window. You can set video fluency and real-time feature priority.

5.6 Real-time Monitor

In section 2, left click the channel name you want to view, you can see the corresponding video in current window.

On the top left corner, you can view device IP(172.11.10.11), channel number(1), network monitor bit stream(2202Kbps) and stream type(M=main stream, S=sub stream). See Figure 5-15.

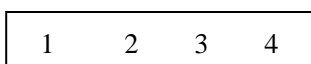



Figure 5-15

On the top right corner, there are six unction buttons. See Figure 5-16.

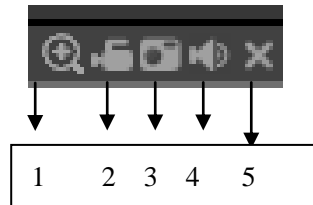

Figure 5-16

- 1: Digital zoom: Click this button and then left drag the mouse in the zone to zoom in. right click mouse system restores original status.
- 2: Local record. When you click local record button, the system begins recording and this button becomes highlighted. You can go to system folder RecordDownload to view the recorded file.
- 3: Snapshot picture. You can snapshot important video. All images are memorized in system client folder PictureDownload (default).
- 4: Audio :Turn on or off audio.(It has no relationship with system audio setup)
- 5: Close video.

5.7 PTZ

There are eight direction keys. In the middle of the eight direction keys, there is a 3D intelligent positioning key.

Click 3D intelligent positioning key, system goes back to the single screen mode. Drag the mouse in the screen to adjust section size. It can realize PTZ automatically.

Please refer to the following sheet for PTZ setup information.

Parameter	Function
Scan	<ul style="list-style-type: none"> ● Select Scan from the dropdown list. ● Click Set button, you can set scan left and right limit. ● Use direction buttons to move the camera to you desired location and then click left limit button. Then move the camera again and then click right limit button to set a right limit.
Preset	<ul style="list-style-type: none"> ● Select Preset from the dropdown list. ● Turn the camera to the corresponding position and Input the preset value. Click Add button to add a preset.
Tour	<ul style="list-style-type: none"> ● Select Tour from the dropdown list. ● Input preset value in the column. Click Add preset button, you have added one preset in the tour. ● Repeat the above procedures you can add more presets in one tour. ● Or you can click delete preset button to remove one preset from the tour.

Parameter	Function
Pattern	<ul style="list-style-type: none"> ● Select Pattern from the dropdown list. ● You can input pattern value and then click Start button to begin PTZ movement such as zoom, focus, iris, direction and etc. Then you can click Add button to set one pattern.
Aux	<ul style="list-style-type: none"> ● Please input the corresponding aux value here. ● You can select one option and then click AUX on or AUX off button.
Light and wiper	You can turn on or turn off the light/wiper.

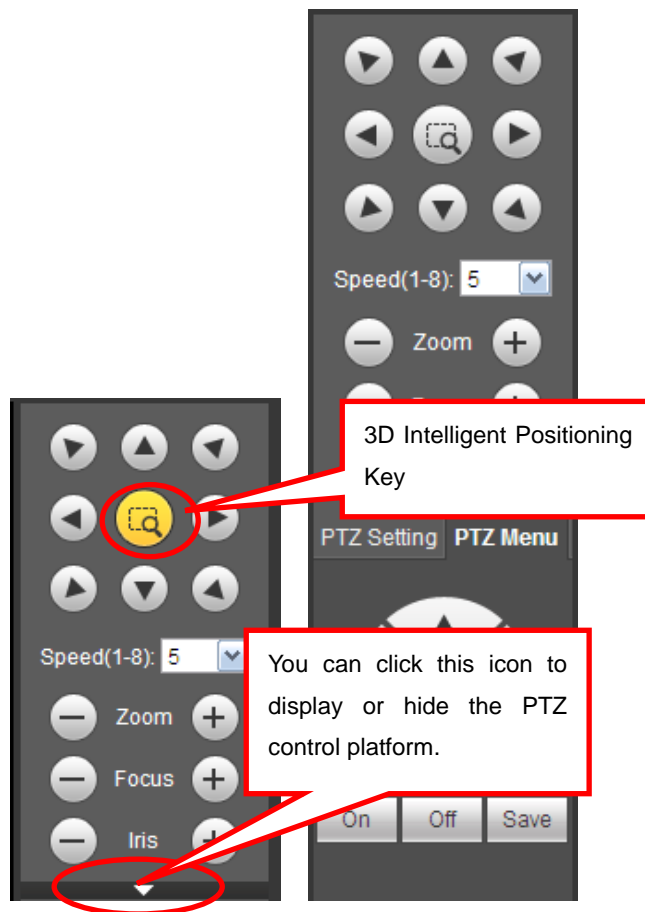

Figure 5-17

5.8 Image/Alarm-out

Select one monitor channel video and then click Image button in section 9, the interface is shown as Figure 5-18.

5.8.1 Image

Here you can adjust its brightness, contrast, hue and saturation. (Current channel border becomes green).

Or you can click Reset button to restore system default setup.

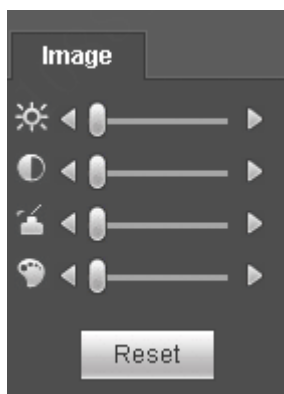

Figure 5-18

5.9 WAN Login

In WAN mode, after you logged in, the interface is shown as below. See Figure 5-19.

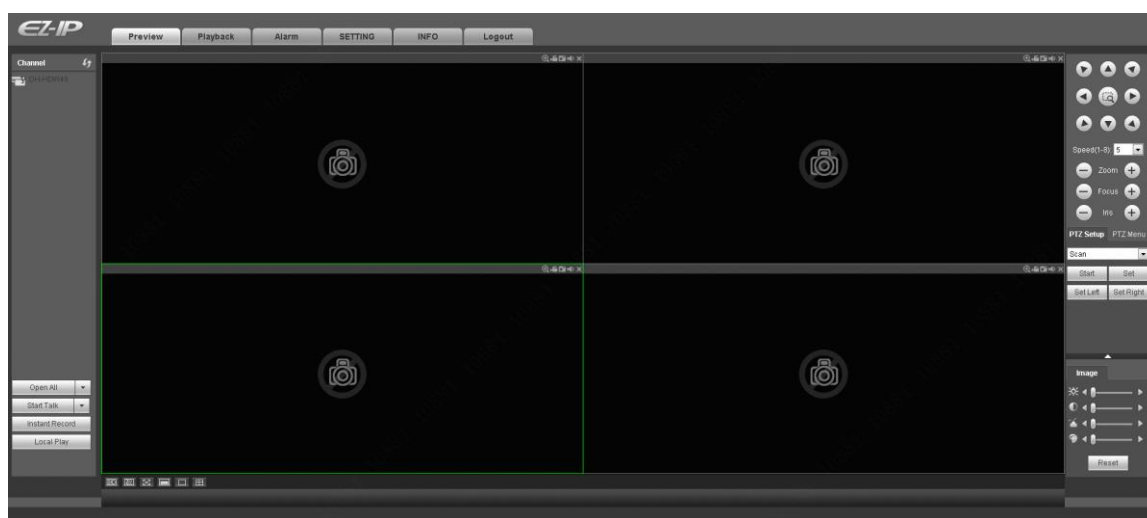

Figure 5-19

Please refer to the following contents for LAN and WAN login difference.

- 1) In the WAN mode, system opens the main stream of the first channel to monitor by default. The open/close button on the left pane is null.
- 2) You can select different channels and different monitor modes at the bottom of the interface.

Important

The window display mode and the channel number are by default. For example, for the 16-channel, the max window split mode is 16.

- 3) Multiple-channel monitor, system adopts extra stream to monitor by default. Double click one channel, system switches to single channel and system uses main stream to monitor. You can view there are two icons at the left top corner of the channel number for you reference. M stands for main stream. S stands for sub stream (extra stream).

- 4) If you login via the WAN mode, system does not support alarm activation to open the video function in the Alarm setup interface.

Important

- For multiple-channel monitor mode, system adopts extra stream to monitor by default. You cannot modify manually. All channels are trying to synchronize. Please note the synchronization effect still depends on your network environments.
- For bandwidth consideration, system cannot support monitor and playback at the same time. System auto closes monitor or playback interface when you are searching setup in the configuration interface. It is to enhance search speed.

5.10 Setup

5.10.1 Camera

5.10.1.1 Registration

5.10.1.1.1 Registration

From Main menu->Setup->Camera->Registration->Registration, you can see the following interface. See Figure 5-20.

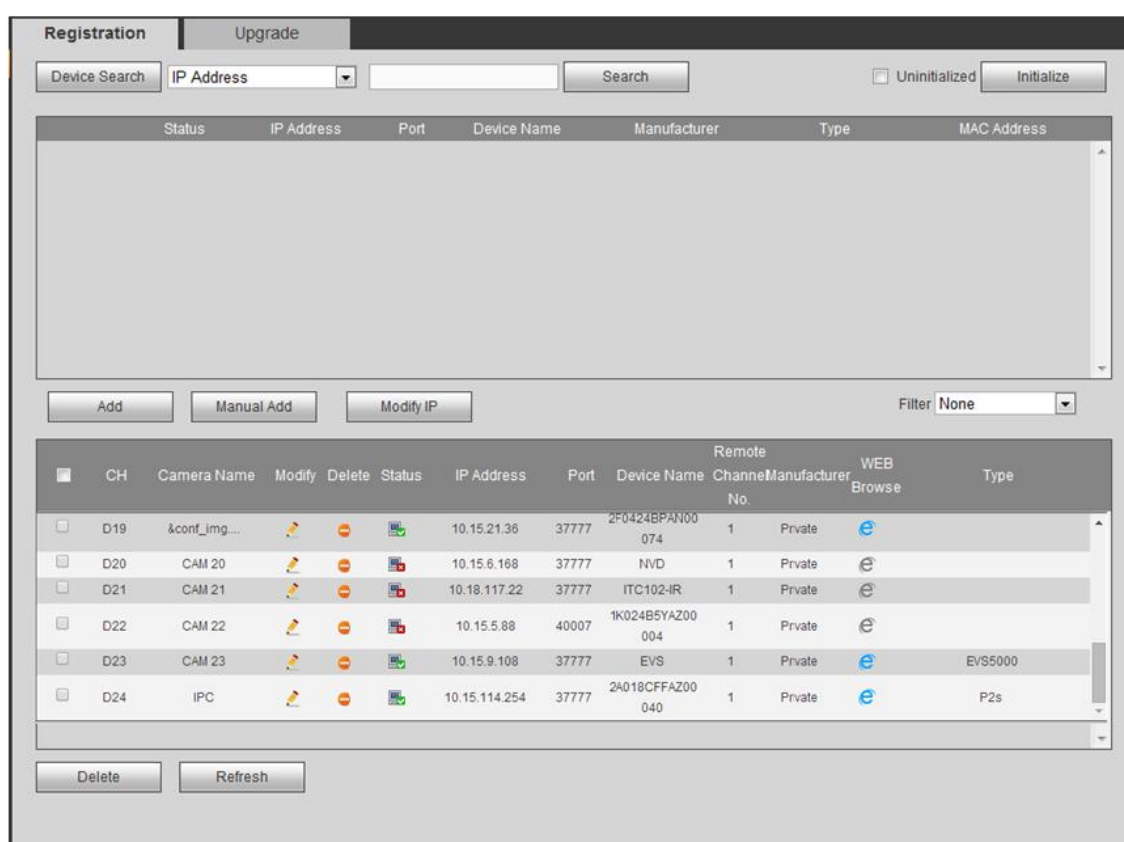









Figure 5-20

Please refer to the following sheet for parameter information.

Parameter	Function
IP Address	Select IP address or the MAC address from the dropdown list and then input the corresponding information, click Search button to view the results.
Search	Click Search button, you can view the searched device information on the list. It includes device IP address, port, device name, manufacturer and type.
Uninitialized	Click to search the initialized devices. Select an uninitialized device and then click the Initialize button to set the account.

Parameter	Function
Preview	Click  to view the preview video of the remote device.
State	It is to display the device has been initialized or not. That is to say, the remote device has set the initial account information or not.  means the remote device has initialized,  means the remote device has not been initialized.
Add	Select a device in the list and then click Add button, system can connect the device automatically and add it to the Added device list. Or you can double click one item in the list to add a device.
Modify	Click  or any device in the Added device list, you can change the corresponding channel setup.
Delete	Click  , you can delete the remote connection of the corresponding channel.
Type	There are two connection types. You can use the network to connect to the camera or use the WIFI. The  means current network camera connection mode is general; the  means current network camera mode is hotspot.
Delete	Select a device in the Added device list and then click Delete button, system can disconnect the device and remove it from the Added device list.
Manual Add	Click it, the interface is shown as in Figure 5-26. Here you can add network camera manually. You can select a channel from the dropdown list (Here only shows disconnection channel.)

Initialize Camera

It is to initialize connected remote device and change its login password and IP address.

Steps:

Step 1 From main interface->Setting->Camera->Registration.

Enter Registration interface. See Figure 5-21.

Step 2 Click IP search and check the Uninitialized box.

Device displays uninitialized camera.

Enter input email interface. See Figure 5-23.

Email: Input an email address for reset password purpose.

 **Note**

Cancel the box and then click Next or Skip if you do not want to input email information here.



The dialog box titled "Password Protection" contains a checked checkbox labeled "Email Address" next to an empty text input field. To the right of the input field is the text: "To reset password, please input properly or update in time". At the bottom of the dialog are three buttons: "Back", "Next", and "Skip".

Figure 5-23

Step 6 Click Next button.

Enter Modify IP address interface. See Figure 5-24.

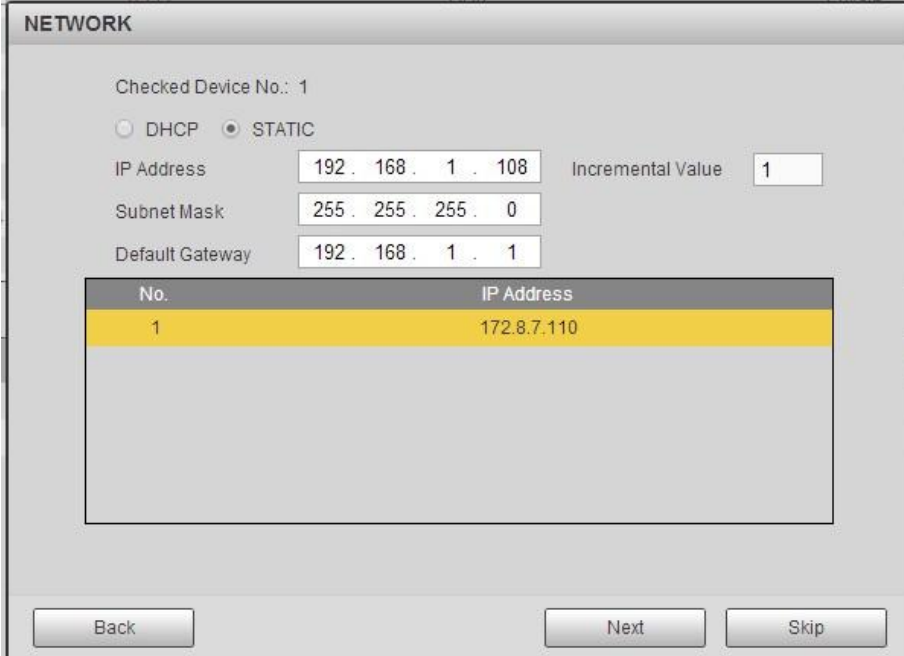

The "NETWORK" dialog box shows "Checked Device No.: 1". It has radio buttons for "DHCP" (unchecked) and "STATIC" (checked). Below are input fields for "IP Address" (192 . 168 . 1 . 108), "Subnet Mask" (255 . 255 . 255 . 0), and "Default Gateway" (192 . 168 . 1 . 1). An "Incremental Value" field contains "1". A table below lists IP addresses:

No.	IP Address
1	172.8.7.110

At the bottom are "Back", "Next", and "Skip" buttons.

Figure 5-24

Step 7 Set camera IP address.

- Check DHCP, there is no need to input IP address, subnet mask, and default gateway. Device automatically allocates the IP address to the camera.

- Check Static, and then input IP address, subnet mask, default gateway and incremental value.

 **Note**

- If it is to change several devices IP addresses at the same time, please input incremental value. Device can add the fourth address of the IP address one by one to automatically allocate the IP addresses.
- If there is IP conflict when changing static IP address, device pops up IP conflict dialogue box. If batch change IP address, device automatically skips the conflicted IP and begin the allocation according to the incremental value

Step 8 Click Next button.

Device begins initializing camera. See Figure 5-25.

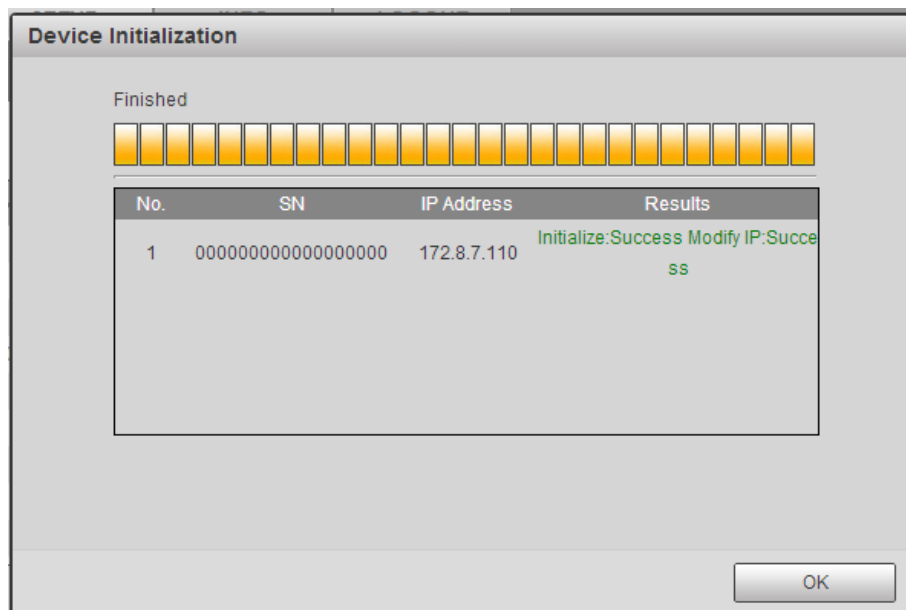





Figure 5-25





Step 9 Click OK to complete the initialization.

Manual Add

Figure 5-26

Please refer to the following sheet for parameter information.

Parameter	Function
Manufacturer	Please select from the dropdown list.  Note Different series products may support different manufacturers, please refer to the actual product.
IP address	Input remote device IP address.
RTSP mode	Input RTSP mode of the remote device, including self-adaptive and customized.  Note Skip this item if the manufacture is private or customized.
HTTP port	Input HTTP port of the remote device. The default setup is 80.  Note Skip this item if the manufacture is private or customize.
TCP port	Input TCP port of the remote device. The default setup is 37777.
User name/password	The user name and password to login the remote device.

Parameter	Function
Channel No.	<p>Input channel amount or click the Connect button to get the channel amount of the remote device.</p> <p> Note</p> <p>We recommend click Connect button to get remote device channel amount, the manual add operation may result in failure if the input channel amount is not right.</p>
Remote channel No.	<p>After getting the remote device channel amount, click Setup to select a channel.</p> <p> Note</p> <p>Click to select one or more remote channel numbers here.</p>
Channel	The local channel number you want to add. One channel name has corresponding one channel number.
Decode buffer	There are three item: realtime, local, fluent.
Service type	<p>There are four items: auto/TCP/UDP/MULTICAST(ONVIF device only)</p> <p> Note</p> <ul style="list-style-type: none"> The default connection mode is TCP if the connection protocol is private. There are four items including Auto, TCP, UDP and MULTICAST if the connection protocol is ONVIF. There are two items: TCP/UDP if the connection protocol is from the third-party.
Encrypt	<p>When the connection protocol is ONVIF, enable the encryption function and system transmits data in the encrypted mode.</p> <p> Note</p> <p>System supports this function when HTTPS is enabled in IPC.</p>

Change IP

On the searched devices list, check one or more device(s) at the same time. Click Modify IP button, you can see the following interface. See Figure 5-27

Please refer to the following sheet for log parameter information.

Parameter	Function
DHCP	Check the box here, system can auto allocate the IP address. The IP address, subnet mask, default gateway are reference only.
Static	Check the box here, you can set IP address, subnet mask, default gateway manually.
IP address/subnet mask/default gateway	You can input corresponding information here.

Parameter	Function
User name/password	The account you login the remote device. Please input here to password verification to change the remote device password.
Incremental value	When you want to change several IP addresses, once you input the IP address of the first device, the IP address of the next device will increase accordingly. For example, when the incremental value is 1, if the IP address of the first device is 172.10.3.128, the IP address of the second device will auto be set as 172.10.3.129.

Note

For the static IP address, system will alert you if there is any IP conflict. If you are changing several IP addresses at the same time, system auto skip the conflicted IP and auto allocate again according to the incremental value you set.

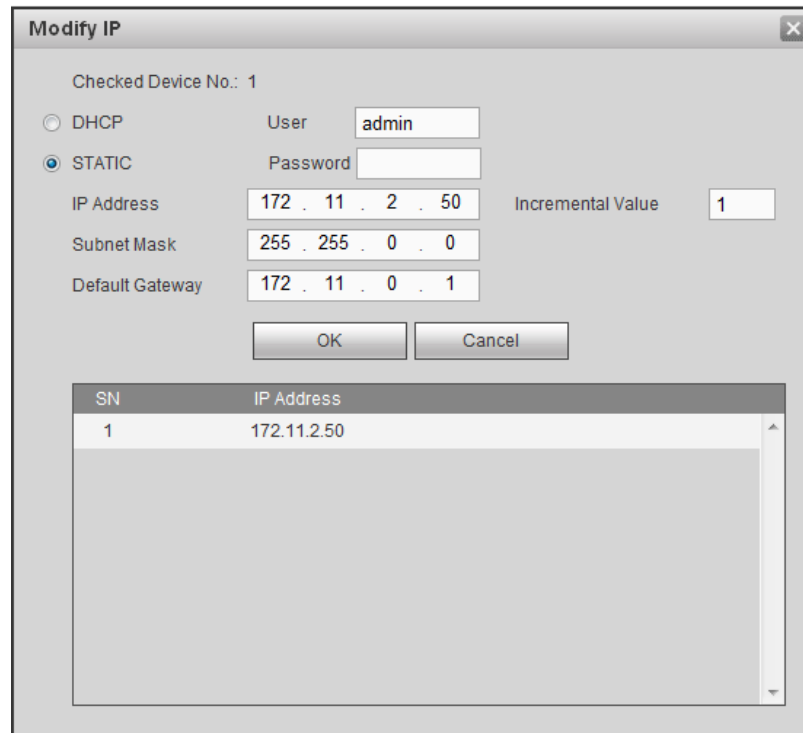

Figure 5-27

Export IP

System supports to export the registered device list and save it in the USB device.

Step 1 Inset the USB device and click Export.

The File Backup Encryption interface is displayed. See Figure 5-28.

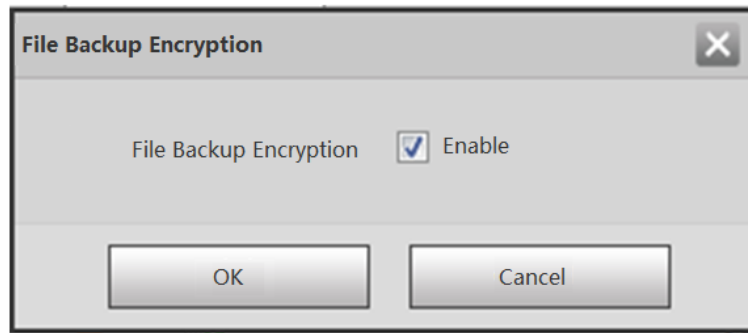

Figure 5-28

Step 2 File backup encryption is enabled by default. Click OK to select the save path.

Step 3 Click Save. After the export is completed, system pops up a dialogue box to show that backup is completed.

Note

Backup encryption is enabled by default when exporting IP. The file contains information such as IP address, port, remote channel number, manufacturer, username and password.

- If file backup encryption is enabled, the extension name of the exported file is .backup. Except the NVR device, any other software cannot open and edit the file.
- If the backup encryption is disabled, the extension name of the exported file is .csv. It might lead to data leakage.

Import IP

You can import the added device list to add the device conveniently.

Click Import button, and then select the import file.

Note

If the imported IP is already in the added device list, system pops up dialogue box for you to confirm overwrite or not.

- Click OK button, the new IP setup can overwrite the old one.
- Click Cancel button, system adds the new IP setup.



Important

- You can edit the exported file. Please make sure the file format is the same. Otherwise you cannot import the file again!
- System does not support customized protocol import/export.
- The import/export function is for the devices of the same language.

5.10.1.1.2 IPC Upgrade

This interface is to upgrade network camera.

From Main menu->Setting->Camera->Registration->IPC upgrade, enter the following interface. See Figure 5-29.

Click Browse button to select upgrade file. Or you can use filter to select several network cameras at the

same time.



Figure 5-29

5.10.1.2 Image

Note

Slight difference may be found since the connected network camera may not be same model.

Here you can view device property information. The setups become valid immediately after you set. See Figure 5-30.

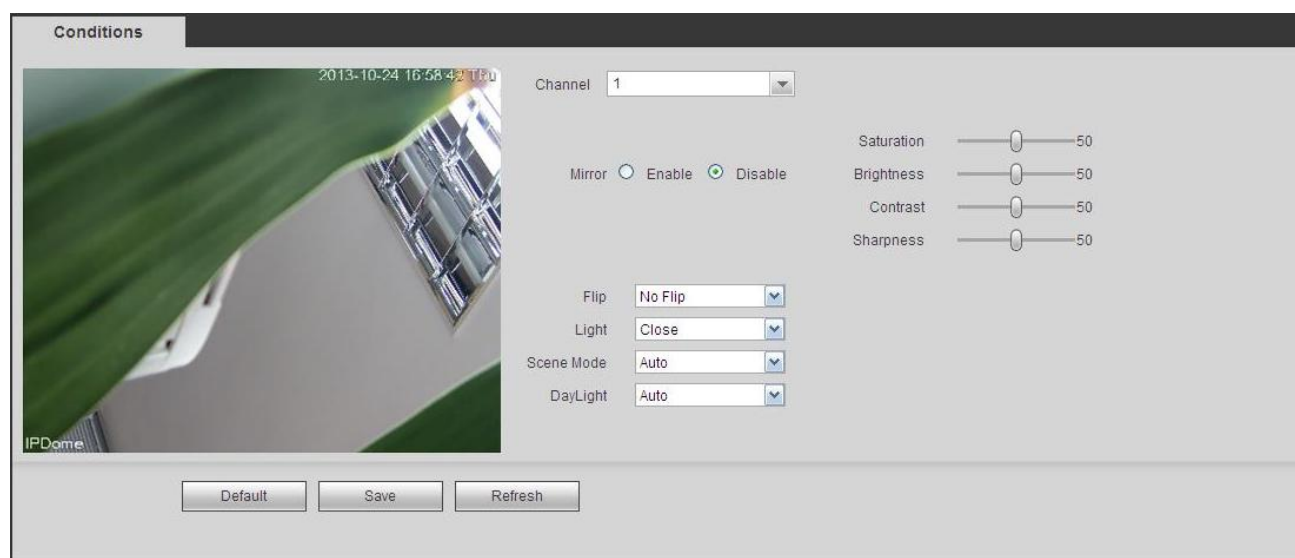

Figure 5-30

Please refer to the following sheet for detailed information.

Parameter	Function
Channel	Please select a channel from the dropdown list.
Period	It divides one day (24 hours) to two periods. You can set different hue, brightness, and contrast for different periods.
Hue	It is to adjust monitor video brightness and darkness level. The default value is 50. The bigger the value is, the large the contrast between the bright and dark section is and vice versa.
Brightness	It is to adjust monitor window brightness. The default value is 50. The larger the number is, the bright the video is. When you

		input the value here, the bright section and the dark section of the video will be adjusted accordingly. You can use this function when the whole video is too dark or too bright. Please note the video may become hazy if the value is too high. The value ranges from 0 to 100. The recommended value ranges from 40 to 60.
Contrast		It is to adjust monitor window contrast. The value ranges from 0 to 100. The default value is 50. The larger the number is, the higher the contrast is. You can use this function when the whole video bright is OK but the contrast is not proper. Please note the video may become hazy if the value is too low. If this value is too high, the dark section may lack brightness while the bright section may over exposure. The recommended value ranges from 40 to 60.
Saturation		It is to adjust monitor window saturation. The value ranges from 0 to 100. The default value is 50. The larger the number is, the strong the color is. This value has no effect on the general brightness of the whole video. The video color may become too strong if the value is too high. For the grey part of the video, the distortion may occur if the white balance is not accurate. Please note the video may not be attractive if the value is too low. The recommended value ranges from 40 to 60.
Gain		The gain adjust is to set the gain value. The smaller the value is, the low the noise is. But the brightness is also too low in the dark environments. It can enhance the video brightness if the value is high. But the video noise may become too clear.
White level		It is to enhance video effect.
Color mode		It includes several modes such as standard, color. You can select corresponding color mode here, you can see hue, brightness, and contrast and etc will adjust accordingly.
Auto Iris		It is to enable/disable auto iris function.
Flip		It is to switch video up and bottom limit. This function is disabled by default.
Mirror		It is to switch video left and right limit. This function is disabled by default.
BLC Mode	BLC	The device auto exposures according to the environments situation so that the darkest area of the video is cleared
	WDR	For the WDR scene, this function can lower the high bright section and enhance the brightness of the low bright section. So that you can view these two sections clearly at the same time. The value ranges from 1 to 100. When you switch the camera from no-WDR mode to the WDR mode, system may lose several seconds record video.
	HLC	After you enabled HLC function, the device can lower the brightness of the brightest section according to the HLC control level. It can reduce the area of the halo and lower the brightness of the whole video.

	Off	It is to disable the BLC function. Please note this function is disabled by default.
Profile		<p>It is to set the white balance mode. It has effect on the general hue of the video. This function is on by default.</p> <p>You can select the different scene mode such as auto, sunny, cloudy, home, office, night, disable and etc to adjust the video to the best quality.</p> <ul style="list-style-type: none"> ● Auto: The auto white balance is on. System can auto compensate the color temperature to make sure the vide color is proper. ● Sunny: The threshold of the white balance is in the sunny mode. ● Night: The threshold of the white balance is in the night mode. ● Customized: You can set the gain of the red/blue channel. The value reneges from 0 to 100.
Day/Night		<p>It is to set device color and the B/W mode switch. The default setup is auto.</p> <ul style="list-style-type: none"> ● Color: Device outputs the color video. ● Auto: Device auto select to output the color or the B/W video according to the device feature (The general bright of the video or there is IR light or not.) ● B/W: The device outputs the black and white video. ● Sensor: It is to set when there is peripheral connected IR light.

5.10.1.3 Encode

5.10.1.3.1 Encode

The encode interface is shown as below. See Figure 5-31.

The screenshot shows the 'Encode' configuration interface with the following settings:

- Channel:** D1
- Main Stream:**
 - Code-Stream Type: Regular
 - Compression: H.264H
 - Resolution: 1280x960(1.3M)
 - Frame Rate(FPS): 1
 - Bit Rate Type: CBR
 - Bit Rate: 512 Kb/S
 - Reference Bit Rate: 1-24576Kb/S
- Sub Stream:**
 - Video Enable
 - Compression: H.264H
 - Resolution: 352x288(CIF)
 - Frame Rate(FPS): 1
 - Bit Rate Type: CBR
 - Bit Rate: Customized
 - Bit Rate: 112 Kb/S
 - Reference Bit Rate: 1-24576Kb/S
- Watermark Enable
- Watermark String: [Empty text box]

Buttons at the bottom: Copy, Save, Refresh.

Figure 5-31

Please refer to the following sheet for detailed information.

Parameter	Function
-----------	----------

Channel	Please select a channel from the dropdown list.
Video enable	Check the box here to enable extra stream video. This item is enabled by default.
Code stream type	<p>It includes main stream, motion stream and alarm stream. You can select different encode frame rates form different recorded events.</p> <p>System supports active control frame function (ACF). It allows you to record in different frame rates.</p> <p>For example, you can use high frame rate to record important events, record scheduled event in lower frame rate and it allows you to set different frame rates for motion detection record and alarm record.</p>
Compression	<p>Video encode mode.</p> <ul style="list-style-type: none"> ● H.264: Main Profile encode mode. ● H.264H: High Profile encode mode. ● H.264B: Baseline Profile encode mode. ● H.265: Main Profile encode mode. ● MJPEG: System needs high bit streams to guarantee video definition. Use the recommended max bit stream value to get the better video effect.
Smart Codec	<p>This function is to reduce bit streams.</p> <p> Note</p> <ul style="list-style-type: none"> ● Some series products support smart codec function. ● After changing smart code, please reboot network camera and some network camera functions (such as IVS, ROI, SVC, lobby mode and etc.) becomes null. Please think twice before the operation.
Resolution	The resolution here refers to the capability of the network camera.
Frame Rate	The video frame amount displayed in each second. The higher the frame rate is, the clearer and more fluent the video is. The frame rate may vary depending on the resolution.
Bit Rate	<ul style="list-style-type: none"> ● Main stream: You can set bit rate here to change video quality. The large the bit rate is, the better the quality is. Please refer to recommend bit rate for the detailed information. ● Extra stream: In CBR, the bit rate here is the max value. In dynamic video, system needs to low frame rate or video quality to guarantee the value. The value is null in VBR mode.
Bit rate type	<p>System supports two types: CBR and VBR.</p> <ul style="list-style-type: none"> ● Main stream: It is to set frame rate to change video quality. The higher the frame rate is, the better the video quality is. The referenced bit rate is the recommended value. ● Sub stream: In CBR mode, the bit stream is near the specified value. In VBR mode, the video quality changes

	according to the bit stream value. But its max value is near the specified value. Reference bit rate: The reference bit rate depends on the resolution and frame rate you set.
Reference bit rate	Recommended bit rate value according to the resolution and frame rate you have set.
I Frame	Here you can set the P frame amount between two I frames. The value ranges from 1 to 150. Default value is 50. Recommended value is frame rate *2.
Video/audio	You can enable or disable the video/audio. The main stream is enabled by default. After enable the audio function, the record file is composite file consisting of the video and audio. For the sub stream 1, please enable video first and then enable audio function.
Audio format	Set audio encode format.  Note Different series products support different audio encode mode. Please refer to the actual interface for detailed information.
Sampling rate	Audio sampling rate refers to the sampling amount within 1 second. The higher the value is, the better the audio is. The default setup is 8K.
Watermark enable	This function allows you to verify the video is tampered or not. Here you can select watermark bit stream, watermark mode and watermark character. Default character is DigitalCCTV. The max length is 85-digit. The character can only include number, character and underline.

5.10.1.3.2 Snapshot

The snapshot interface is shown as in Figure 5-32.

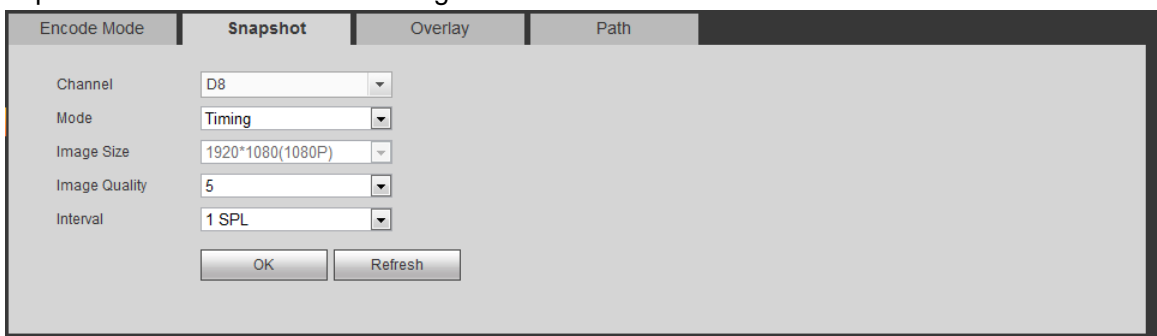

Figure 5-32

Please refer to the following sheet for detailed information.

Parameter	Function
Snapshot type	There are two modes: Regular (schedule) and Trigger. <ul style="list-style-type: none"> ● Regular snapshot is valid during the specified period you set. ● Trigger snapshot only is valid when motion detect alarm, tampering alarm or local activation alarm occurs.

Image size	It is the same with the resolution of the main stream.
Quality	It is to set the image quality. There are six levels.
Interval	It is to set snapshot frequency. The value ranges from 1s to 7s. Or you can set customized value. The max setup is 3600s/picture.
Copy	Click it; you can copy current channel setup to other channel(s).

5.10.1.3.3 Video Overlay

The video overlay interface is shown as in Figure 5-33.

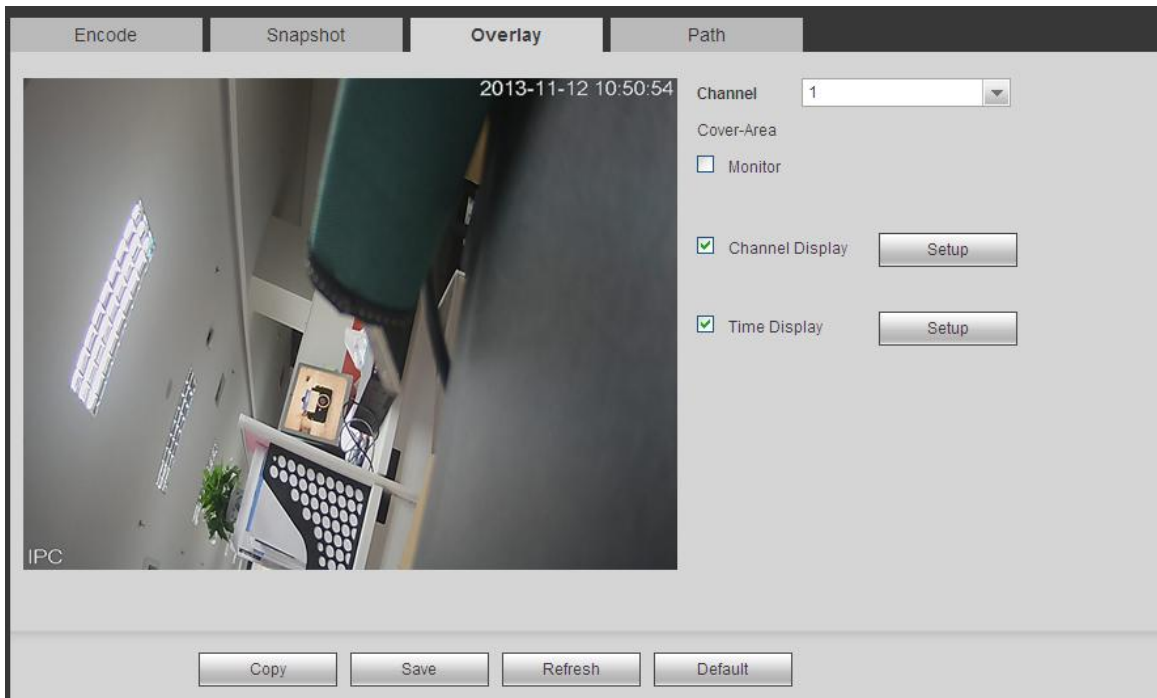



Figure 5-33

Please refer to the following sheet for detailed information.

Parameter	Function
Cover-area	Check Preview or Monitor first. Click Set button, you can privacy mask the specified video in the preview or monitor video. System max supports 4 privacy mask zones.
Time Title	You can enable this function so that system overlays time information in video window. You can use the mouse to drag the time title position. You can view time title on the live video of the WEB or the playback video.
Channel Title	You can enable this function so that system overlays channel information in video window. You can use the mouse to drag the channel title position. You can view channel title on the live video of the WEB or the playback video.

5.10.1.3.4 Path

The storage path interface is shown as in Figure 5-34.

Here you can set snap image saved path ( in the preview interface) and the record storage path



(in the preview interface).The default setup is C:\PictureDownload and C:\RecordDownload.

Please click the Save button to save current setup.

Figure 5-34

5.10.1.4 Channel Name

Here you can set channel name. See Figure 5-35.

Figure 5-35

5.10.2 Network

5.10.2.1 TCP/IP

The TCP/IP interface is shown as in Figure 5-36.

Figure 5-36

Please refer to the following sheet for detailed information.

Parameter	Function
Mode	<p>There are two modes: static mode and the DHCP mode.</p> <ul style="list-style-type: none"> ● The IP/submask/gateway are null when you select the DHCP mode to auto search the IP. ● If you select the static mode, you need to set the IP/submask/gateway manually. ● If you select the DHCP mode, you can view the

	<p>IP/submask/gateway from the DHCP.</p> <ul style="list-style-type: none"> ● If you switch from the DHCP mode to the static mode, you need to reset the IP parameters. ● Besides, IP/submask/gateway and DHCP are read-only when the PPPoE dial is OK.
Mac Address	It is to display host Mac address.
IP Version	It is to select IP version. IPV4 or IPV6. You can access the IP address of these two versions.
IP Address	Please use the keyboard to input the corresponding number to modify the IP address and then set the corresponding subnet mask and the default gateway.
Preferred DNS	DNS IP address.
Alternate DNS	Alternate DNS IP address.
For the IP address of IPv6 version, default gateway, preferred DNS and alternate DNS, the input value shall be 128-digit. It shall not be left in blank.	
LAN load	System can process the downloaded data first if you enable this function. The download speed is 1.5X or 2.0X of the normal speed.

5.10.2.2 Port

The connection interface is shown as in Figure 5-37.

PORT

Max Connection: 128 (1~128)

TCP Port: 37777 (1025~65535)

UDP Port: 37778 (1025~65535)

HTTP Port: 80 (1~65535)

HTTPS Port: 443 (1~65535) Enable

RTSP Port: 554 (1~65535)

RTSP Format: rtsp://<Username>:<Password>@<IP Address>:<Port>/cam/realmonitor?channel=1&subtype=0
channel: Channel, 1-4; subtype: Code-Stream Type, Main Stream 0, Sub Stream 1.

OK Refresh Default

Figure 5-37

Please refer to the following sheet for detailed information.

Parameter	Function
Max connection	The max client login amount (such as WEB, platform, cellphone and etc). The value ranges from 1 to 128(default).
TCP port	The default value is 37777. You can input the actual port number if necessary.
UDP port	The default value is 37778. You can input the actual port number if necessary.
HTTP port	The default value is 80. You can input the actual port number if necessary.

HTTPS	Select the Enable check box and configure the port according to your actual needs. The default value is 443. After HTTPS is enabled, HTTP will be switched to HTTPS by force to transmit data in a safer way.
RTSP port	The default value is 554.

5.10.2.3 HTTPS

In this interface, you can set to make sure the PC can successfully login via the HTTPS. It is to guarantee communication data security. The reliable and stable technology can secure the user information security and device safety. See Figure 5-38.

Note

- You need to implement server certificate again if you have changed device IP.
- You need to download root certificate if it is your first time to use HTTPS on current PC.

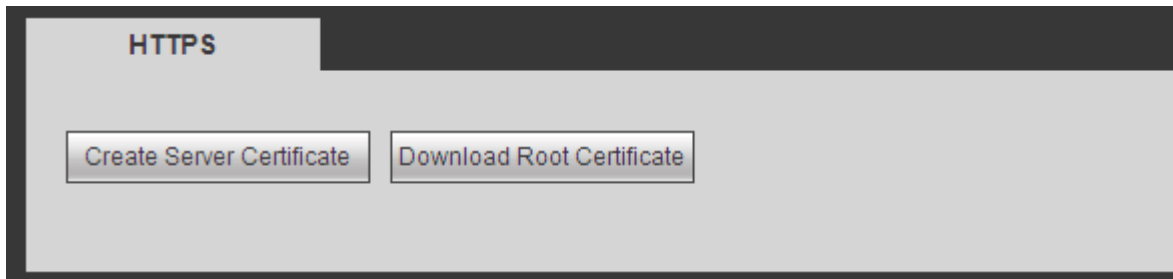
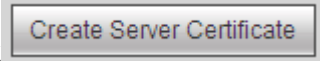

Figure 5-38

5.10.2.3.1 Create Server Certificate

If it is your first time to use this function, please follow the steps listed below.

In Figure 5-38, click  button, input country name, state name and etc. Click Create button. See Figure 5-39.

Note

Please make sure the IP or domain information is the same as your device IP or domain name.

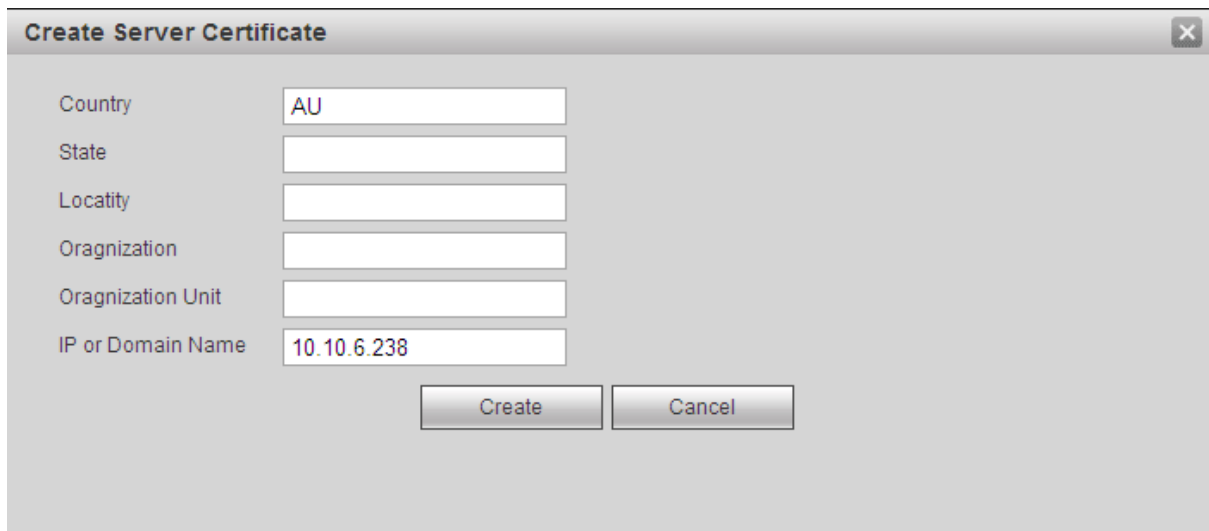

Figure 5-39

You can see the corresponding prompt. See Figure 5-40. Now the server certificate is successfully created.



Figure 5-40

5.10.2.3.2 Download Root Certificate

In Figure 5-38, click **Download Root Certificate** button, system pops up a dialogue box. See Figure 5-41.



Figure 5-41

Click Open button, you can go to the following interface. See Figure 5-42.

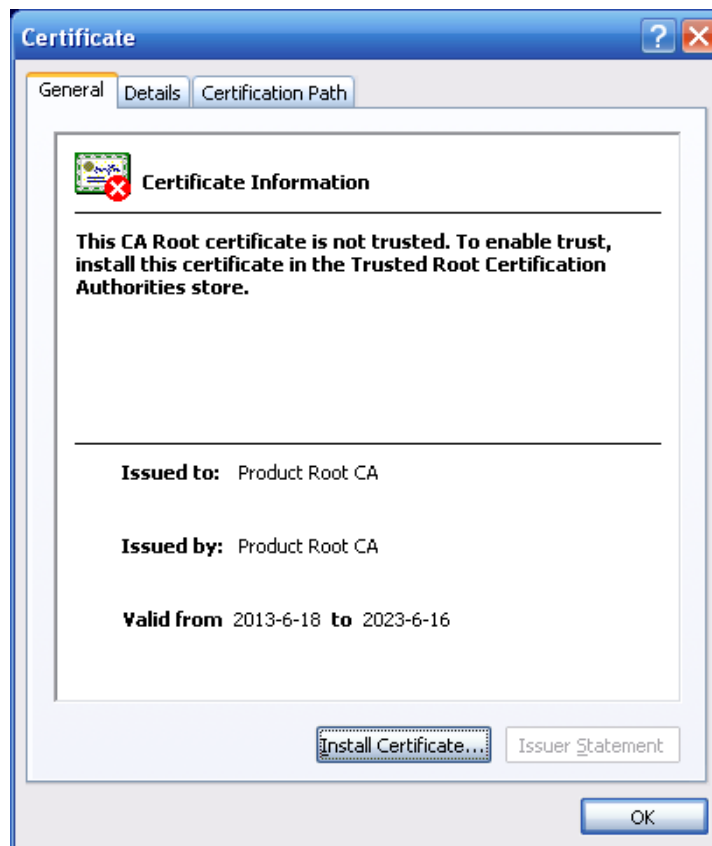

Figure 5-42

Click Install certificate button, you can go to certificate wizard. See Figure 5-43.

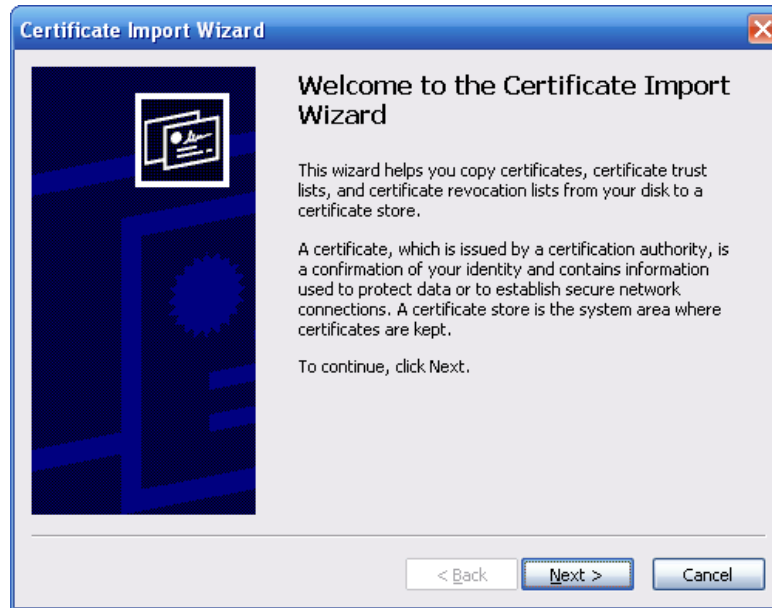

Figure 5-43

Click Next button to continue. Now you can select a location for the certificate. See Figure 5-44.

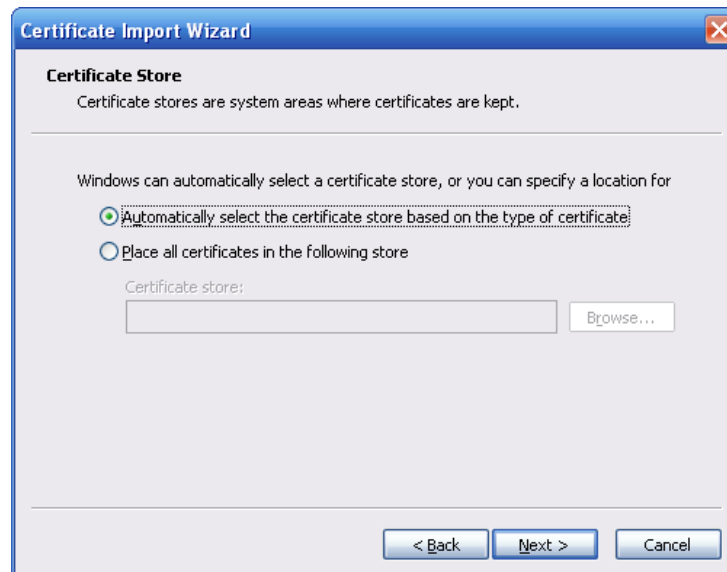

Figure 5-44

Click Next button, you can see the certificate import process is complete. See Figure 5-45.

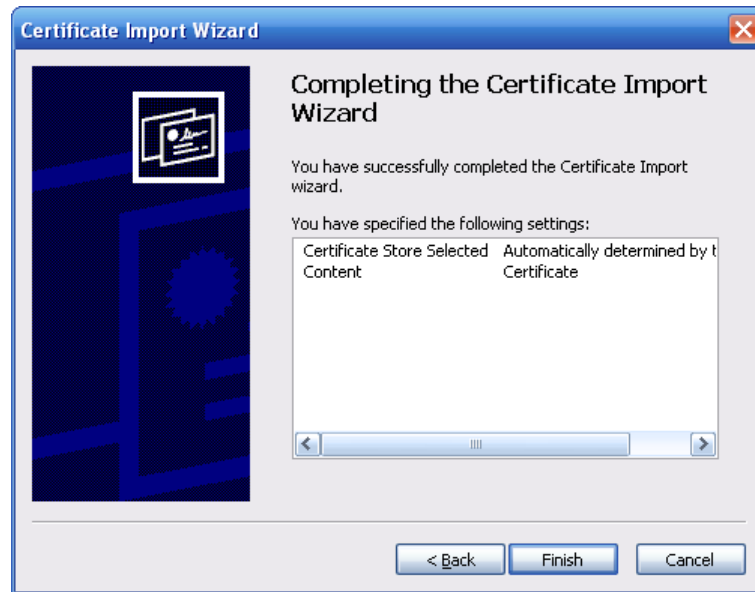

Figure 5-45

Click Finish button, you can see system pops up a security warning dialogue box. See Figure 5-46.



Figure 5-46

Click Yes button, system pops up the following dialogue box, you can see the certificate download is complete. See Figure 5-47.



Figure 5-47

5.10.2.3.3 View and Set HTTPS Port

From Setup->Network->Port, you can see the following interface. See Figure 5-48. You can see HTTPS default value is 443.

PORT

Max Connection: 128 (1~128)

TCP Port: 37777 (1025~65535)

UDP Port: 37778 (1025~65535)

HTTP Port: 80 (1~65535)

HTTPS Port: 443 (1~65535) Enable

RTSP Port: 554 (1~65535)

RTSP Format: rtsp://<Username>:<Password>@<IP Address>:<Port>/cam/realmonitor?channel=1&subtype=0
channel: Channel, 1-4; subtype: Code-Stream Type, Main Stream 0, Sub Stream 1.

OK Refresh Default

Figure 5-48

5.10.2.3.4 Login

Open the browser and then input <https://xx.xx.xx.xx:port>.

xx.xx.xx.xx: is your device IP or domain name.

Port is your HTTPS port. If you are using default HTTPS value 443, you do not need to add port information here. You can input <https://xx.xx.xx.xx> to access.

Now you can see the login interface if your setup is right.

5.10.2.4 DDNS

DDNS (Dynamic Domain Name Server) is to dynamically refresh the DNS domain name and IP address if the device IP address has changed frequently. The user can use the domain to access the device.

Preparation

Before the operation, check the DDNS type that the device supports.

- If the DDNS type is Quick DDNS. You do not need to register the domain name.
- If the DDNS is some other type, log in the website of the DDNS provider and register information like domain name.



NOTE

- After you register the device and log in the DDNS website, you can view all connected device information of the current user.
- Before you use this function, please make sure your purchased device support current function.

Step 1 Enter from main menu > Setup > Network > DDNS.

DDNS setup interface is shown as in Figure 5-49.

Figure 5-49

Step 2 Select the Enable check box.

NOTE

After enabling DDNS, the third-party server might collect your device information.

Step 3 Select the DDNS type and configure the parameters. For details, see the below table.

Parameter	Function
DDNS Type	You can select DDNS protocol from the dropdown list and then enable DDNS function.
Host IP	DDNS server IP address
Domain Name	Your self-defined domain name.
Username	The username you input to log in the server.
Password	The password you input to log in the server.
Test	<p>After the configuration, click Test and system saves the configuration and check if the domain name can be registered successfully.</p> <ul style="list-style-type: none"> ● If succeeded, go to step 4. ● If failed, check if the domain information is correct and clear the browser buffer. <p> NOTE System supports this function when DDNS type is NO-IP DDNS.</p>
Interval	The time interval to send update request. Unit: Minute.

Step 4 After setting, click Save button.

Step 5 Input full domain name on the browser and click Enter button. The setting is right if you can view device WEB interface. Otherwise, please check the parameters.

5.10.2.5 Email

The email interface is shown as in Figure 5-50.

Figure 5-50

Please refer to the following sheet for detailed information.

Parameter	Function
Enable	Please check the box here to enable email function.
SMTP Server	Input server address and then enable this function.
Port	Default value is 25. You can modify it if necessary.
Anonymity	For the server supports the anonymity function. You can auto login anonymously. You do not need to input the user name, password and the sender information.
User Name	The user name of the sender email account.
Password	The password of sender email account.
Sender	Sender email address.
Authentication (Encryption mode)	You can select SSL or none.
Subject	Input email subject here.
Attachment	System can send out the email of the snapshot picture once you check the box here.
Receiver	Input receiver email address here. Max three addresses. It supports SSL, TLS email box.
Interval	The send interval ranges from 0 to 3600 seconds. 0 means there is no interval. Please note system will not send out the email immediately when the alarm occurs. When the alarm, motion detection or the abnormality event activates the email, system sends out the email according to the interval you specified here. This function is very useful when there are too many emails activated by the abnormality events, which may result in heavy

Parameter	Function
	load for the email server.
Health mail enable	Please check the box here to enable this function.
Update period (interval)	This function allows the system to send out the test email to check the connection is OK or not. Please check the box to enable this function and then set the corresponding interval. The value ranges from 30 minutes to 1440 minutes. System can send out the email regularly as you set here.
Email test	The system will automatically sent out a email once to test the connection is OK or not .Before the email test, please save the email setup information.

5.10.2.6 Register

The register interface is shown as below. See Figure 5-51.

This function allows the device to auto register to the proxy you specified. In this way, you can use the client-end to access the NVR and etc via the proxy. Here the proxy has a switch function. In the network service, device supports the server address of IPv4 or domain.

Please follow the steps listed below to use this function.

Please set proxy server address, port, and sub-device name at the device-end. Please enable the auto register function, the device can auto register to the proxy server.

The screenshot shows a web-based configuration page titled "REGISTER". At the top left, there is a checkbox labeled "Enable". Below this, there are three input fields: "Host IP" with the value "1 . 0 . 0 . 1", "Port" with the value "8000" and a range "(1~65535)", and "Sub-device ID" with the value "0". At the bottom of the form, there are three buttons: "OK", "Refresh", and "Default".

Figure 5-51

5.10.2.7 P2P

You can use your cell phone to scan the QR code and add it to the cell phone client.

Via the SN from scanning the QR code, you can access the device in the WAN. Please refer to the P2P operation manual included in the resources CD.

The P2P interface is shown as in Figure 5-52.



Figure 5-52

Check the Enable box to enable P2P function and then click the Save button. When the Status shows Online, the P2P registration is successful.



NOTE

- P2P is enabled by default.
- To enable you to manage the device on the mobile APP, we will collect device information like IP address, MAC address, device name and device SN. The collected information is only used for remote device access.

5.10.2.8 SWITCH

When connect a network camera to the PoE port of the NVR, NVR can automatically allocate the IP address according to the specified IP segment. The network camera can automatically register to the NVR.

It is for you to set IP address, subnet mask, gateway and etc of the Switch. See Figure 5-53.



Caution

- This function is for product of PoE port.
- Do not connect switch to the PoE port, otherwise the connection may fail.
- The SWITCH function of the NVR is enabled by default. The IP segment is 10.1.1.1. Usually we recommend the default setup.
- For the camera from the third party, make sure the camera supports ONVIF and DHCP function is enabled.

Switch	
IP Address	10 . 1 . 1 . 1
Subnet Mask	255 . 255 . 255 . 0
Default Gateway	10 . 1 . 1 . 1
<input type="button" value="OK"/> <input type="button" value="Refresh"/> <input type="button" value="Default"/>	

Figure 5-53

5.10.3 Event

5.10.3.1 Video detect

5.10.3.1.1 Motion Detect

After analysis video, system can generate a video loss alarm when the detected moving signal reached the sensitivity you set here.

The motion detect interface is shown as in Figure 5-54.

Motion Detect	Video Loss	Tampering
<input checked="" type="checkbox"/> Enable	D1	
Period	<input type="button" value="Setup"/>	
Anti-dither	5	Sec.(0-600)
Region	<input type="button" value="Setup"/>	
<input checked="" type="checkbox"/> Record Channel	<input type="button" value="Setup"/>	
Post Record	10	Sec.(10~300)
<input type="checkbox"/> PTZ Activation	<input type="button" value="Setup"/>	
<input type="checkbox"/> Tour	<input type="button" value="Setup"/>	
<input type="checkbox"/> Snapshot	<input type="button" value="Setup"/>	
<input type="checkbox"/> Voice Prompts	File Name	None
<input type="checkbox"/> Show Message	<input type="checkbox"/> Send Email	<input type="checkbox"/> Buzzer <input type="checkbox"/> Log
<input type="button" value="Copy"/> <input type="button" value="OK"/> <input type="button" value="Refresh"/> <input type="button" value="Default"/>		

Figure 5-54

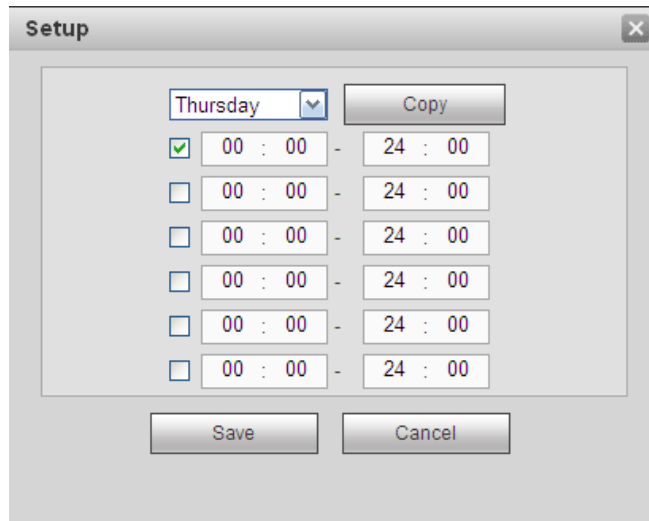

Figure 5-55

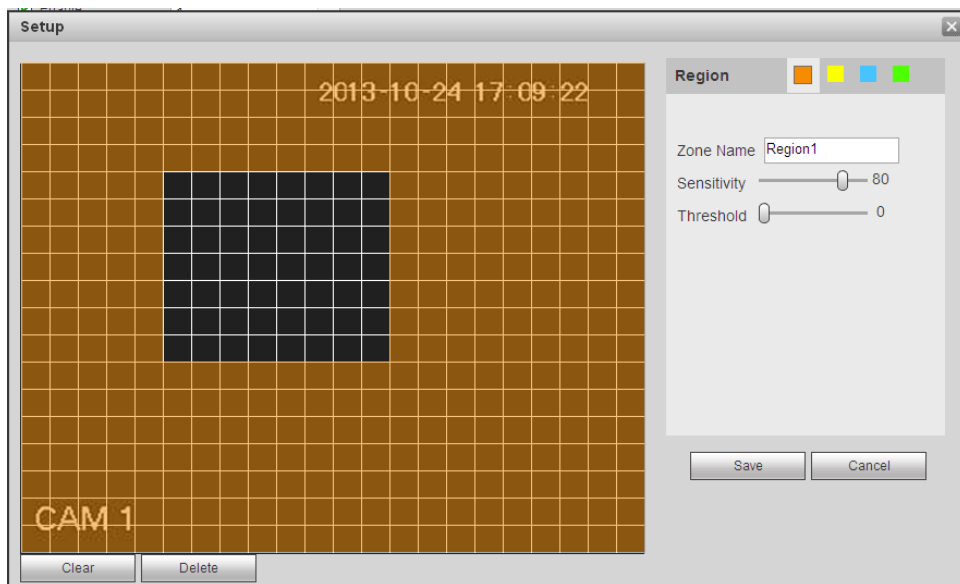

Figure 5-56

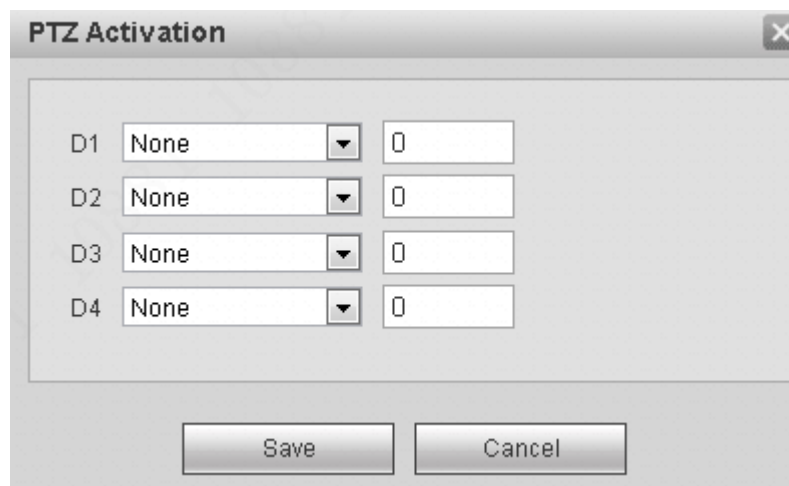

Figure 5-57

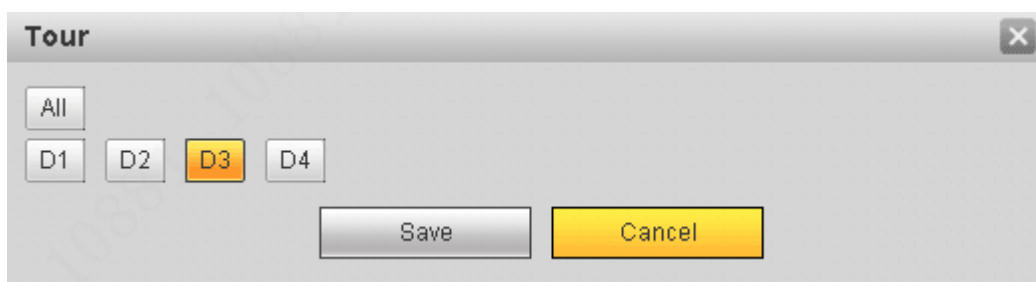

Figure 5-58

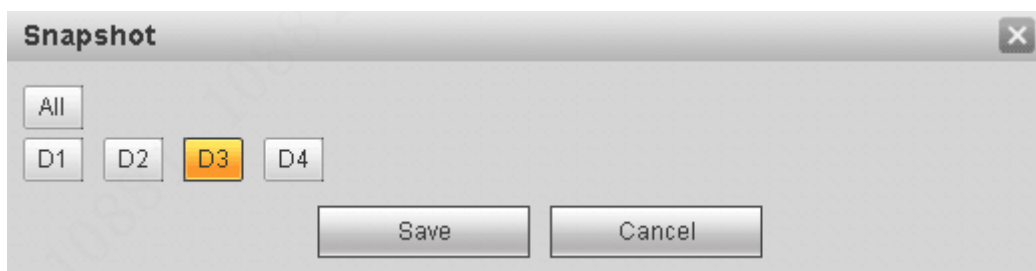

Figure 5-59

Please refer to the following sheet for detailed information.

Parameter	Function
Enable	You need to check the box to enable motion detection function. Please select a channel from the dropdown list.
Period	Motion detection function becomes activated in the specified periods. See Figure 5-55. There are six periods in one day. Please draw a circle to enable corresponding period. Click OK button, system goes back to motion detection interface, please click save button to exit.
Anti-dither	System only memorizes one event during the anti-dither period. The value ranges from 5s to 600s.
Sensitivity	There are six levels. The sixth level has the highest sensitivity.
Region	If you select motion detection type, you can click this button to set motion detection zone. The interface is shown as in Figure 5-56. Here you can set motion detection zone. There are four zones for you to set. Please select a zone first and then left drag the mouse to select a zone. The corresponding color zone displays different detection zone. You can click Fn button to switch between the arm mode and disarm mode. In arm mode, you can click the direction buttons to move the green rectangle to set the motion detection zone. After you completed the setup, please click ENTER button to exit current setup. Do remember click save button to save current setup. If you click ESC button to exit the region setup interface system will not save your zone setup.
Record channel	System auto activates motion detection channel(s) to record once an alarm occurs. Please note you need to set motion detect record period and go to Storage-> Schedule to set current channel as schedule record.

Parameter	Function
Record Delay	System can delay the record for specified time after alarm ended. The value ranges from 10s to 300s.
Latch	System can delay the alarm output for specified time after an alarm ended. The value ranges from 1s to 300s.
Show message	System can pop up a message to alarm you in the local host screen if you enabled this function.
Tour	You need to click setup button to select tour channel. System begins 1-wiindow or multiple-window tour display among the channel(s) you set to record when an alarm occurs. See Figure 5-58.
PTZ Activation	Here you can set PTZ movement when alarm occurs. Such as go to preset X. See Figure 5-57.
Snapshot	Click setup button to select snapshot channel. See Figure 5-59.

5.10.3.1.1 Video Loss

The video loss interface is shown as in Figure 5-60.

Please note video loss does not support anti-dither, sensitivity, region setup. For rest setups, please refer to chapter 5.10.3.1.1 motion detect for detailed information.

Figure 5-60

5.10.3.1.2 Tampering

The tampering interface is shown as in Figure 5-61.

After analysis video, system can generate a tampering alarm when the detected moving signal reached the sensitivity you set here.

For detailed setups, please refer to chapter 5.10.3.1.1 motion detect for detailed information.

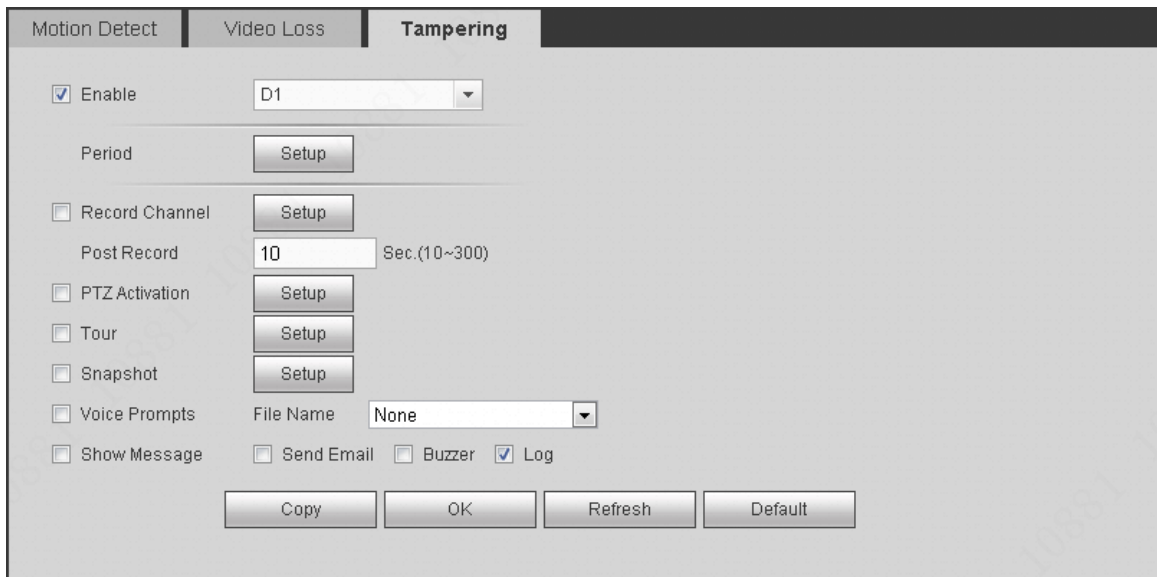

Figure 5-61

5.10.3.2 Alarm

Before operation, please make sure you have properly connected alarm devices such as buzzer. The input mode includes local alarm and network alarm.

5.10.3.2.1 IPC External Alarm

The IPC external alarm interface is shown as in Figure 5-62. Network alarm refers to the alarm signal from the network.

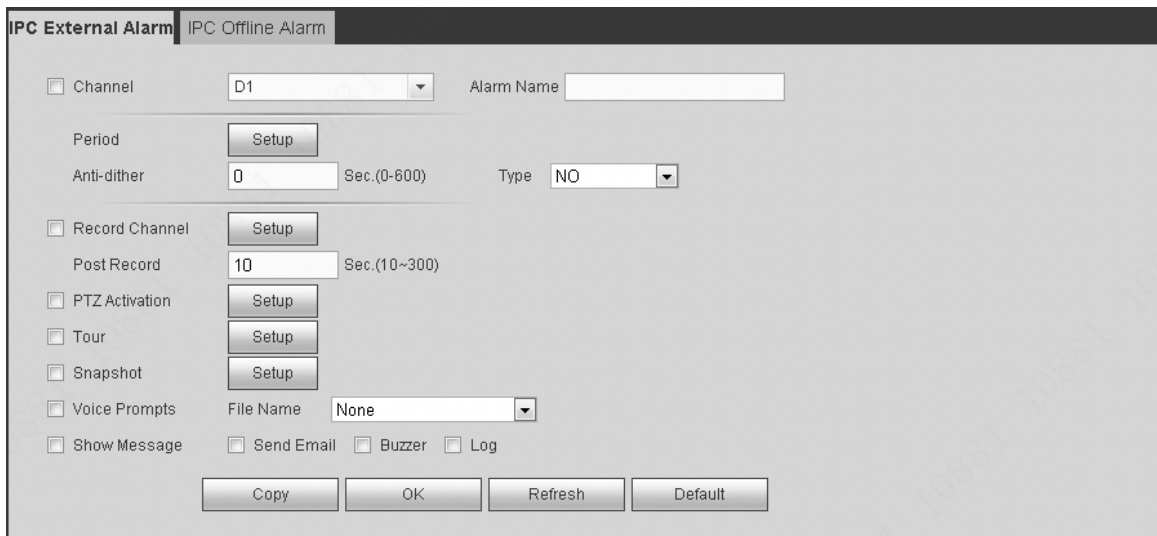

Figure 5-62

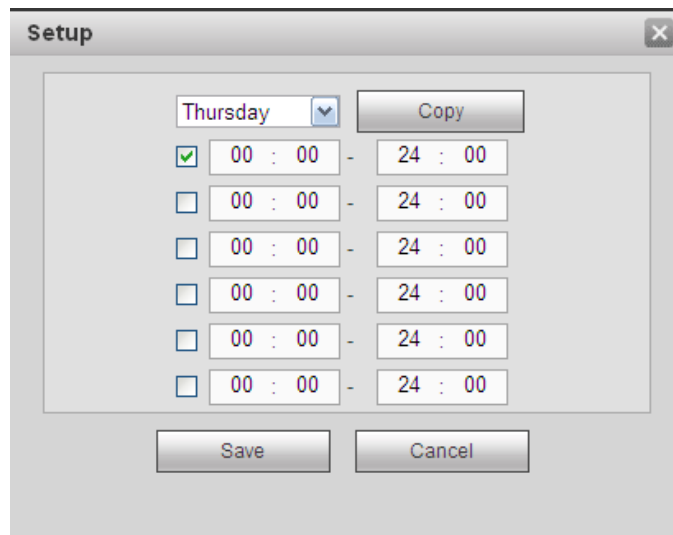

Figure 5-63

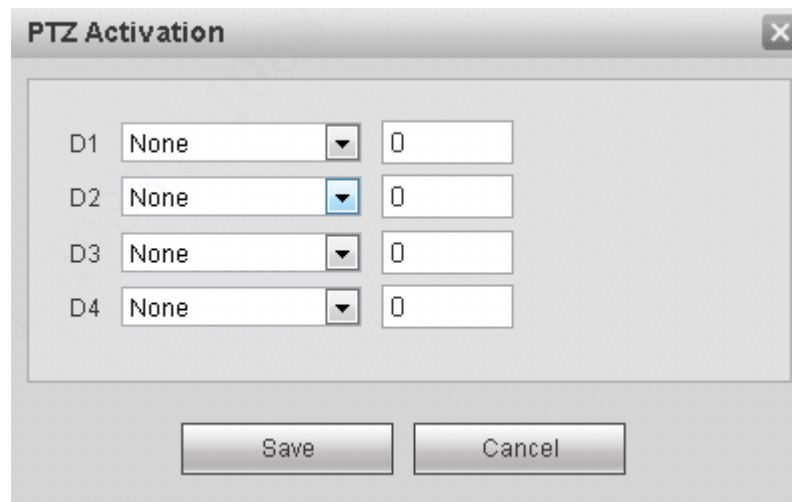

Figure 5-64

Please refer to the following sheet for detailed information.

Parameter	Function
Enable	You need to check the box to enable this function. Please select a channel from the dropdown list.
Period	This function becomes activated in the specified periods. There are six periods in one day. Please draw a circle to enable corresponding period. Select date. If you do not select, current setup applies to today only. You can select all week column to apply to the whole week. Click OK button, system goes back to local alarm interface, please click save button to exit.
Anti-dither	System only memorizes one event during the anti-dither period. The value ranges from 5s to 600s.
Sensor type	There are two options: NO/NC.

Parameter	Function
Record channel	System auto activates motion detection channel(s) to record once an alarm occurs. Please note you need to set alarm record period and go to Storage-> Schedule to set current channel as schedule record.
Record Delay	System can delay the record for specified time after alarm ended. The value ranges from 10s to 300s.
Latch	System can delay the alarm output for specified time after an alarm ended. The value ranges from 1s to 300s.
Show message	System can pop up a message to alarm you in the local host screen if you enabled this function.
Tour	You need to click setup button to select tour channel. System begins 1-window or multiple-window tour display among the channel(s) you set to record when an alarm occurs. See Figure 5-58.
PTZ Activation	Here you can set PTZ movement when alarm occurs. Such as go to preset X. See Figure 5-64.
Snapshot	Click setup button to select snapshot channel. See Figure 5-59.

5.10.3.2.2 IPC Offline Alarm

The IPC offline alarm interface is shown as in Figure 5-65.

System can generate an alarm once the network camera is offline. For setup information, please refer to chapter 5.10.3.2.1.

Figure 5-65

5.10.3.3 Abnormality

From main menu->Setup->Event->Abnormality, it includes four types: HDD/Network/User/Device. See Figure 5-66 through Figure 5-68.

Figure 5-66

Figure 5-67

Figure 5-68

Please refer to the following sheet for detailed information.

Parameter	Function
Event Type	<p>The abnormal events include:</p> <ul style="list-style-type: none"> ● HDD: No HDD, HDD error, disk no space; ● Network: Net disconnection, IP conflict, MAC conflict. ● User: Illegal login. <p>You can set one or more items here.</p> <ul style="list-style-type: none"> ● Less than: You can set the minimum percentage value here. The device can generate an alarm when capacity is not sufficient. This

Parameter	Function
	item is for disk no space type only.
Enable	Check the box here to enable selected function.
Latch	The alarm output can delay for the specified time after an alarm stops. The value ranges from 0s to 300s. The default setup is 10 seconds. The 0 second means there is no delaying time.
Attempt(s)	It is to set login attempt times. Once the login attempt exceeds the threshold you set here, current account will be locked. This function is for illegal login only.
Lock time	It is to set account lock time once its login attempt has exceeded the threshold you set. This function is for illegal login only.
Show message	System can pop up a message to alarm you in the local host screen if you enabled this function.
Log	Check the box here, system can record the network event alarm log.

5.10.4 Storage

5.10.4.1 Basic

It is to manage HDD storage space.

Step 4 From main menu->Setup->Storage->Basic.

Enter Basic interface. See Figure 5-69.

The screenshot shows the 'BASIC' configuration page for storage. It includes the following fields and controls:

- HDD Full:** A dropdown menu currently set to 'Overwrite'.
- Pack Duration:** A text input field containing '60' followed by the label 'Minute'.
- Auto Delete Old Files:** A dropdown menu currently set to 'Never'.
- Buttons:** Three buttons labeled 'Save', 'Refresh', and 'Default' are positioned at the bottom of the form.

Figure 5-69

Step 5 Set parameters.

Parameter	Function
HDD full	It is to select working mode when hard disk is full. There are two options: stop recording or overwrite.
Pack duration	It is to specify record duration. The max value is 120 minutes.
Auto delete old files	<ul style="list-style-type: none"> ● Never: Do not auto delete old files. ● Customized: input customized period here, system can auto delete corresponding old files

5.10.4.2 Schedule

In this interface, you can add or remove the schedule record setup. See Figure 5-70.

There are four record modes: general (auto), motion detect, alarm and MD&alarm. There are six periods

in one day.

You can view the current time period setup from the color bar.

- Green color stands for the general record/snapshot.
- Yellow color stands for the motion detect record/snapshot.
- Red color stands for the alarm record/snapshot.
- Blue color stands for MD&alarm record/snapshot.

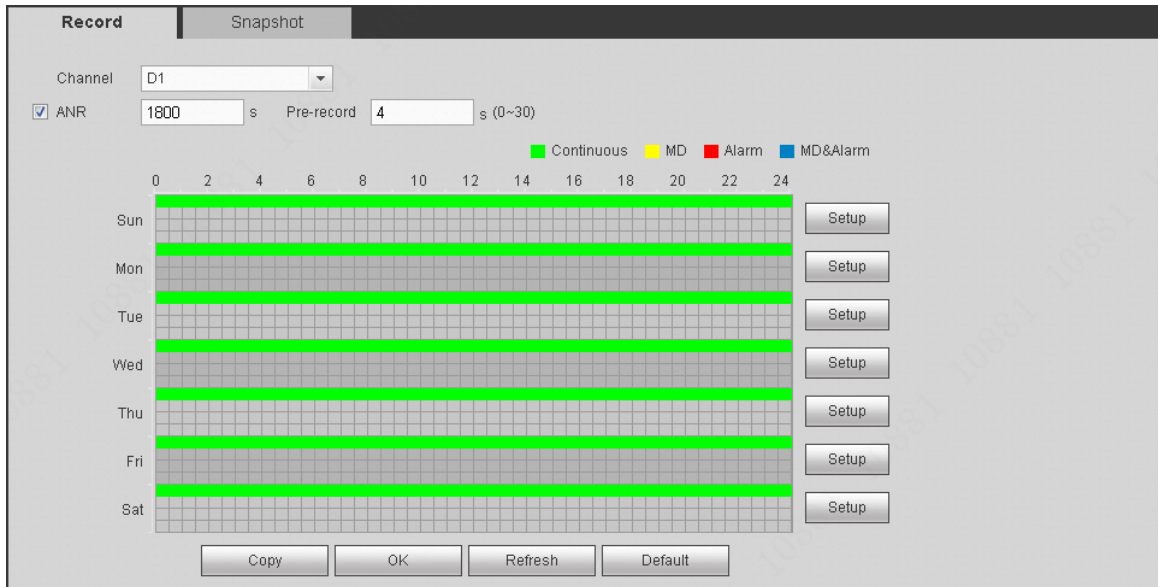

Figure 5-70

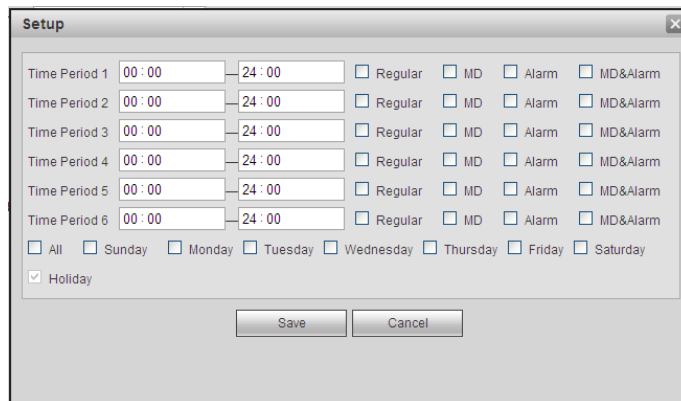

Figure 5-71

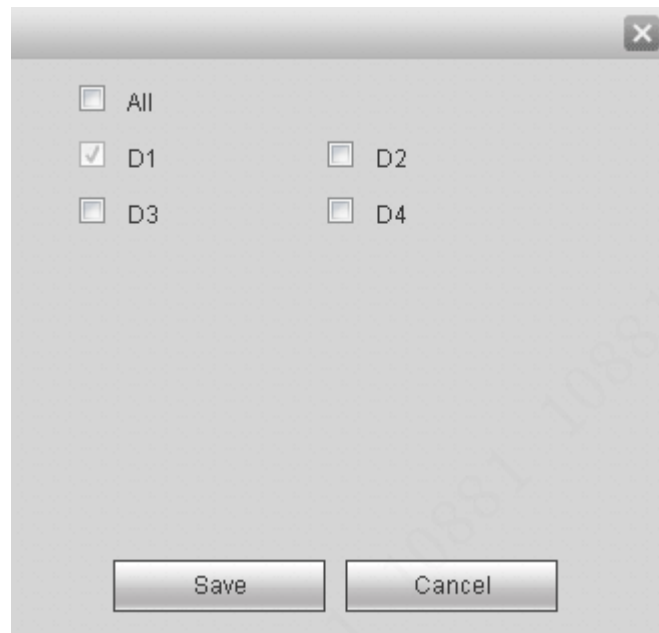

Figure 5-72

Please refer to the following sheet for detailed information.

Parameter	Function
Channel	Please select a channel from the dropdown list.
Pre-record	Please input pre-record time here. The value ranges from 0 to 30.
Redundancy	Check the box here to enable redundancy function. Please note this function is null if there is only one HDD.
Snapshot	Check the box here to enable snapshot function.
Holiday	Check the box here to enable holiday function.
Setup	Click the Setup button, you can set record period. See Figure 5-71. There are six periods in one day. If you do not check the date at the bottom of the interface, current setup is for today only. Please click Save button and then exit.
Copy	Copy function allows you to copy one channel setup to another. After setting in channel, click Copy button, you can go to interface Figure 5-72. You can see current channel name is grey such as channel 1. Now you can select the channel you want to paste such as channel 5/6/7. If you want to save current setup of channel 1 to all channels, you can click the first box "ALL". Click the OK button to save current copy setup. Click the OK button in the Encode interface, the copy function succeeded.

5.10.4.3 HDD Manager

5.10.4.3.1 Local Storage

The local interface is shown as in Figure 5-73. Here you can see HDD information. You can also operate the read-only, read-write, redundancy (if there are more than on HDD) and format operation.

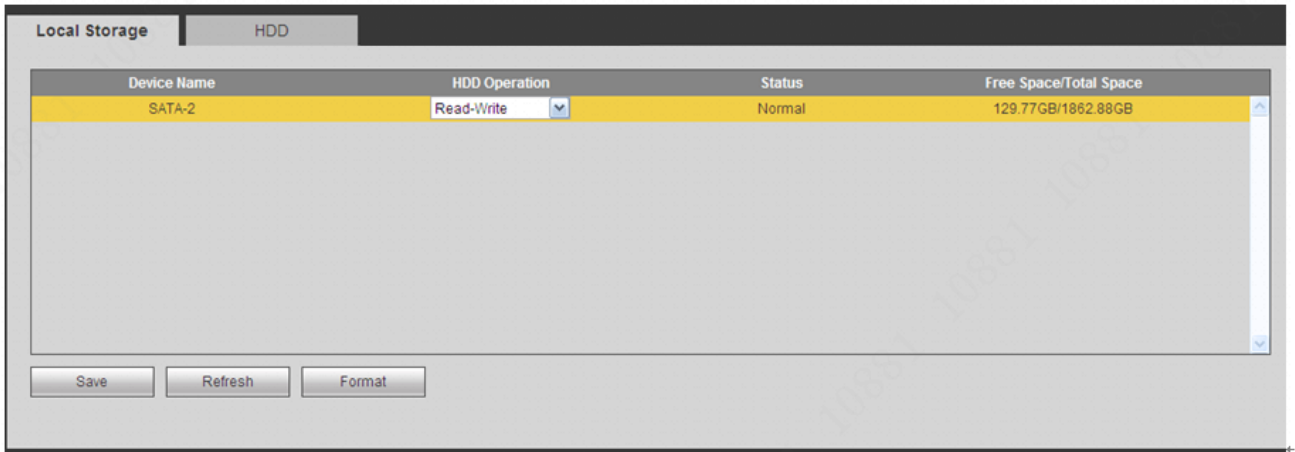

Figure 5-73

5.10.4.3.2 HDD

The HDD interface is to set HDD group. See Figure 5-74.

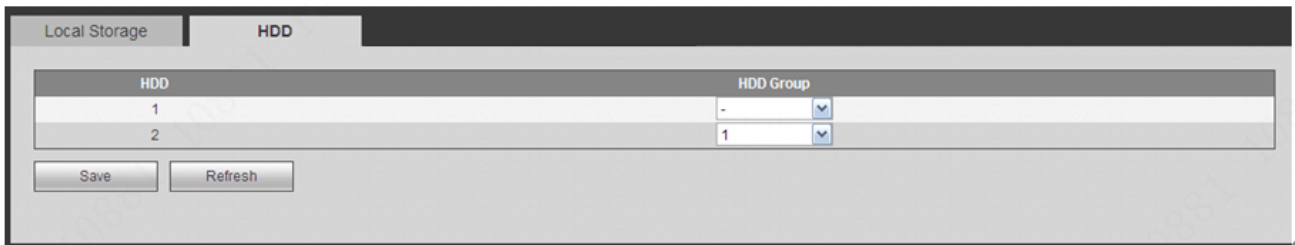

Figure 5-74

5.10.4.4 Record Control

The interface is shown as in Figure 5-75.

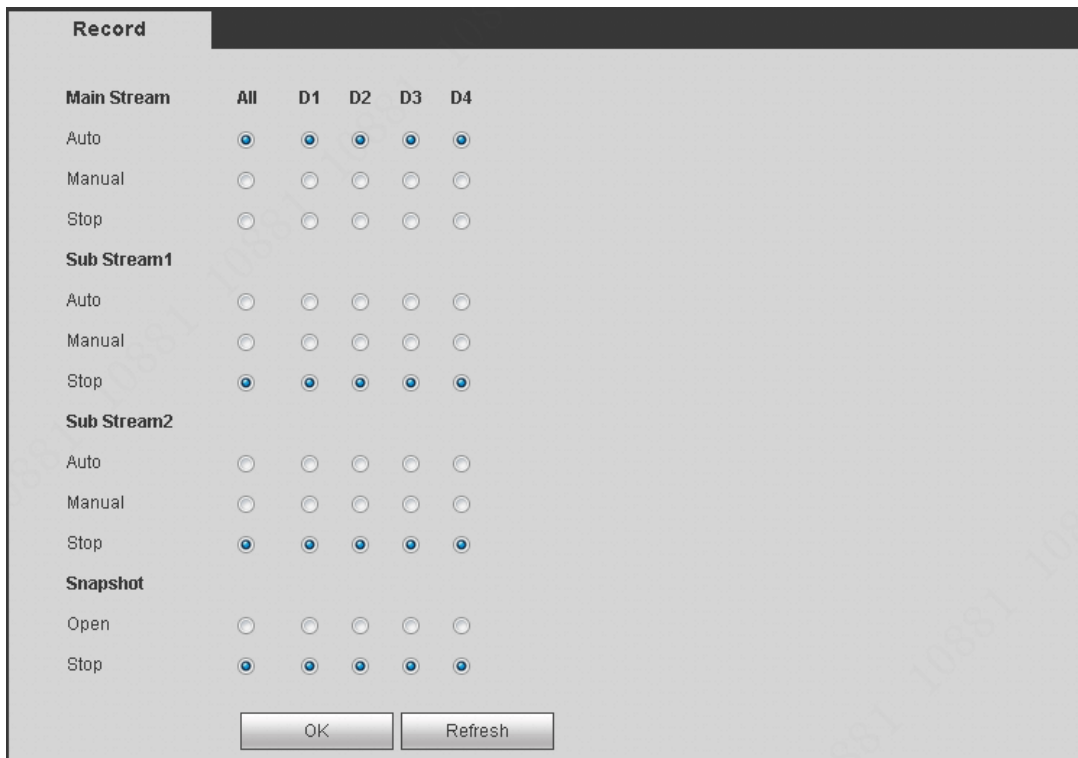

Figure 5-75

Please refer to the following sheet for detailed information.

Parameter	Function
Channel	Here you can view channel number. The number displayed here is the max channel amount of your device.
Status	There are three statuses: schedule, manual and stop.
Schedule	System enables auto record function as you set in record schedule setup (general, motion detect and alarm).
Manual	It has the highest priority. Enable corresponding channel to record no matter what period applied in the record setup.
Stop	Stop current channel record no matter what period applied in the record setup.
Start all/ stop all	Check the corresponding All button, you can enable or disable all channels record.

5.10.5 System

5.10.5.1 General

The general interface includes general, date/time and holiday setup.

5.10.5.1.1 General

The general interface is shown as in Figure 5-76.

The screenshot shows a software interface with three tabs: 'General', 'Date&Time', and 'Holiday'. The 'General' tab is active. It contains the following fields and controls:

- Device Name:** A text input field containing 'NVR'.
- Device No.:** A text input field containing '8'.
- Language:** A dropdown menu currently set to 'ENGLISH'.
- IPC Time Sync:** A checked checkbox followed by a text input field containing '24' and the label 'Hour'.

At the bottom of the form are three buttons: 'OK', 'Refresh', and 'Default'.

Figure 5-76

Please refer to the following sheet for detailed information.

Parameter	Function
Device ID	It is to set device name.
Device No.	It is device channel number.
Language	You can select the language from the dropdown list. Please note the device needs to reboot to get the modification activated.
IPC Time Sync	You can input an interval here to synchronize the DVR time and IPC time.

5.10.5.1.2 Date and time

The date and time interface is shown as in Figure 5-77

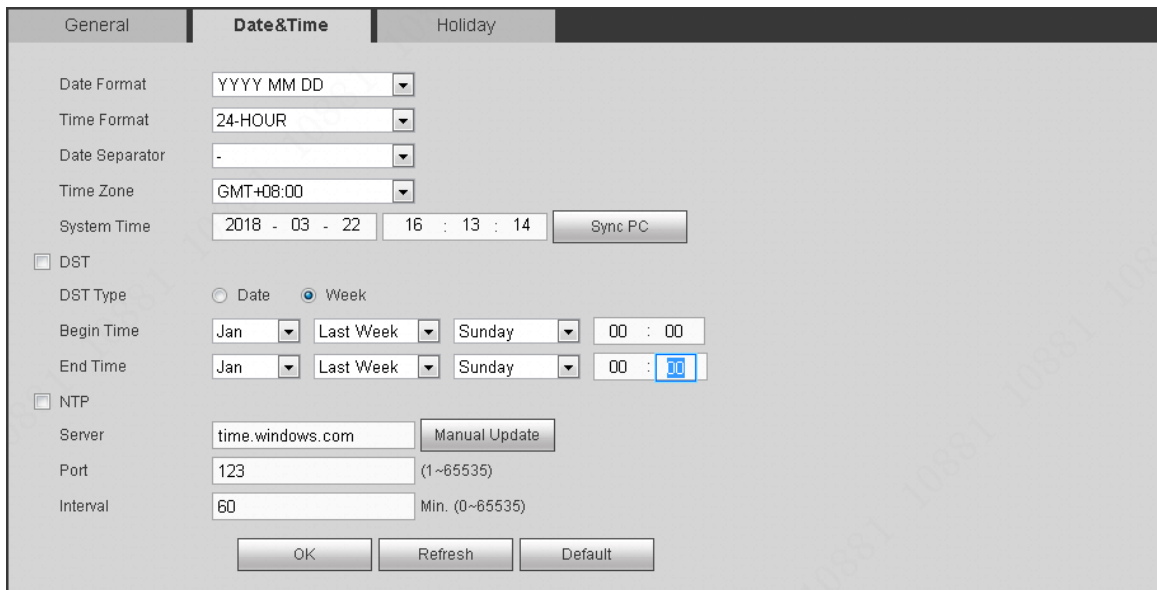

Figure 5-77

Please refer to the following sheet for detailed information.

Parameter	Function
Date format	Here you can select date format from the dropdown list.
Time Format	There are two options: 24-H and 12-H.
Time zone	The time zone of the device.
System time	It is to set system time. It becomes valid after you set.
Sync PC	You can click this button to save the system time as your PC current time.
DST	Here you can set day night save time begin time and end time. You can set according to the date format or according to the week format.
NTP	You can check the box to enable NTP function.
NTP server	You can set the time server address.
Port	It is to set the time server port.
Interval	It is to set the sync periods between the device and the time server.

5.10.5.1.3 Holiday Setup

Holiday setup interface is shown as in Figure 5-78.

Here you can click Add holidays box to add a new holiday and then click Save button to save.



Figure 5-78

5.10.5.2 Display

Display interface includes GUI, TV adjust, Tour and Customized split.

5.10.5.2.1 Display

Here you can set background color and transparency level. See Figure 5-79.

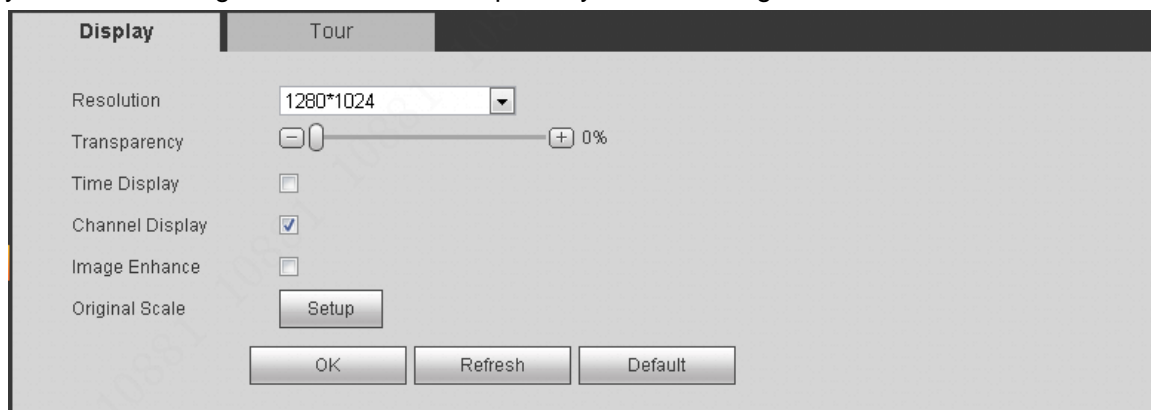

Figure 5-79

Please refer to the following sheet for detailed information.

Parameter	Function
Resolution	There are four options: 1920×1080, 1280×1024(default), 1280×720, 1024×768. Please note the system needs to reboot to activate current setup.
Color mode	Please select from the dropdown list.
Transparency	Here is for you to adjust transparency. The value ranges from 128 to 255.
Time title/channel title	Check the box here, you can view system time and channel number on the monitor video.
Image enhance	Check the box; you can optimize the margin of the preview video.
Startup wizard	Once you check the box here, system will go to the startup wizard directly when the system restarts the next time. Otherwise, it will go to the login interface.
Navigation bar	Check the box here, system displays the navigation bar on the interface.
Original scale	Click the Set button to select a channel, it can restore original scale.
Auto logout	Here is for you to set auto logout interval once login user remains

	inactive for a specified time. Value ranges from 0 to 60 minutes. 0 means there is no standby time. After the auto logout, the user needs to input user name and password to login again.
--	---

5.10.5.2.2 Tour

The tour interface is shown as in Figure 5-80. Here you can set tour interval, split mode, motion detect tour and alarm tour mode.

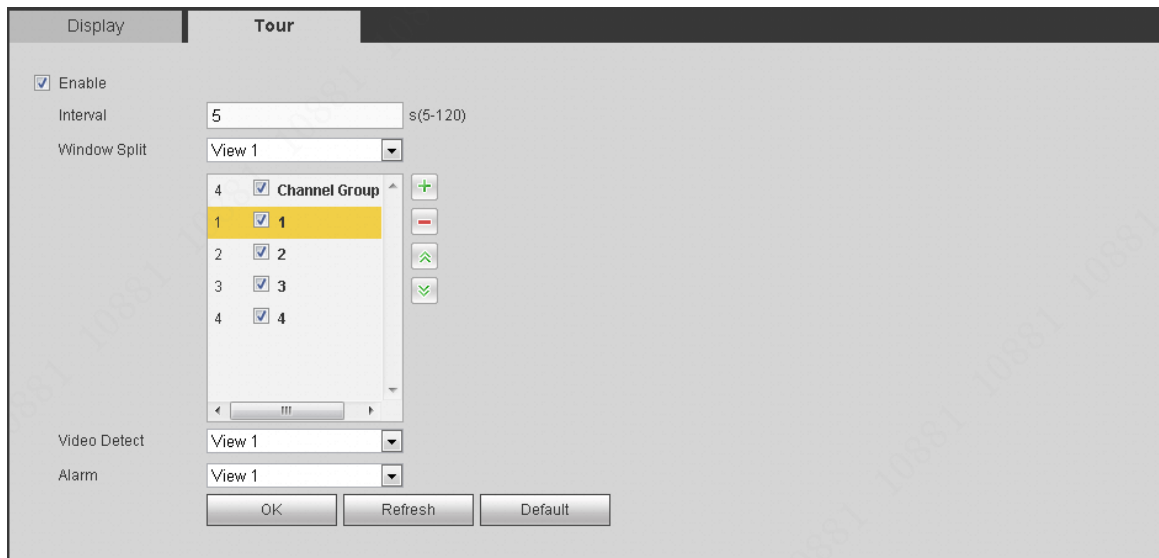

Figure 5-80

Please refer to the following sheet for detailed information.

Parameter	Function
Enable tour	Check the box here to enable tour function.
Interval	Here is for you to adjust transparency. The value ranges from 5 to 120s. The default setup is 5s.
Split	Here you can set window mode and channel group. System can support 1/4/8/9/16/25/36-window according to device channel amount.
Motion tour/Alarm tour	Here you can set motion detect tour/alarm tour window mode. System supports 1/8-window now.

5.10.5.3 Voice

The audio function is to manage audio files and set schedule play function. It is to realize audio broadcast activation function.

5.10.5.3.1 File List

From main menu->Setup->System->Voice->File list, here you can add audio file, or delete audio file. See Figure 5-81.

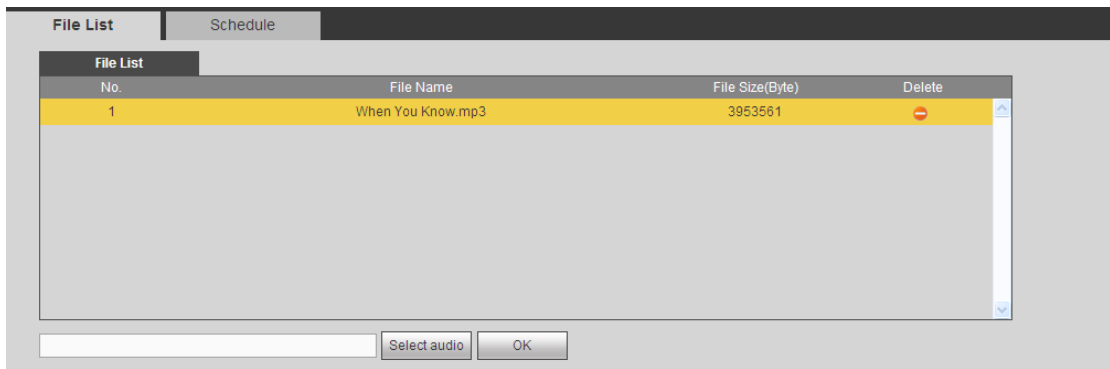

Figure 5-81

Click Add button, you can add audio file and import the audio file via the local computer. See Figure 5-82.

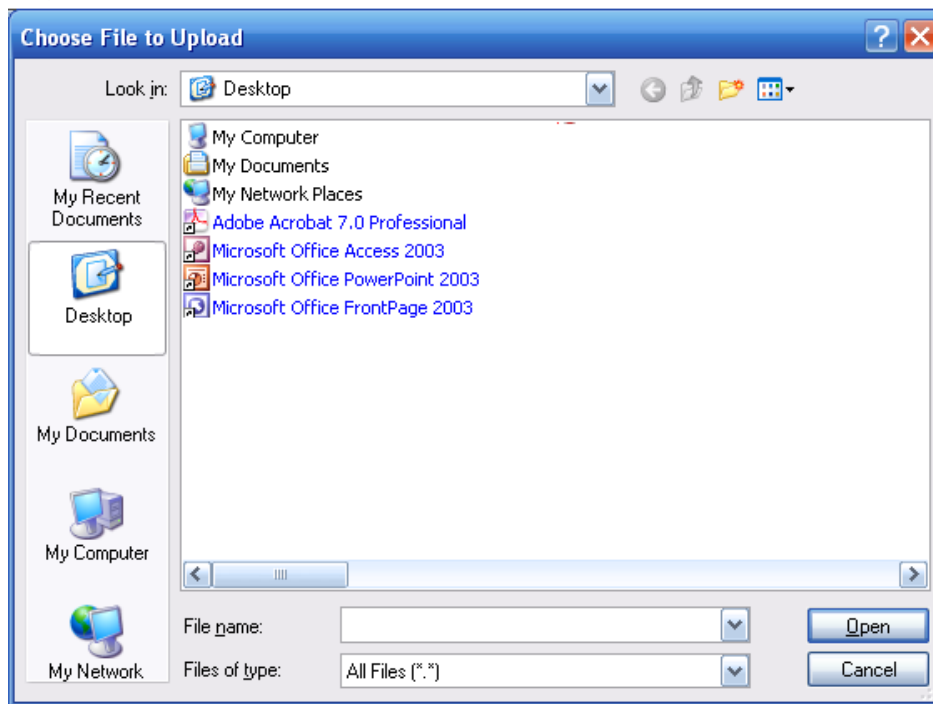

Figure 5-82

5.10.5.3.2 Schedule

It is to set schedule broadcast function. You can play the different audio files in the specified periods. From main menu->Setup->System->Voice->.Schedule, you can see the following interface. See Figure 5-83.

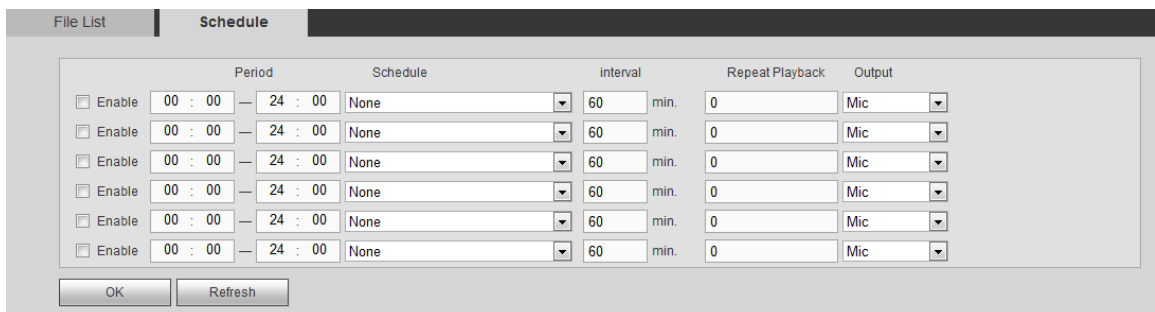

Figure 5-83

Please refer to the following sheet for detailed information.

Parameter	Function
Period	There are six periods. Check the box to enable current setup.
Repeat	It is to set audio file repeat times in the specified period.
Interval	It is the audio file repeated interval in the specified period.
Output port	There are two options: MIC (default)/audio. When reuse the MIC port and bidirectional talk port, the bidirectional port has the higher priority. Please note some series product does not support audio function.



Note

- The audio file end time depends on the audio file size and the interval setup.
- Priority: Bidirectional talk>Event trigger alarm>Trial listening>Audio schedule broadcast.

5.10.5.4 Account



Note

- For the user name, the string max length is 31-byte, and for the user group, the string max length is 15-byte. The user name can only contain English letters, numbers and “_”、“@”、“.”.
- The default user amount is 64 and the default group amount is 20. System account adopts two-level management: group and user. The user authorities shall be smaller than group authorities (The **admin** user authorities are set by default).
- For group or user management, there are two levels: admin and user. The user name shall be unique and one user shall only belong to one group.

5.10.5.4.1 User name

From main menu->Setup->System->Account->Account, enter account interface. See Figure 5-84.

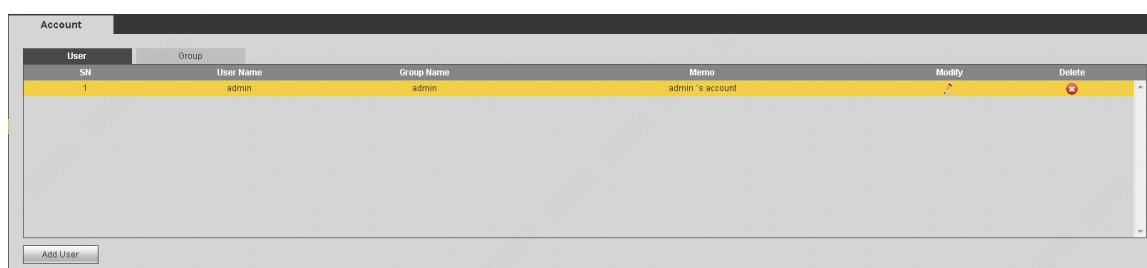

Figure 5-84

Add user

It is to add a name to group and set the user rights.

Step 1 Click Add user button.

Enter add user interface. See Figure 5-85.

Step 2 Here you can input the user name and password and then select one group for current user.

Figure 5-85

Step 3 Click Save to complete the setup.

 **Note**

Please note the user rights shall not exceed the group right setup. For convenient setup, please make sure the general user has the lower rights setup than the admin.

Modify user

It is to modify the user property, belonging group, password and rights. See Figure 5-86.

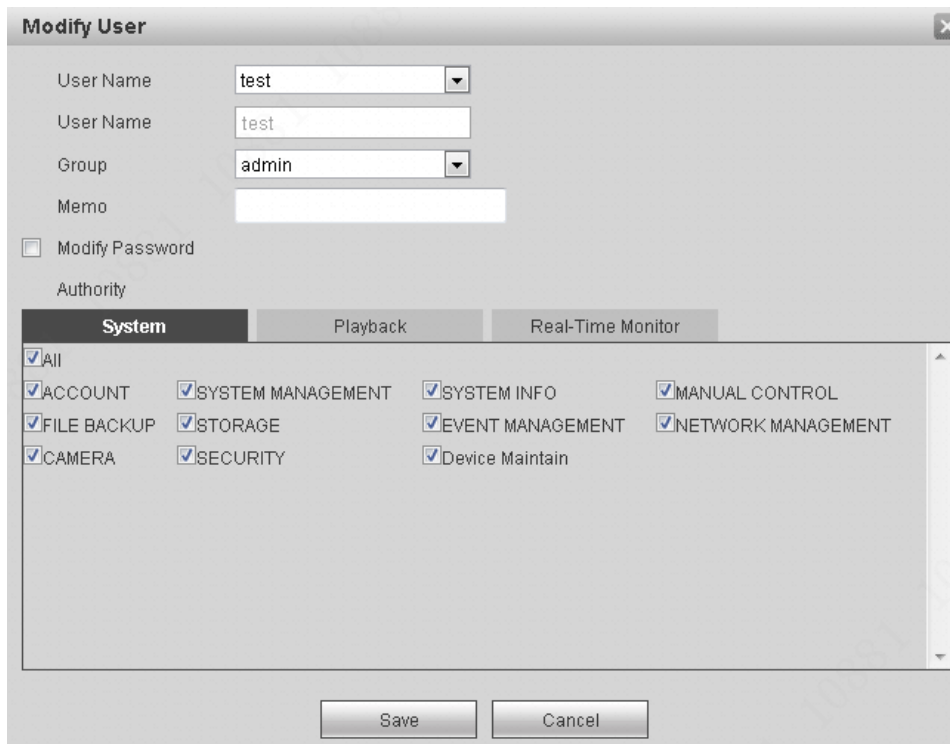

Figure 5-86

 **Note**

For admin, you can change the email information. See Figure 5-87.

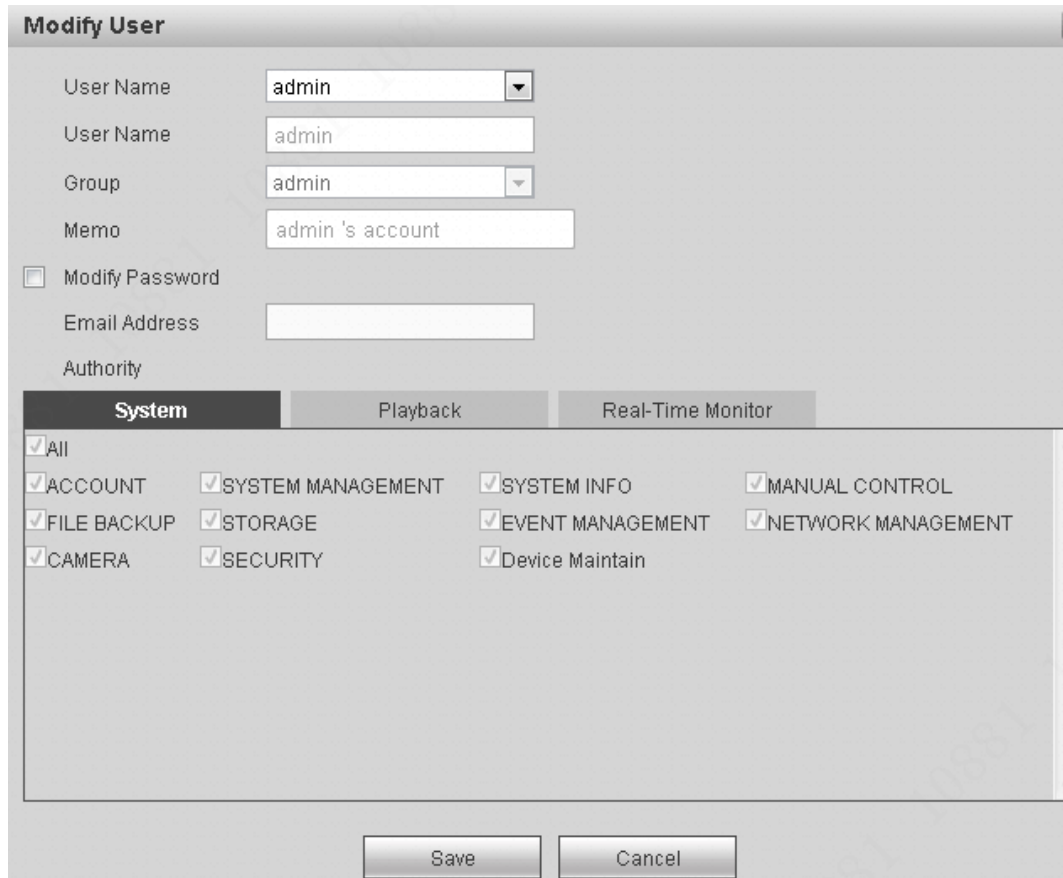

Figure 5-87

Modify password

It is to modify the user password.

Step 1 In Modify user interface, click Modify password box. See Figure 5-88.



Figure 5-88

Step 2 Input old password, and then input new password and confirm.

Step 3 Click Save button.



Note

The password ranges from 8 to 32 digitals. It can contain letters, numbers and special characters (excluding “”, “”, “”, “:”, “&”). The password shall contain at least two categories. Usually we recommend the strong password.



WARNING

STRONG PASSWORD RECOMMENDED-For your device own safety, please create a strong password of your own choosing. We also recommend you change your password periodically especially in the high security system.

5.10.5.4.2 Group

It is to add/remove group, modify group password and etc.

From main menu->Setup->System->Account->Account.

Click Group tab, the interface is shown as in Figure 5-89.

User		Group		
SN	Group Name	Memo	Modify	Delete
1	admin	administrator group		
2	user	user group		

Add Group

Figure 5-89

Add group

It is to add group and set its corresponding rights.

Step 1 Click Add group button. Enter add group interface. See Figure 5-90.

Add Group

Group Name

Memo

Authority

System

Playback

Real-Time Monitor

All

ACCOUNT

SYSTEM MANAGEMENT

SYSTEM INFO

MANUAL CONTROL

STORAGE

EVENT MANAGEMENT

NETWORK MANAGEMENT

CAMERA

SECURITY

FILE BACKUP

Device Maintain

Figure 5-90

Step 2 Input the group name and then check the box to select the corresponding rights. It includes: system, playback, and monitor.

Step 3 Click Save button.

Modify group

Step 1 Select a group and then click . See Figure 5-91.

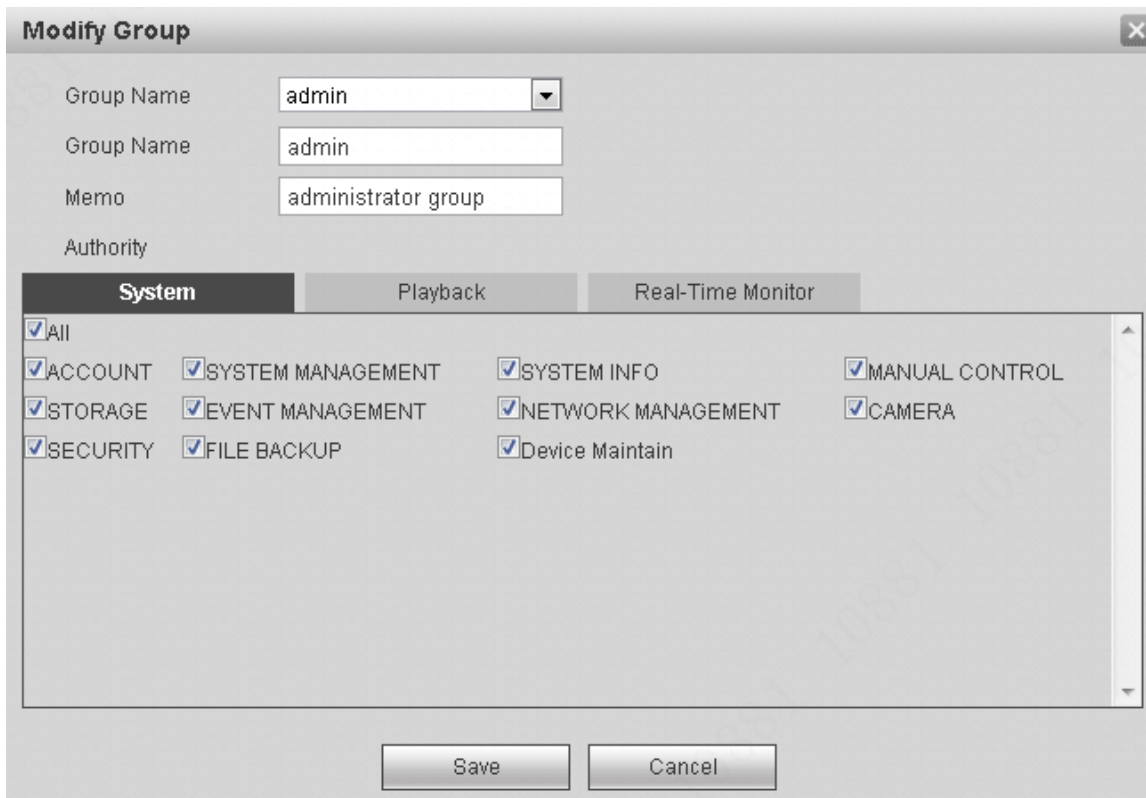

Figure 5-91

Step 2 Change corresponding information and then click Save button.

5.10.5.5 Security

5.10.5.5.1 IP filter

To enhance device network security and protect device data, please set the access right of the IP host (IP host here refers to the IP PC or the server). After you enabled trusted sites function, only the IP listed below can access current DVR.

If you enable blocked sites function, the following listed IP addresses cannot access current DVR.

Step 1 From main menu->Setting->System->Security.

Enter security interface. See Figure 5-92.

Step 2 Check the Enable box.

Select trusted sites/block sites.

- Enable trusted site function and then add the whitelist.
- Enable blocked site function and then add the blacklist.

Step 3 Set parameters.

- Start address/end address: Select one type from the dropdown list, you can input IP address in the start address and end address. Now you can click Add IP address or Add IP section to add. System supports max 64 IP addresses.
 - a) For the newly added IP address, it is in enable status by default. Remove the \checkmark before the item, and then current item is not in the list.
 - b) System max supports 64 items.
 - c) Address column supports IPv4 or IPv6 format. If it is IPv6 address, system can optimize it. For example, system can optimize aa:0000: 00: 00aa: 00aa: 00aa: 00aa: 00aa as aa:: aa: aa: aa: aa: aa: aa.

- d) System automatically removes space if there is any space before or after the newly added IP address.
- e) System only checks start address if you add IP address. System check start address and end address if you add IP section and the end address shall be larger than the start address.
- f) System may check newly added IP address exists or not. System does not add if input IP address does not exist.
- Delete: Click it to remove specified item.
- Edit: Click it to edit start address and end address. See Figure 5-93. System can check the IP address validity after the edit operation and implement IPv6 optimization.
- Default: Click it to restore default setup. In this case, the trusted sites and blocked sites are both null.

Step 4 Click Save to complete setup.

- If you enabled trusted sites, only the IP in the trusted sites list can access the device.
- If you enabled blocked sites, the IP in the blocked sites cannot access the device.



Figure 5-92

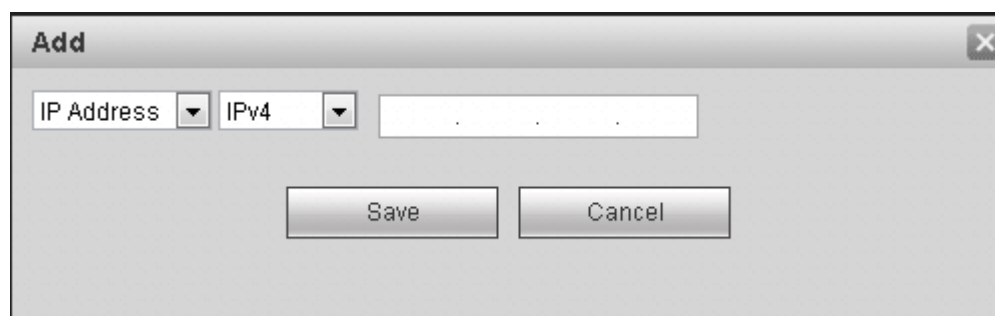

Figure 5-93

5.10.5.5.1 Reset password



Note

- The reset password function is enabled by default. If you forgot admin password, click **Forgot password** on the login interface to reset password. Refer to chapter 5.4 Reset password for detailed information.
- If you disabled reset password function, you cannot use the email to reset password. You need to answer the security question to reset. If you have not set security question, system prompts “Reset password is disabled!”

Follow the steps listed below to disable reset password.

Step 1 From Setting->System->Security->Reset password.

Enter reset password interface. The reset password is enabled by default. See Figure 5-94.



Figure 5-94

- Step 2 Check the box to disable reset function.
- Step 3 Click OK button.
- Step 4 System pops up a dialogue box to remind you to answer security question to to reset password. Click OK to complete settings.

5.10.5.6 Auto maintain

The auto maintain interface is shown as in Figure 5-95.

Here you can select auto reboot and auto delete old files interval from the dropdown list.

If you want to use the auto delete old files function, you need to set the file period.

Click Manual reboot button, you can restart device manually.

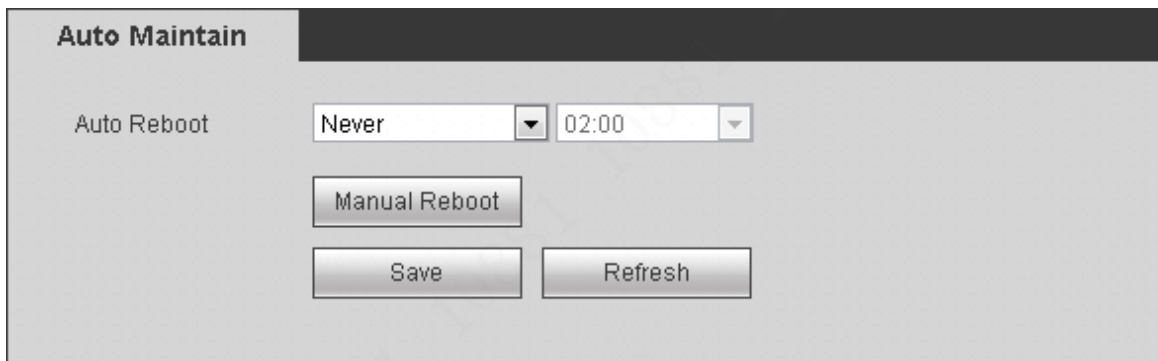

Figure 5-95

5.10.5.7 Import/Export

The interface is shown as in Figure 5-96. This interface is for you to export or import the configuration files.



Figure 5-96

Please refer to the following sheet for detailed information.

Parameter	Function
Browse	Click to select import file.

Parameter	Function
Import	It is to import the local setup files to the system.
Export	It is to export the corresponding WEB setup to your local PC.

5.10.5.8 Default

The default setup interface is shown as in Figure 5-97.

Here you can select Network/Event/Storage/Setting/Camera. Or you can check the All box to select all items.

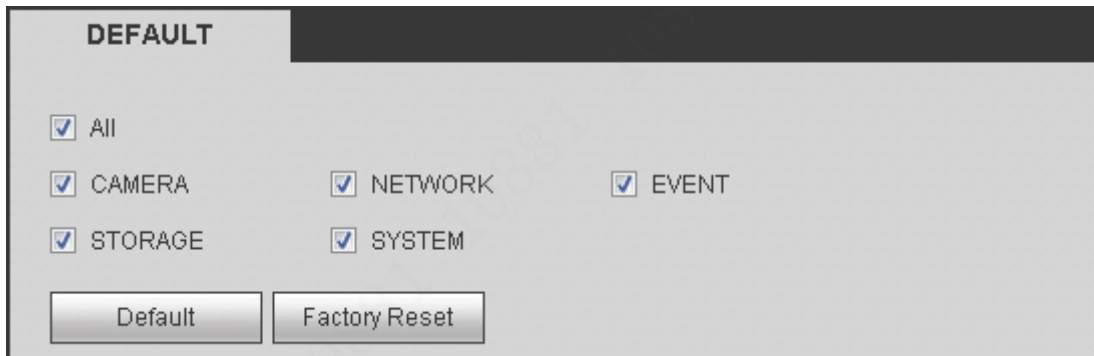

Figure 5-97

5.10.5.9 Upgrade



CAUTION

- During the upgrade process, do not unplug the power cable, network cable, or shutdown the device.
- Improper upgrade program may result in device malfunction!

There are two upgrade modes: file upgrade and online upgrade.

5.10.5.9.1.1 File Upgrade

The upgrade interface is shown as in Figure 5-98.

Please select the upgrade file and then click the update button to begin update. Please note the file name shall be as *.bin.

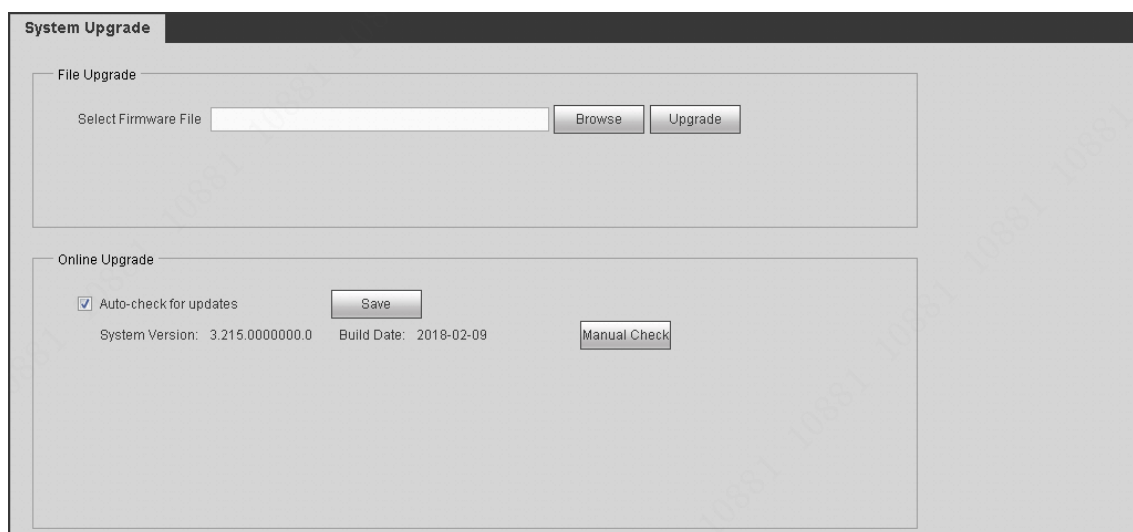

Figure 5-98

5.10.5.9.1.2 Online Upgrade

When the NVR is online, you can use the online upgrade to update the firmware.

Note

Make sure the NVR has properly connected to the network.

Version Detection

The version detection includes auto detection and manual detection. It displays current system version and application released date.

- Enable auto detection, NVR interacts with the cloud every day to detect if there is a new version available. When there is a new version, system marks a red point on the Upgrade tab.

Note

To inform you upgrading firmware timely, we will collect your device information such as IP address, device name, firmware version and serial number. The collected information is used for verifying device legality and pushing upgrade notice.

- Click manual detection to view the latest new version on the cloud.
 - If current version is the latest one, system prompts that “It is the latest version”.
 - If there is new version available, system displays new version information such as release date and corresponding release note.

Upgrade System

Click Start to upgrade the system.

5.11 Information

5.11.1 Version

The version interface is shown as in Figure 5-99. Please note the following information for reference only. Here you can view record channel, alarm input/output information, software version, release date and etc. When there is any new version, it prompts found new version. Click it, NVR goes to upgrade interface.

Version	
Type	NVR
Record Channel:	4
SN:	QHH12345QWERTQWER
Web Version:	3.1.0.66469
System Version:	3.205.0000001.0
Build Date:	2017-11-11
Onvif Client Version	2.4.1

Figure 5-99

5.11.2 Log

Here you can view system log. See Figure 5-100.

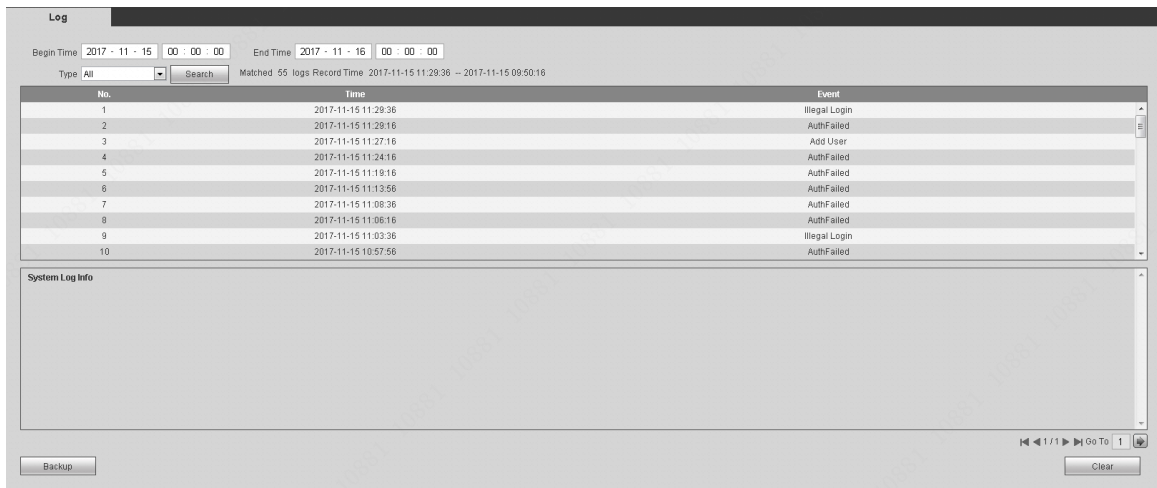

Figure 5-100

Please refer to the following sheet for log parameter information.

Parameter	Function
Type	Log types include: system operation, configuration operation, data operation, event operation, record operation, user management, log clear.
Start time	Set the start time of the requested log.
End time	Set the end time of the requested log.
Search	You can select log type from the drop down list and then click search button to view the list. You can click the stop button to terminate current search operation.
Detailed information	You can select one item to view the detailed information.
Clear	You can click this button to delete all displayed log files. Please note system does not support clear by type.
Backup	You can click this button to backup log files to current PC.

5.11.3 Online User

The online user interface is shown as in Figure 5-101.



Figure 5-101

5.11.4 HDD

From main menu->Info->HDD, the HDD interface is shown as in Figure 5-102. Here you can view HDD information.

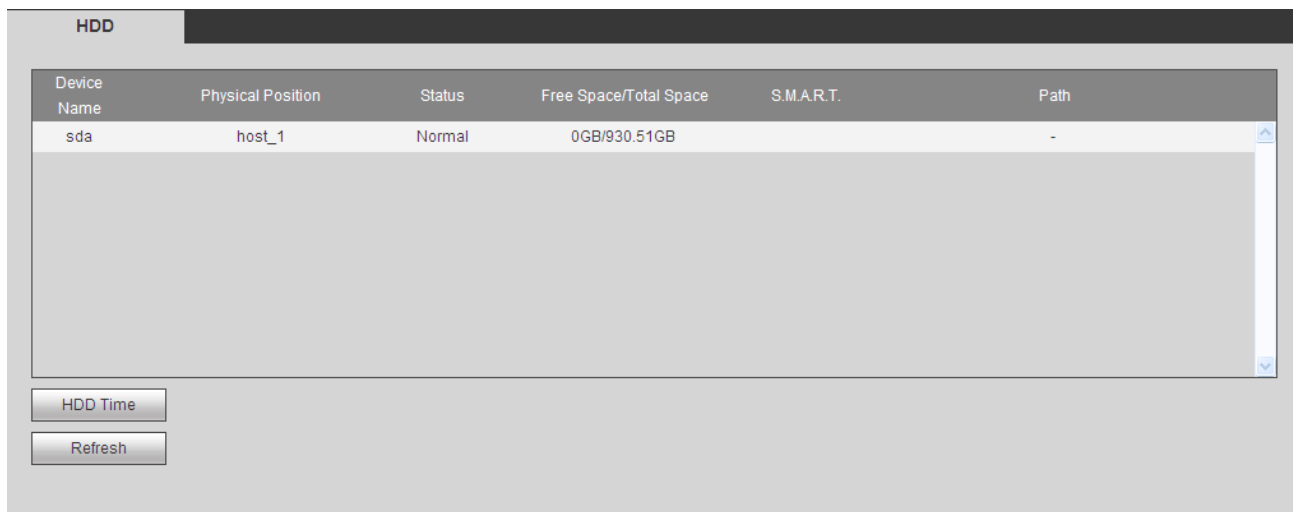

Figure 5-102

5.12 Playback

Click Playback button, you can see an interface is shown as in Figure 5-103.

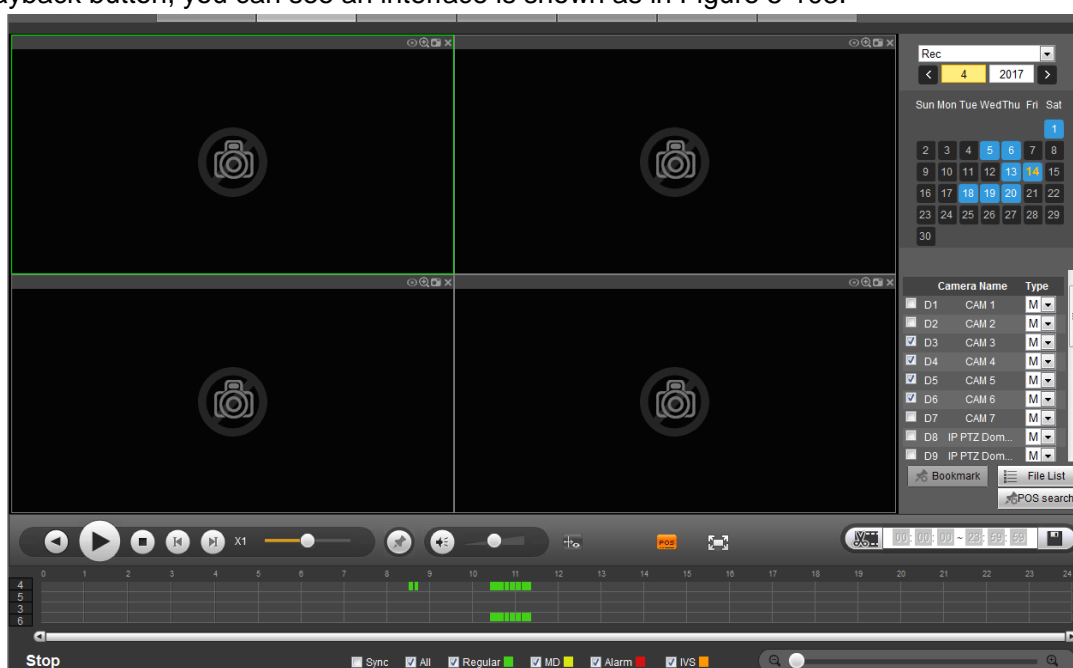

Figure 5-103

5.12.1 Search Record

Please set record type, record date, window display mode and channel name.

- Select Date

You can click the date on the right pane to select the date. The green highlighted date is system current date and the blue highlighted date means it has record files.

- Window Split

Select window split mode. Click  to display in full screen. Click ESC button to exit. See Figure 5-104.



Figure 5-104

- Select Channel
1~4 means main stream and A1~A4 means sub stream.
- Select Record Type
Check the corresponding box to select record type. See Figure 5-105.

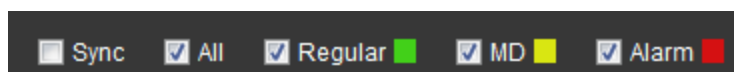

Figure 5-105

5.12.2 File List

Click File list button, you can see the corresponding files in the list. See Figure 5-106.



Figure 5-106

5.12.3 Playback

Select a file you want to play and then click Play button, system can begin playback. You can select to playback in full-screen. Please note for one channel, system cannot playback and download at the same time. You can use the playback control bar to implement various operations such as play, pause, stop, slow play, fast play and etc. See Figure 5-107.

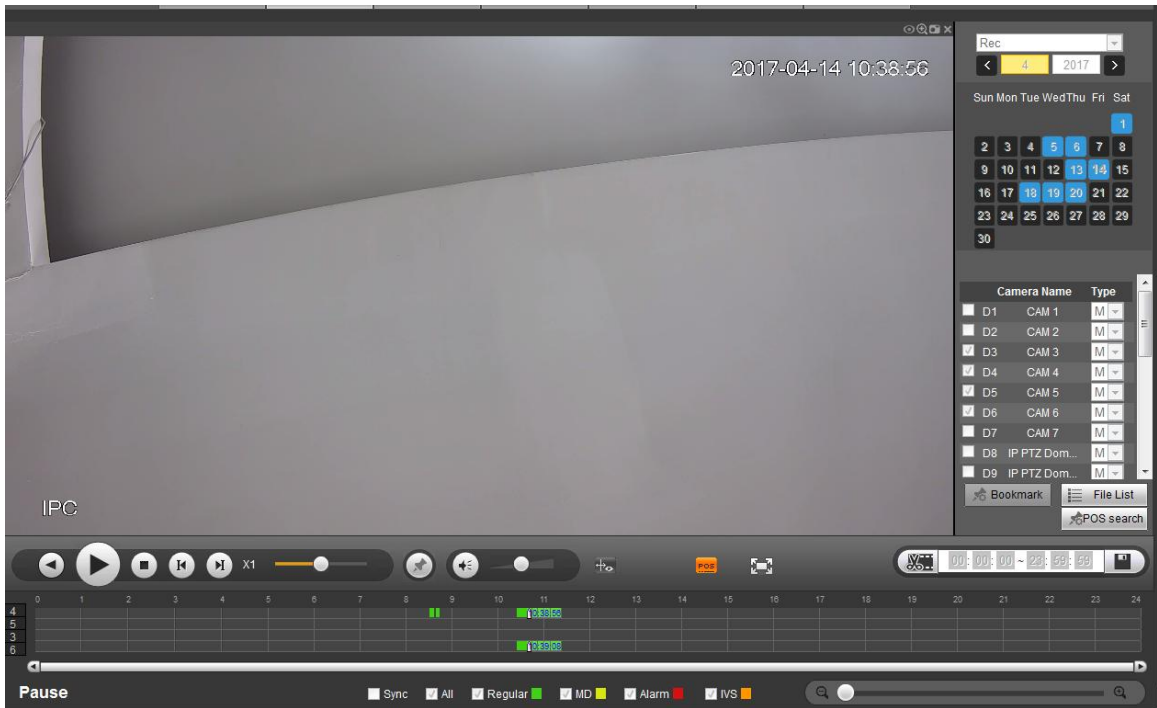

Figure 5-107

5.12.4 Download

Select the file(s) you want to download and then click download button, you can see an interface shown as in Figure 5-108. The Download button becomes Stop button and there is a process bar for your reference. Please go to you default file saved path to view the files.



Figure 5-108

5.12.5 Load more

It is for you to search record or picture. You can select record channel, record type and record time to download. Or you can use watermark function to verify file.

5.12.5.1 Download By File

Select channel, record type, bit stream type and then input start time and end time. Click Search button, the download by file interface is shown as in Figure 5-109.

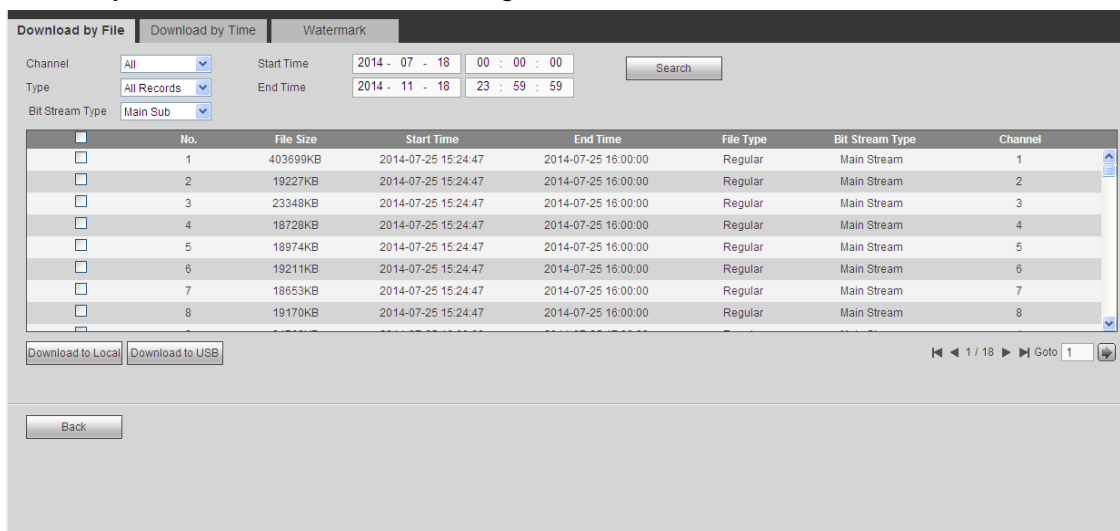

Figure 5-109

Check the file(s) you want to download and there are two options for you to save the file(s).

- Download to local

Click Download to local, system pops up the following interface for you to set record format and saved path. See Figure 5-110.

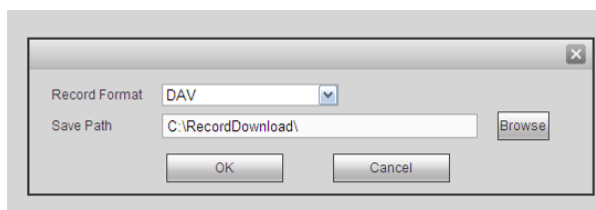

Figure 5-110

You can click OK to download and view the download process. After the download operation, you can see corresponding dialog box.

- Download to USB

Connect the corresponding peripheral device, and then click Download to USB button, you can see the following interface. See Figure 5-111.

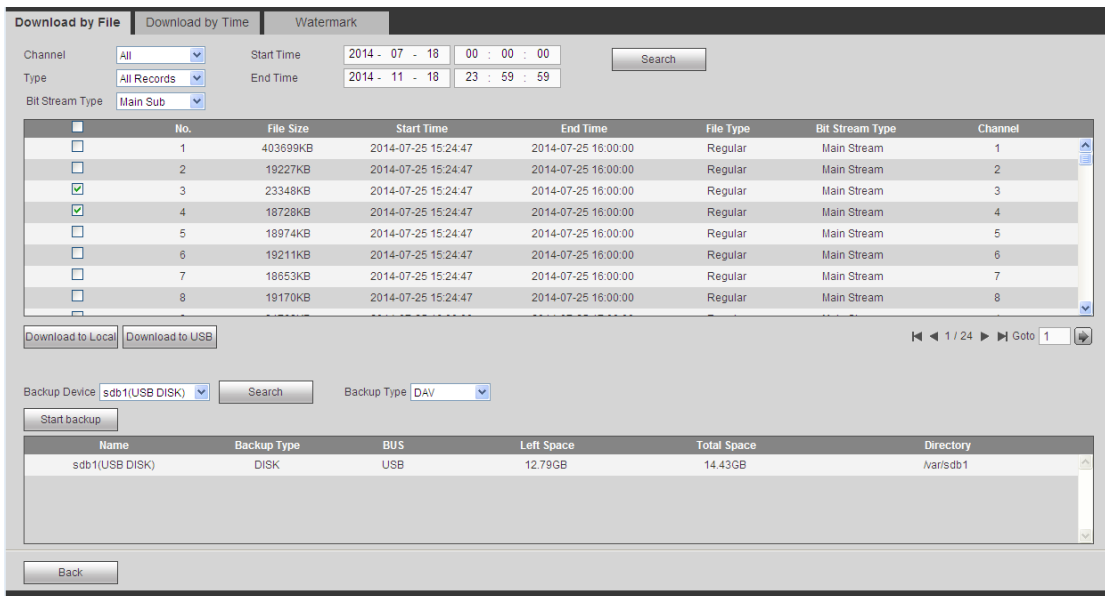

Figure 5-111

Select Backup device and backup type first and then click Start backup button. After the download operation, you can see corresponding dialog box.

5.12.5.2 Download by Time

Select channel, bit stream type, start time and end time.

Click Download to Local button, you can see download by time interface is shown as in Figure 5-112.

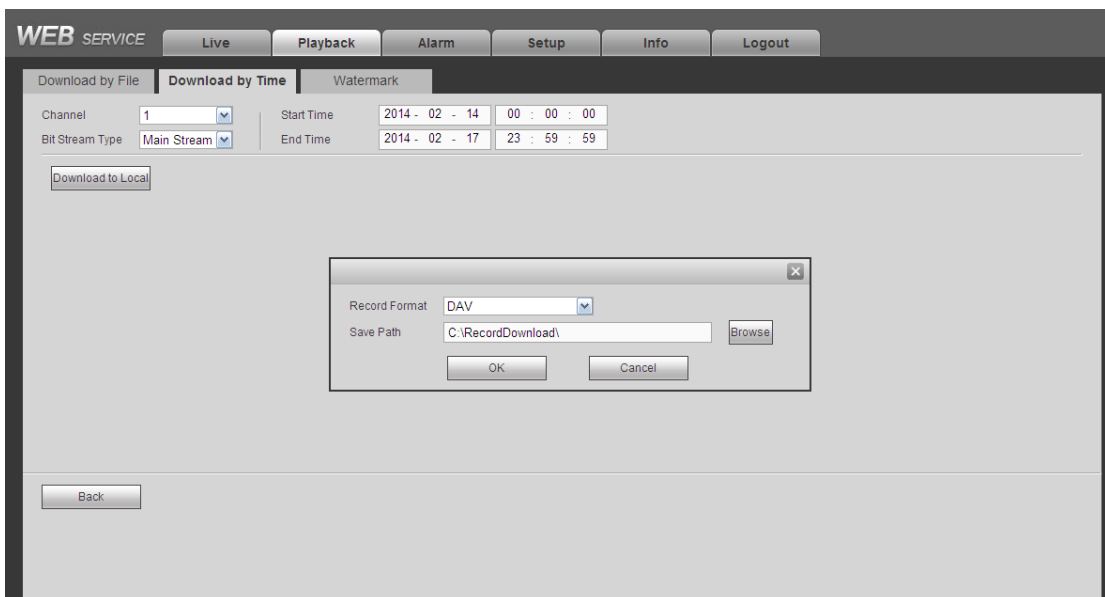

Figure 5-112

Set record format and saved path, you can click OK to download and view the download process. After the download operation, you can see corresponding dialog box.

5.12.5.3 Watermark

Watermark interface is shown as In Figure 5-113. Please select a file and then click Verify button to see the file has been tampered with or not

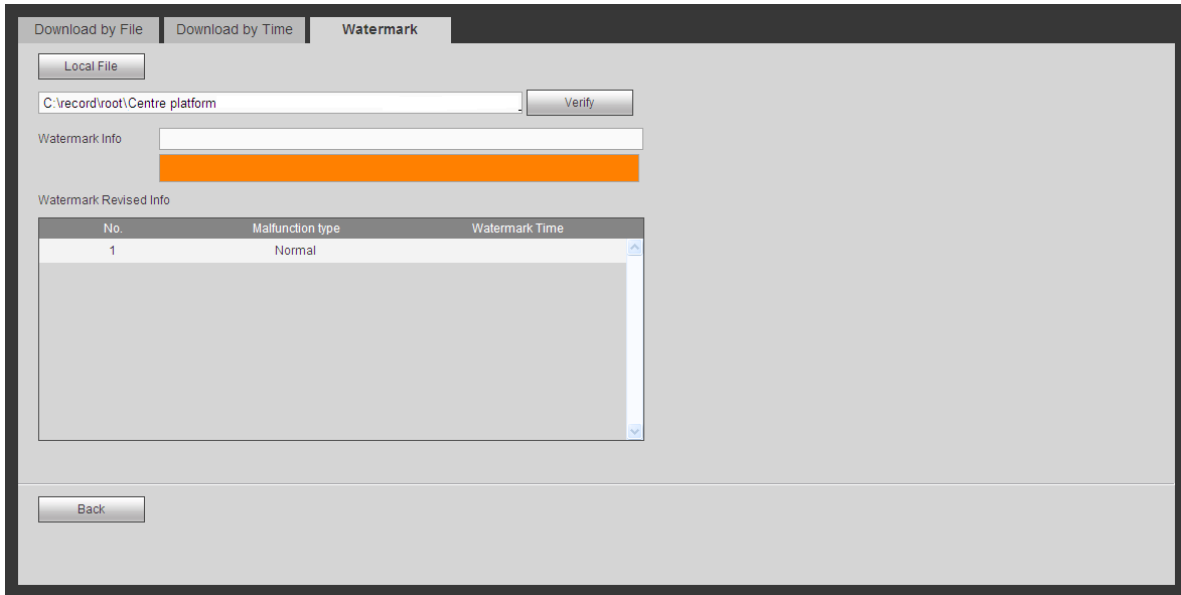

Figure 5-113

5.13 Alarm

Click alarm function, you can see an interface is shown as Figure 5-114.

Here you can set device alarm type and alarm sound setup (Please make sure you have enabled audio function of corresponding alarm events.).



Figure 5-114

Please refer to the following sheet for detailed information.

Type	Parameter	Function
	Motion detection	System alarms when motion detection alarm occurs.
	Tampering	System alarms when camera is viciously masking.
	Disk full	System alarms when disk is full.
	Disk error	System alarms when disk error occurs.
	IPC external alarm	It refers to the on-off signal from the network camera. It can activate the NVR local activation operation.
	IPC offline alarm	System can generate an alarm when the network camera and the NVR are disconnected.

Type	Parameter	Function
Operation	Prompt	Check the box here, system can automatically pops up an alarm icon on the Alarm button in the main interface when there is an alarm.
Alarm Sound	Play alarm sound	System sends out alarm sound when an alarm occurs. You can specify as you wish.
	Sound path	Here you can specify alarm sound file.

5.14 Log out

Click log out button, system goes back to log in interface. See Figure 5-115.

You need to input user name and password to login again.



The image shows a login interface for EZ-IP. At the top left is the 'EZ-IP' logo, and at the top right is a camera lens icon. The interface contains the following fields and controls:

- User Name:
- Password: Plain Text
- Type: [Forgot password?](#)
- Connection type: LAN WAN
- Buttons:

Figure 5-115

5.15 Un-install Web Control

You can use web un-install tool “uninstall web.bat” to un-install web control.

Please note, before you un-installation, please close all web pages, otherwise the un-installation might result in error

6 Glossary

- **DHCP:** DHCP (Dynamic Host Configuration Protocol) is a network protocol. It is one of the TCP/IP protocol cluster. It is principally used to assign temporary IP addresses to computers on a network.
- **DDNS:** DDNS (Dynamic Domain Name Server) is a service that maps Internet domain names to IP addresses. This service is useful to anyone who wants to operate a server (web server, mail server, ftp server and etc) connected to the internet with a dynamic IP or to someone who wants to connect to an office computer or server from a remote location with software.
- **eSATA:** eSATA(External Serial AT) is an interface that provides fast data transfer for external storage devices. It is the extension specifications of a SATA interface.
- **GPS:** GPS (Global Positioning System) is a satellite system, protected by the US military, safely orbiting thousands of kilometers above the earth.
- **PPPoE: PPPoE** (Point to Point Protocol over Ethernet) is a specification for connecting multiple computer users on an Ethernet local area network to a remote site. Now the popular mode is ADSL and it adopts PPPoE protocol.
- **WIFI:** Wi-Fi is the name of a popular wireless networking technology that uses radio waves to provide wireless high-speed Internet and network connections. The standard is for wireless local area networks (WLANs). It is like a common language that all the devices use to communicate to each other. It is actually IEEE802.11, a family of standard The IEEE (Institute of Electrical and Electronics Engineers Inc.)
- **3G:** 3G is the wireless network standard. It is called 3G because it is the third generation of cellular telecom standards. 3G is a faster network for phone and data transmission and speed is over several hundred kbps. Now there are four standards: CDMA2000, WCDMA, TD-SCDMA and WiMAX.
- **Dual-stream:** The dual-stream technology adopts high-rate bit stream for local HD storage such as QCIF/CIF/2CIF/DCIF/4CIF encode and one low-rate bit stream for network transmission such as QCIF/CIF encode. It can balance the local storage and remote network transmission. The dual-stream can meet the difference band width requirements of the local transmission and the remote transmission. In this way, the local transmission using high-bit stream can achieve HD storage and the network transmission adopting low bit stream suitable for the fluency requirements of the 3G network such as WCDMA, EVDO, TD-SCDMA..
- **On-off value:** It is the non-consecutive signal sampling and output. It includes remote sampling and remote output. It has two statuses: 1/0.

7 FAQ

Questions	Solutions
<p>NVR cannot boot up properly.</p>	<ul style="list-style-type: none"> ● Input power is not correct. ● Power connection is not correct. ● Power switch button is damaged. ● Program upgrade is wrong. ● HDD malfunction or something wrong with HDD ribbon. ● Seagate DB35.1, DB35.2, SV35 or Maxtor 17-g has compatibility problem. Please upgrade to the latest version to solve this problem. ● Front panel error. ● Main board is damaged.
<p>NVR often automatically shuts down or stops running.</p>	<ul style="list-style-type: none"> ● Input voltage is not stable or it is too low. ● HDD malfunction or something wrong with the ribbon. ● Button power is not enough. ● Front video signal is not stable. ● Working environment is too harsh, too much dust. ● Hardware malfunction.
<p>System cannot detect hard disk.</p>	<ul style="list-style-type: none"> ● HDD is broken. ● HDD ribbon is damaged. ● HDD cable connection is loose. ● Main board SATA port is broken.
<p>There is no video output whether it is one-channel, multiple-channel or all-channel output.</p>	<ul style="list-style-type: none"> ● Program is not compatible. Please upgrade to the latest version. ● Brightness is 0. Please restore factory default setup. ● Check your screen saver. ● NVR hardware malfunctions.
<p>I cannot search local records.</p>	<ul style="list-style-type: none"> ● HDD ribbon is damaged. ● HDD is broken. ● Upgraded program is not compatible. ● The recorded file has been overwritten. ● Record function has been disabled.
<p>Video is distorted when searching local records.</p>	<ul style="list-style-type: none"> ● Video quality setup is too low. ● Program read error, bit data is too small. There is mosaic in the full screen. Please restart the NVR to solve this problem. ● HDD data ribbon error. ● HDD malfunction. ● NVR hardware malfunctions.
<p>Time display is not correct.</p>	<ul style="list-style-type: none"> ● Setup is not correct ● Battery contact is not correct or voltage is too low. ● Crystal is broken.

Questions	Solutions
NVR cannot control PTZ.	<ul style="list-style-type: none"> ● Front panel PTZ error ● PTZ decoder setup, connection or installation is not correct. ● Cable connection is not correct. ● PTZ setup is not correct. ● PTZ decoder and NVR protocol is not compatible. ● PTZ decoder and NVR address is not compatible. ● When there are several decoders, please add 120 Ohm between the PTZ decoder A/B cables furthest end to delete the reverberation or impedance matching. Otherwise the PTZ control is not stable. ● The distance is too far.
I cannot log in client-end or web.	<ul style="list-style-type: none"> ● For Windows 98 or Windows ME user, please update your system to Windows 2000 sp4. Or you can install client-end software of lower version. Please note right now, our NVR is not compatible with Windows VISTA control. ● ActiveX control has been disabled. ● No dx8.1 or higher. Please upgrade display card driver. ● Network connection error. ● Network setup error. ● Password or user name is invalid. ● Client-end is not compatible with NVR program.
There is only mosaic no video when preview or playback video file remotely.	<ul style="list-style-type: none"> ● Network fluency is not good. ● Client-end resources are limit. ● Current user has no right to monitor.
Network connection is not stable.	<ul style="list-style-type: none"> ● Network is not stable. ● IP address conflict. ● MAC address conflict. ● PC or device network card is not good.
Burn error /USB back error.	<ul style="list-style-type: none"> ● Burner and NVR are in the same data cable. ● System uses too much CPU resources. Please stop record first and then begin backup. ● Data amount exceeds backup device capacity. It may result in burner error. ● Backup device is not compatible. ● Backup device is damaged.
Keyboard cannot control NVR.	<ul style="list-style-type: none"> ● NVR serial port setup is not correct ● Address is not correct ● When there are several switchers, power supply is not enough. ● Transmission distance is too far.

Questions	Solutions
Alarm signal cannot be disarmed.	<ul style="list-style-type: none"> ● Alarm setup is not correct. ● Alarm output has been open manually. ● Input device error or connection is not correct. ● Some program versions may have this problem. Please upgrade your system.
Alarm function is null.	<ul style="list-style-type: none"> ● Alarm setup is not correct. ● Alarm cable connection is not correct. ● Alarm input signal is not correct. ● There are two loops connect to one alarm device.
Record storage period is not enough.	<ul style="list-style-type: none"> ● Camera quality is too low. Lens is dirty. Camera is installed against the light. Camera aperture setup is not correct. ● HDD capacity is not enough. ● HDD is damaged.
Cannot playback the downloaded file.	<ul style="list-style-type: none"> ● There is no media player. ● No DXB8.1 or higher graphic acceleration software. ● There is no DivX503Bundle.exe control when you play the file transformed to AVI via media player. ● No DivX503Bundle.exe or ffdshow-2004 1012 .exe in Windows XP OS.
Forgot local menu operation password or network password	<ul style="list-style-type: none"> ● Please contact your local service engineer or our sales person for help. We can guide you to solve this problem.
There is no video. The screen is in black.	<ul style="list-style-type: none"> ● IPC IP address is not right. ● IPC port number is not right. ● IPC account (user name/password) is not right. ● IPC is offline.
The displayed video is not full in the monitor.	Please check current resolution setup. If the current setup is 1920*1080, then you need to set the monitor resolution as 1920*1080.
There is no HDMI output.	<ul style="list-style-type: none"> ● Displayer is not in HDMI mode. ● HDMI cable connection is not right.
The video is not fluent when I view in multiple-channel mode from the client-end.	<ul style="list-style-type: none"> ● The network bandwidth is not sufficient. The multiple-channel monitor operation needs at least 100M or higher. ● Your PC resources are not sufficient. For 16-ch remote monitor operation, the PC shall have the following environment: Quad Core, 2G or higher memory, independent displayer, display card memory 256M or higher.

Questions	Solutions
I can not connect to the IPC	<ul style="list-style-type: none"> ● Please make sure the IPC has booted up. ● IPC network connection is right and it is online ● IPC IP is in the blacklist. ● The device has connected to the too many IPC. It cannot transmit the video. ● Check the IPC port value and the time zone is the same as the NVR. ● Make sure current network environment is stable.
After I set the NVR resolution as 1080P, my monitor can not display.	Shut down the device and then reboot. When you reboot, please press the Fn button at the same time and then release after 5 seconds. You can restore NVR resolution to the default setup.
My admin account has been changed and I can not log in.	Use telnet and then input the following command: <pre>cd /mnt/mtd/Config/ rm -rf group rm -rf password</pre> Reboot the device to restore the default password.
After I login the Web , I can not find the remote interface to add the IPC.	Please clear the Web controls and load again.
There is IP and gateway, I can access the internet via the router. But I can not access the internet after I reboot the NVR.	Please use command PING to check you can connect to the gateway or not. Use telnet to access and then use command "ifconfig -a" to check device IP address. If you see the subnet mask and the gateway has changed after the reboot. Please upgrade the applications and set again.
I use the VGA montior.I want to know if I use the multiple-window mode, I see the video from the main stream or the sub stream?	<ul style="list-style-type: none"> ● For 32-channel series product, the 9/16-window is using the sub stream. ● For 4/8/16 series product, system is using the main stream no matter you are in what display mode.

Daily Maintenance

- Please use the brush to clean the board, socket connector and the chassis regularly.
- The device shall be soundly earthed in case there is audio/video disturbance. Keep the device away from the static voltage or induced voltage.
- Please unplug the power cable before you remove the audio/video signal cable, RS232 or RS485 cable.
- Do not connect the TV to the local video output port (VOUT).It may result in video output circuit.
- Always shut down the device properly. Please use the shutdown function in the menu, or you can press the power button in the rear pane for at least three seconds to shut down the device.

Otherwise it may result in HDD malfunction.

- Please make sure the device is away from the direct sunlight or other heating sources. Please keep the sound ventilation.
- Please check and maintain the device regularly.

8 Appendix A HDD Capacity Calculation

Calculate total capacity needed by each device according to video recording (video recording type and video file storage time).

Step 1: According to Formula (1) to calculate storage capacity q_i that is the capacity of each channel needed for each hour, unit Mbyte.

$$q_i = d_i \div 8 \times 3600 \div 1024 \quad (1)$$

In the formula: d_i means the bit rate, unit Kbit/s

Step 2: After video time requirement is confirmed, according to Formula (2) to calculate the storage capacity m_i , which is storage of each channel needed unit Mbyte.

$$m_i = q_i \times h_i \times D_i \quad (2)$$

In the formula:

h_i means the recording time for each day (hour)

D_i means number of days for which the video shall be kept

Step 3: According to Formula (3) to calculate total capacity (accumulation) q_T that is needed for all channels in the device during **scheduled video recording**.

$$q_T = \sum_{i=1}^c m_i \quad (3)$$

In the formula: c means total number of channels in one device

Step 4: According to Formula (4) to calculate total capacity (accumulation) q_T that is needed for all channels in device during **alarm video recording (including motion detection)**.

$$q_T = \sum_{i=1}^c m_i \times a\% \quad (4)$$

In the formula: $a\%$ means alarm occurrence rate

9 Appendix B Compatible Network Camera List

Please note all the models in the following list for reference only. For those products not included in the list, please contact your local retailer or technical supporting engineer for detailed information.

Manufacture	Model	Version	Video Encode	Audio/Video	Protocol
AXIS	P1346	5.40.9.2	H264	√	ONVIF/Private
	P3344/P3344-E	5.40.9.2	H264	√	ONVIF/Private
	P5512	—	H264	√	ONVIF/Private
	Q1604	5.40.3.2	H264	√	ONVIF/Private
	Q1604-E	5.40.9	H264	√	ONVIF/Private
	Q6034E	—	H264	√	ONVIF/Private
	Q6035	5.40.9	H264	√	ONVIF/Private
	Q1755	—	H264	√	ONVIF/Private
	M7001	—	H264	√	Private
	M3204	5.40.9.2	H264	√	Private
	P3367	HEAD LFP4_0 130220	H264	√	ONVIF
	P5532-P	HEAD LFP4_0 130220	H264	√	ONVIF
ACTi	ACM-3511	A1D-220-V3.12 .15-AC	MPEG4	√	Private
	ACM-8221	A1D-220-V3.13 .16-AC	MPEG4	√	Private
Arecont	AV1115	65246	H264	√	Private
	AV10005DN	65197	H264	√	Private
	AV2115DN	65246	H264	√	Private
	AV2515DN	65199	H264	√	Private
	AV2815	65197	H264	√	Private
	AV5115DN	65246	H264	√	Private
	AV8185DN	65197	H264	√	Private
Bosch	NBN-921-P	—	H264	√	ONVIF
	NBC-455-12P	—	H264	√	ONVIF
	VG5-825	9500453	H264	√	ONVIF
	NBN-832	66500500	H264	√	ONVIF
	VEZ-211-IWT EIVA	—	H264	√	ONVIF
	NBC-255-P	15500152	H264	√	ONVIF
	VIP-X1XF	—	H264	√	ONVIF
Brikcom	B0100	—	H264	√	ONVIF
	D100	—	H264	√	ONVIF
	GE-100-CB	—	H264	√	ONVIF
	FB-100A	v1.0.3.9	H264	√	ONVIF
	FD-100A	v1.0.3.3	H264	√	ONVIF

Manufacture	Model	Version	Video Encode	Audio/Video	Protocol
Cannon	VB-M400	—	H264	√	Private
CNB	MPIx2.0DIR	XNETM112011 1229	H264	√	ONVIF
	VIPBL1.3MIR VF	XNETM210011 1229	H264	√	ONVIF
	IGC-2050F	XNETM210011 1229	H264	√	ONVIF
CP PLUS	CP-NC9-K	6.E.2.7776	H264	√	ONVIF/Private
	CP-NC9W-K	6.E.2.7776	H264	√	Private
	CP-ND10-R	cp20111129AN S	H264	√	ONVIF
	CP-ND20-R	cp20111129AN S	H264	√	ONVIF
	CP-NS12W-C R	cp20110808NS	H264	√	ONVIF
	VS201	cp20111129NS	H264	√	ONVIF
	CP-NB20-R	cp20110808BN S	H264	√	ONVIF
	CP-NT20VL3- R	cp20110808BN S	H264	√	ONVIF
	CP-NS36W-A R	cp20110808NS	H264	√	ONVIF
	CP-ND20VL2- R	cp20110808BN S	H264	√	ONVIF
	CP-RNP-1820	cp20120821NS A	H264	√	Private
	CP-RNC-TP2 0FL3C	cp20120821NS A	H264	√	Private
	CP-RNP-12D	cp20120828AN S	H264	√	Private
	CP-RNC-DV1 0	cp20120821NS A	H264	√	Private
	CP-RNC-DP2 0FL2C	cp20120821NS A	H264	√	Private
Dynacolor	ICS-13	d20120214NS	H264	√	ONVIF/Private
	ICS-20W	vt20111123NSA	H264	√	ONVIF/Private
	NA222	—	H264	√	ONVIF
	MPC-IPVD-03 13	k20111208ANS	H264	√	ONVIF/Private
	MPC-IPVD-03 13AF	k20111208BNS	H264	√	ONVIF/Private
Honeywell	HIDC-1100PT	h.2.2.1824	H264	√	ONVIF
	HIDC-1100P	h.2.2.1824	H264	√	ONVIF

Manufacture	Model	Version	Video Encode	Audio/Video	Protocol
	HIDC-0100P	h.2.2.1824	H264	√	ONVIF
	HIDC-1300V	2.0.0.21	H264	√	ONVIF
	HICC-1300W	2.0.1.7	H264	√	ONVIF
	HICC-2300	2.0.0.21	H264	√	ONVIF
	HDZ20HDX	H20130114NS A	H264	√	ONVIF
LG	LW342-FP	—	H264	√	Private
	LNB5100	—	H264	√	ONVIF
Imatek	KNC-B5000	—	H264	√	Private
	KNC-B5162	—	H264	√	Private
	KNC-B2161	—	H264	√	Private
Panasonic	NP240/CH	—	MPEG4	√	Private
	WV-NP502	—	MPEG4	√	Private
	WV-SP102H	1.41	H264	√	ONVIF/Private
	WV-SP105H	—	H264	√	ONVIF/Private
	WV-SP302H	1.41	H264、MPEG4	√	ONVIF/Private
	WV-SP306H	1.4	H264、MPEG4	√	ONVIF/Private
	WV-SP508H	—	H264、MPEG4	√	ONVIF/Private
	WV-SP509H	—	H264、MPEG4	√	ONVIF/Private
	WV-SF332H	1.41	H264、MPEG4	√	ONVIF/Private
	WV-SW316H	1.41	H264、MPEG4	√	ONVIF/Private
	WV-SW355H	1.41	H264、MPEG4	√	ONVIF/Private
	WV-SW352H	—	H264、MPEG4	√	ONVIF/Private
	WV-SW152E	1.03	H264、MPEG4	√	ONVIF/Private
	WV-SW558H	—	H264、MPEG4	√	ONVIF/Private
	WV-SW559H	—	H264、MPEG4	√	ONVIF/Private
	WV-SP105H	1.03	H264、MPEG4	√	ONVIF/Private
	WV-SW155E	1.03	H264、MPEG4	√	ONVIF/Private
	WV-SF336H	1.44	H264、MPEG4	√	ONVIF/Private
	WV-SF332H	1.41	H264、MPEG4	√	ONVIF/Private
	WV-SF132E	1.03	H264、MPEG4	√	ONVIF/Private
	WV-SF135E	1.03	H264、MPEG4	√	ONVIF/Private
	WV-SF346H	1.41	H264、MPEG4	√	ONVIF/Private
	WV-SF342H	1.41	H264、MPEG4	√	ONVIF/Private
	WV-SC385H	1.08	H264、MPEG4	√	ONVIF/Private
	WV-SC386H	1.08	H264、MPEG4	√	ONVIF/Private
	WV-SP539	1.66	H264、MPEG4	√	ONVIF
	DG-SC385	1.66	H264、MPEG4	√	ONVIF
PELCO	IXSOLW	1.8.1-20110912 -1.9082-A1.661 7	H264	√	Private
	IDE20DN	1.7.41.9111-O3 .6725	H264	√	Private

Manufacture	Model	Version	Video Encode	Audio/Video	Protocol
	D5118	1.7.8.9310-A1.5288	H264	√	Private
	IM10C10	1.6.13.9261-O2.4657	H264	√	Private
	DD4N-X	01.02.0015	MPEG4	√	Private
	DD423-X	01.02.0006	MPEG4	√	Private
	D5220	1.8.3-FC2-20120614-1.9320-A1.8035	H264	√	Private
Samsung	SNB-3000P	2.41	H264、MPEG4	√	ONVIF/Private
	SNP-3120	1.22_110120_1	H264、MPEG4	√	ONVIF/Private
	SNP-3370	1.21_110318	MPEG4	√	Private
	SNB-5000	2.10_111227	H264、MPEG4	√	ONVIF/Private
	SND-5080	—	H264、MPEG4	√	Private
	SNZ-5200	1.02_110512	H264、MPEG4	√	ONVIF/Private
	SNP-5200	1.04_110825	H264、MPEG4	√	ONVIF/Private
	SNB-7000	1.10_110819	H264	√	ONVIF/Private
	SNB-6004	V1.0.0	H264	√	ONVIF
Sony	SNC-DH110	1.50.00	H264	√	ONVIF/Private
	SNC-CH120	1.50.00	H264	√	ONVIF/Private
	SNC-CH135	1.73.01	H264	√	ONVIF/Private
	SNC-CH140	1.50.00	H264	√	ONVIF/Private
	SNC-CH210	1.73.00	H264	√	ONVIF/Private
	SNC-DH210	1.73.00	H264	√	ONVIF/Private
	SNC-DH240	1.50.00	H264	√	ONVIF/Private
	SNC-DH240-T	1.73.01	H264	√	ONVIF/Private
	SNC-CH260	1.74.01	H264	√	ONVIF/Private
	SNC-CH280	1.73.01	H264	√	ONVIF/Private
	SNC-RH-124	1.73.00	H264	√	ONVIF/Private
	SNC-RS46P	1.73.00	H264	√	ONVIF/Private
	SNC-ER550	1.74.01	H264	√	ONVIF/Private
	SNC-ER580	1.74.01	H264	√	ONVIF/Private
	SNC-ER580	1.78.00	H264	√	ONVIF
	SNC-VM631	1.4.0	H264	√	ONVIF
	WV-SP306	1.61.00	H264、MPEG4	√	SDK
	WV-SP306	1.61.00	H264	√	ONVIF
	SNC-VB600	1.5.0	H264	√	Private
	SNC-VM600	1.5.0	H264	√	Private
SNC-VB630	1.5.0	H264	√	Private	
SNC-VM630	1.5.0	H264	√	Private	
SANYO	VCC-HDN4000PC	—	H264	√	ONVIF