

STACK100

USER MANUAL

Battery Module
51.2V/100Ah

Contents

Statement of Law	1
Revision History	1
Safe handling of lithium batteries guide	2
1 Introduction	4
Brief Introduction	4
Product Properties	4
Product identity definition	5
2 Product specifications	7
System Performance Parameter	7
Battery Module	10
Battery controller	13
3 Installation and Configuration	18
Environmental Requirements	18
Installation location precautions	19
Equipment installation	27
Battery Capacity Description	39
Electrical installation	40
App Operation Instruction	45
4 Maintenance	51
Troubleshooting	51
Replacement of Main Components	53
Battery Maintenance	54
5 Storage	55
6 Shipment	55
Annex 1 Stack100 Expansion Pack Usage Guide	56
EU Declaration of Conformity	63

Statement of Law

Copyright of this document belongs to Dyness Digital Energy Technology Co., LTD..

No part of this documentation may be excerpted, reproduced, translated, annotated or duplicated in any form or by any means without the prior written authorization of Dyness Digital Energy Technology Co., LTD. All Rights Reserved.

This product complies with the design requirements of environmental protection and personal safety. The storage, use and disposal of the products shall be carried out in accordance with the product manual, relevant contract or relevant laws and regulations.

You can check the related information on the website of Dyness Digital Energy Technology Co., LTD. when the product or technology is updated.

Web URL: <http://www.dyness.com/>

Please note that the product can be modified without prior notification.

Revision History

Revision No.	Revision Date	Revision Reason
V0	2024.07.31	First Published
V1	2024.12.16	Parameters changed
V2	2025.03.07	Add Installation precautions
V3	2025.11.13	Increase safety distance, add noise reduction signs, and add TCP/IP interfaces
V4	2026.5.6	Add noise level

Safe handling of lithium batteries guide



DANGER

Before installation or operation you must read the “STACK100 User Manual” carefully.

The batteries will produce high-voltage DC power and might cause lethal voltage and electric shock.

Only qualified persons are allowed to wire the batteries.



WARNING

This product is a high-voltage DC system, and should be operated by authorized persons only.

Risk of battery system damage or personal injury.

DO NOT disconnect while the system is running!

Keep all power sources off and verify that they are de-energized.

Battery damage may result in electrolyte leakage. If the electrolyte is leaked, do not touch the leaked electrolyte or volatile gas, and contact the after-sales service team for help immediately. If leaked material was touched accidentally, please follow the steps below:

- Inhalation of leaked material: Evacuate from the contaminated area and seek medical assistance immediately.
- Eye contact: Flush with clean water for at least 15 minutes and seek medical assistance immediately.
- Skin contact: Wash the contact area thoroughly with soap and clean water and seek medical assistance immediately.
- Ingestion: Induce vomiting and seek immediate medical assistance.
- Do not move the battery system if it is connected to an external expansion module.

If you need to replace or add a battery, please contact the after-sales service center.

**CAUTION**

Risk of battery system failure or life cycle reduction.

Before Connecting

Please check the product and packing list after unpacking. If the product is damaged or parts are missing, please contact the local dealer.

Before installation, make sure that the grid is disconnected and the battery is switched off.

Do not invert the positive and negative cables and ensure there is no short circuit to the external device.

It is prohibited to connect the battery to AC power directly.

The battery system must be properly grounded and the resistance must be less than 1Ω .

Ensure that the electrical parameters of the battery system are compatible with the respective equipment.

Keep the battery away from water and fire.

During Use

If the battery system needs to be moved or repaired, the power must be disconnected and the battery must be switched off.

It is prohibited to connect different types of batteries.

It is prohibited to connect the battery to incompatible or faulty inverters.

It is prohibited to disassemble the battery (to avoid the warranty sticker being removed or damaged).

In case of fire, only a dry powder fire extinguisher must be used, foam extinguishers are prohibited.

Please do not open, repair or disassemble batteries; this is reserved for Dyness staff or authorized personnel. We do not take any responsibility caused by violation of safety operation or equipment safety standards.

Maintenance

Please read the user manual carefully.

If batteries are stored for a long time, it is required to charge them every 10~12 months, and the SOC should be no less than 50%.

Do not expose cables outside.

All battery terminals must be disconnected for maintenance.

Please contact the supplier within 24 hours if there is something abnormal.

Warranty claims are excluded for direct or indirect damage due to items above.

1 Introduction

Brief Introduction

STACK100 is a high-voltage battery storage system based on lithium iron phosphate batteries, and it is one of the new energy storage products developed and produced by Dyness. It can be used to support reliable power for various types of equipment and systems. STACK100 is especially suitable for application scenes of high power, limited installation space, restricted load-bearing and long cycle life.

Product Properties

- The entire module is non-toxic, non-polluting and environmentally friendly.
- Anode material is made from LiFePO_4 with safety performance and long cycle life.
- The Battery Management System (BMS) comes with protective functions including over-discharge, over-charge, over-current and high/low temperature.
- The system can automatically manage the charge and discharge state and balance the current and voltage of each cell.
- Flexible configuration, multiple battery modules can be connected in series for expanding voltage and capacity.
- 1C discharge, built-in air-cooling system.
- Each PACK has an independent fire extinguishing device.
- The module has less self-consumption, up to 10~12 months without charging; no memory effect, excellent performance of shallow charge and discharge.
- Working temperature range is from -20 to $+50^\circ\text{C}$, with excellent discharge performance and cycle life.
- Small size and lightweight, standard module is easy to install and maintain.

Product identity definition

DYNESS		SN: 											
	STACK 100-3S	STACK 100-4S	STACK 100-5S	STACK 100-6S	STACK 100-7S	STACK 100-8S	STACK 100-9S	STACK 100-10S	STACK 100-11S	STACK 100-12S	STACK 100-13S	STACK 100-14S	STACK 100-15S
Nominal Energy/kWh	15.36	20.48	25.60	30.72	35.84	40.96	46.08	51.20	56.32	61.44	66.56	71.68	76.80
Nominal Voltage/V	153.6	204.8	256.0	307.2	358.4	409.6	460.8	512.0	563.2	614.4	665.6	716.8	768.0
Nominal Capacity/Ah	100	100	100	100	100	100	100	100	100	100	100	100	100
Max. Charge/Discharge Current/A	100	100	100	100	100	100	100	100	100	100	100	100	100
Charge Temp/°C	0-50	0-50	0-50	0-50	0-50	0-50	0-50	0-50	0-50	0-50	0-50	0-50	0-50
Discharge Temp/°C	-20-50	-20-50	-20-50	-20-50	-20-50	-20-50	-20-50	-20-50	-20-50	-20-50	-20-50	-20-50	-20-50
IP Grade	20	20	20	20	20	20	20	20	20	20	20	20	20
Protective Class	I	I	I	I	I	I	I	I	I	I	I	I	I
	Dyness Digital Energy Technology Co., LTD. Made in China												





Figure 1-1 Battery energy storage system nameplate and WiFi QR code label





Figure 1-2 Labels with heating function

(Only systems with heating function will be labeled with this label)

- 

The battery voltage is higher than the safe voltage, and direct contact results in an electric shock hazard.
- 

Be careful with your actions and be aware of the dangers.
- 

Read the user manual before use.
- 

Do not dispose of the scrapped batteries with household waste; they must be recycled by professional personnel or institutes.

	After the useful life of the battery, it can continue to be used after being recycled by a professional recycling organization.
	This battery meets European directive requirements.
	Keep away from open flames or other ignition sources.
	Be aware of explosive gas.
	Be aware of battery leakage.
	Heavy objects. Lift with care.
	Keep the battery pack away from children.











DYNESS		IFpP51/161/120[(8S)2S]M/-20+60/90
Product:	Rechargeable Li-ion Battery	<p>WARNING</p> <ul style="list-style-type: none"> * Do not disconnect, disassemble or repair by yourself. * Do not drop, deform, impact, cut or spearing with a sharp object. * Do not place near open flame or incinerate. * Do not sit or put heavy things on the battery. * Keep away from moisture or liquid. * Keep out of reach of children, animals or insects. * Contact the supplier within 24 hours if anything wrong.
Module:	S51100	
Nominal Voltage:	51.2Vdc	
Rated Energy/Capacity:	5.12kWh/100Ah	
Charge Voltage:	57.6V	
Protection Degree:	IP20	
Max. Charge Current:	100A	
Max. Discharge Current:	100A	
Series Number:	□	
         		
Dy Ness Digital Energy Technology Co., LTD.		

Figure 1-2 Battery module label

2 Product specifications

System Performance Parameter

Table 2-1 Parameters of the STACK100 system

Model	STACK 100-3s	STACK 100-4s	STACK 100-5s	STACK 100-6s	STACK 100-7s
Module Voltage/Capacity	51.2V/100A h	51.2V/10 0Ah	51.2V/10 0Ah	51.2V/100 Ah	51.2V/100 Ah
System Modules Serial Number	3	4	5	6	7
System Energy Range	15.4kWh	20.5kWh	25.6kWh	30.7kWh	35.8kWh
Operating Voltage	134-175 V	179-233 V	224-292 V	268-350 V	313-408 V
Recommended Charge/Discharge Current	50A (0.5C)	50A (0.5C)	50A (0.5C)	50A (0.5C)	50A (0.5C)
Max.Charge/Discharge Current	100A (1C)	100A (1C)	100A (1C)	100A (1C)	100A (1C)
Peak Discharge Current(2min 25°C)	125A (1.25C)	125A (1.25C)	125A (1.25C)	125A (1.25C)	125A (1.25C)
Depth of Discharge	95%	95%	95%	95%	95%
Communication	CAN/ RS485	CAN/ RS485	CAN/ RS485	CAN/ RS485	CAN/ RS485
Cycle Life ^[1]	≥8000 cycles	≥8000 cycles	≥8000 cycles	≥8000 cycles	≥8000 cycles
Single Module Weight	47Kg	47Kg	47Kg	47Kg	47Kg
Single Cluster Dimension[W*D*H]	591*390*63 4mm	591*390* 768mm	591*390* 901mm	591*390* 1035mm	591*390* 1168mm
Charging Temp. Range	0~50°C	0~50°C	0~50°C	0~50°C	0~50°C
Discharging Temp. Range	-20~50°C	-20~50°C	-20~50°C	-20~50°C	-20~50°C
Protection Level	IP20	IP20	IP20	IP20	IP20
Fire Protection System	Aerosol fire extinguisher				
Noise	≤ 55 dB				
Installation method	Stack type				
Cooling method	Forced wind cooling				
WIFI Module	Built-in WIFI module; APP OTA function				

Certification & Safety Standard	CE,EMC/CE,RED/62619/63056/62477/62040/UN38.3
Compatible Inverters	Goodwe/Solis/Deye/Solplanet/Solinteg/Sunways/Hoymiles/SAJ/Sinexcel/Growatt/ATESS/Megarevo/Sineng etc

Model	STACK 100-8s	STACK 100-9s	STACK 100-10s	STACK 100-11s	STACK 100-12s
Module Voltage/Capacity	51.2V/ 100Ah	51.2V/ 100Ah	51.2V/ 100Ah	51.2V/ 100Ah	51.2V/ 100Ah
System Modules Serial Number	8	9	10	11	12
System Energy Range	41kWh	46.1kWh	51.2kWh	56.3kWh	61.4kWh
Operating Voltage	358-467V	403-525 V	448-584 V	492-642 V	537-700 V
Recommended Charge/Discharge Current	50A (0.5C)	50A (0.5C)	50A (0.5C)	50A (0.5C)	50A (0.5C)
Max.Charge/Discharge Current	100A (1C)	100A (1C)	100A (1C)	100A (1C)	100A (1C)
Peak Discharge Current(2min 25°C)	125A (1.25C)	125A (1.25C)	125A (1.25C)	125A (1.25C)	125A (1.25C)
Depth of Discharge	95%	95%	95%	95%	95%
Communication	CAN/ RS485	CAN/ RS485	CAN/ RS485	CAN/ RS485	CAN/ RS485
Cycle Life ^[1]	≥8000 cycles	≥8000 cycles	≥8000 cycles	≥8000 cycles	≥8000 cycles
Single Module Weight	47Kg	47Kg	47Kg	47Kg	47Kg
Single Cluster Dimension[W*D*H]	591*390*1302mm	591*390*1435mm	591*390*1569mm	591*390*1702mm	591*390*1836mm
Charging Temp. Range	0~50°C	0~50°C	0~50°C	0~50°C	0~50°C
Discharging Temp. Range	-20~50°C	-20~50°C	-20~50°C	-20~50°C	-20~50°C
Protection Level	IP20	IP20	IP20	IP20	IP20
Fire Protection System	Aerosol fire extinguisher				

Noise	≤ 55 dB
Installation method	Stack type
Cooling method	Forced wind cooling
WIFI Module	Built-in WIFI module; APP OTA function
Certification & Safety Standard	CE,EMC/CE,RED/62619/63056/62477/62040/UN38.3
Compatible Inverters	Goodwe/Solis/Deye/Solplanet/Solinteg/Sunways/Hoymiles/SAJ/Sinexcel/Growatt/ATESS/Megarevo/Sineng etc

Model	STACK 100-13s	STACK 100-14s	STACK 100-15s
Module Voltage/Capacity	51.2V/100Ah	51.2V/100Ah	51.2V/100Ah
System Modules Serial Number	13	14	15
System Energy Range	66.6kWh	71.7kWh	76.8kWh
Operating Voltage	582-759V	627-818V	672-876V
Recommended Charge/Discharge Current	50A (0.5C)	50A (0.5C)	50A (0.5C)
Max.Charge/Discharge Current	100A (1C)	100A (1C)	100A(1C)
Peak Discharge Current (2min 25°C)	125A (1.25C)	125A(1.25C)	125A(1.25C)
Depth of Discharge	95%	95%	95%
Communication	CAN/ RS485	CAN/ RS485	CAN/ RS485
Cycle Life ^[1]	≥8000 cycles	≥8000 cycles	≥8000 cycles
Single Module Weight	47Kg	47Kg	47Kg
Single Cluster Dimension[W*D*H]	591*390*1969 mm	591*390*2103 mm	591*390*2236 mm
Charging Temp. Range	0~50°C	0~50°C	0~50°C
Discharging Temp. Range	-20~50°C	-20~50°C	-20~50°C
Protection Level	IP20	IP20	IP20

Model	STACK 100-13s	STACK 100-14s	STACK 100-15s
Fire Protection System	Aerosol fire extinguisher		
Noise	≤ 55 dB		
Installation method	Stack type		
Cooling method	Forced wind cooling		
WIFI Module	Built-in WIFI module; APP OTA function		
Certification & Safety Standard	CE,EMC/CE,RED/62619/63056/62477/62040 /UN38.3		
Compatible Inverters	Goodwe/Solis/Deye/Solplanet/Solinteg/Sunways /Hoymiles/SAJ/Sinexcel/Growatt/ATESS/Megarevo /Sineng etc		

[1]Test conditions: 0.2C Charging/Discharging, @25°C, 95% DOD.

Battery Module

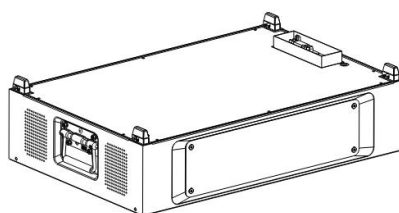

Figure 2-1 Battery module

Table 2-2 Product parameters

Module name	S51100
Cell technology	Li-ion (LFP)
Battery module capacity (kWh)	5.12
Battery module voltage (V/DC)	51.2
Battery module capacity (Ah)	100
Number of battery module cells (pcs)	16
Battery cell capacity (Wh)	320
Battery cell voltage (V/DC)	3.2
Battery cell capacity (Ah)	100
Dimensions (W*D*H, mm)	590*390*133.5
Pollution degree (PD)	II

Module name	S51100
Ambient temperature (°C)	0~50
IP protection class	IP20
Weight (kg)	47

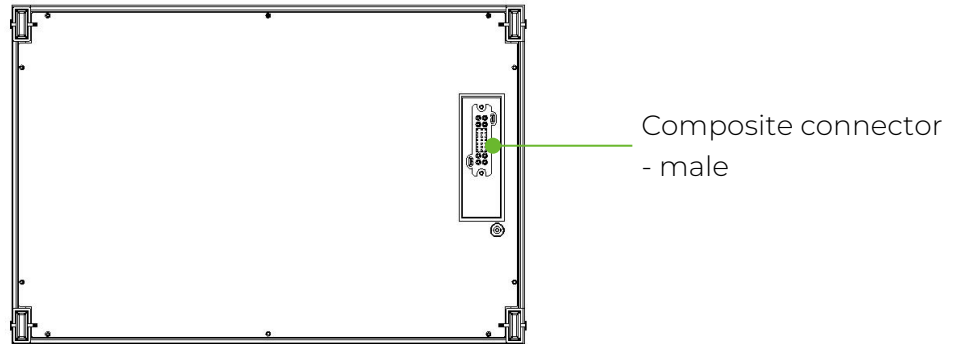

Figure 2-3 S51100 top connector

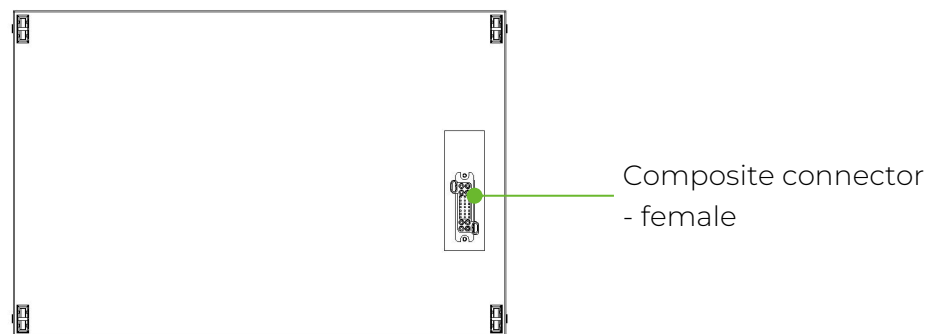

Figure 2-4 S51100 bottom connector

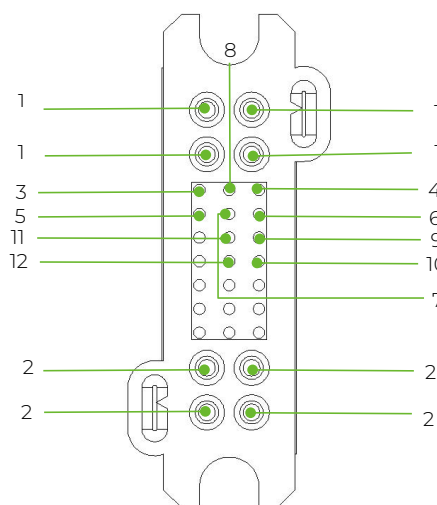

Figure 2-5 Composite connector - male

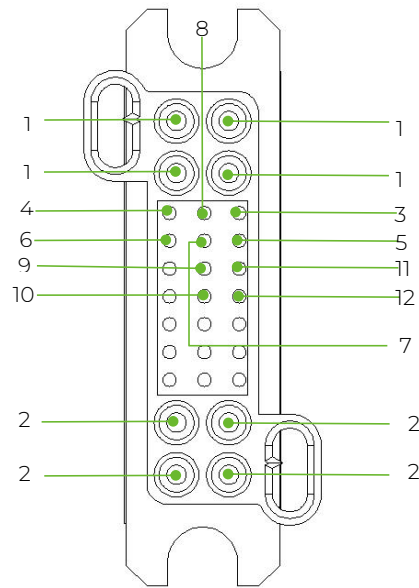

Figure 2-6 Composite connector - female

Table 2-3 Connector definition

Item	Name	Definition
1	Composite connector - male	Battery module output and communication interface
2	Composite connector - female	Battery module output and communication interface

Table 2-4 Port definition

No.	Composite connector - male	Composite connector - female
1	Positive output	Negative output
2	Negative output	Module negative
3	IPC	IPC
4	IPB	IPB
5	IMB	IMB
6	24V-	24V-
7	24V+	24V+
8	IMC	IMC
9	24V-	24V-
10	24V-	24V-
11	24V+	24V+
12	24V+	24V+

Battery controller

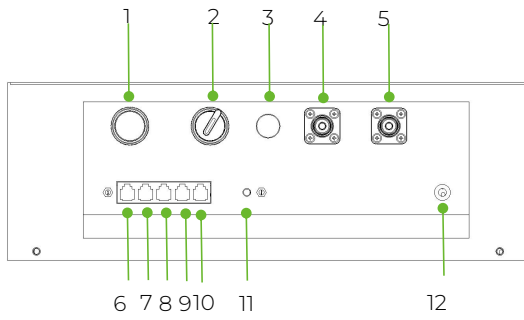

Figure 2-7 BDU right connector

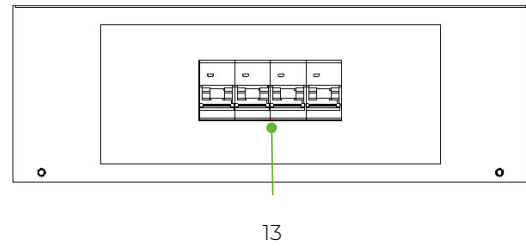

Figure 2-8 BDU left connector

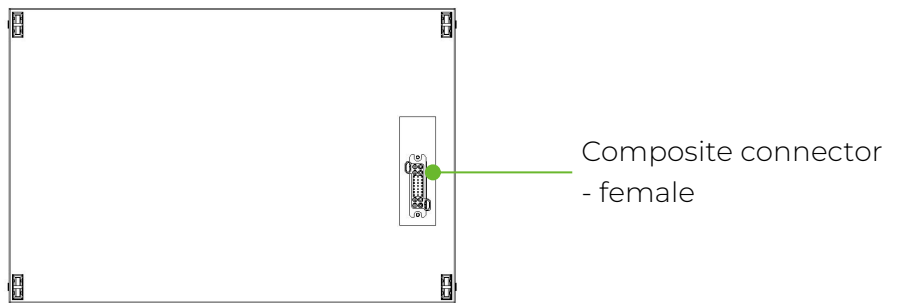

Figure 2-9 BDU bottom connector

Table 2-5 Connector definition

Item	Name	Definition
1	Power Wake Button	Long press this button to start the battery system
2	Power On switch	Turn on the switch to power the BMS system
3	WiFi antenna	Receiving and sending WiFi signals
4	External negative female	Connect battery system to inverter negative terminal
5	External positive socket	Connect battery system to inverter positive terminal
6	TCP/IP	Communication for Ethernet protocol
7	Inverter CAN/RS485	RJ45 communication port between battery system and inverter
8	Inverter CAN/RS485	RJ45 communication port between battery system and inverter
9	Parallel in	Parallel communication connection of multi cluster systems
10	Parallel out	Parallel communication connection of multi cluster systems
11	WiFi antenna	Receiving and sending WiFi signals
12	Grounding	Shell ground connection
13	DC breaker	The master switch of the battery system, you must switch it on before switching on the Power On and Power WAKE switches; short circuit protection

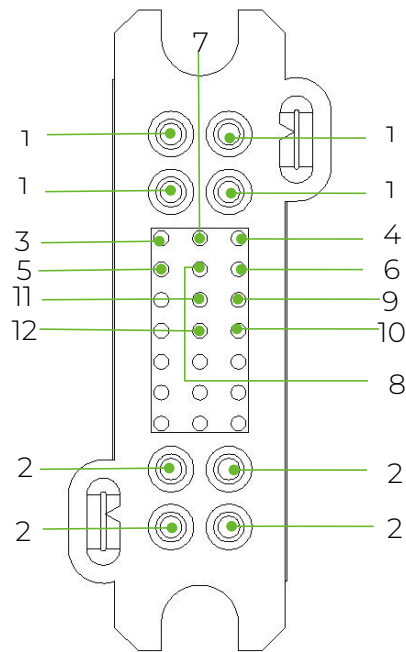

Figure 2-10 Power On switch

Table 2-6 Port definition

No.	Definition
1	Positive output
2	Negative output
3	IPC
4	IPB
5	IMB
6	24V-
7	IMC
8	24V+
9	24V-
10	24V-
11	24V+
12	24V+

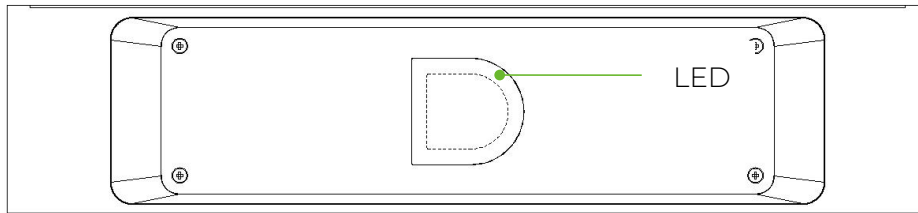









Figure 2-11 BDU front view

Table 2-7 LED status indicators

LED status	Information
	SOC 50%
	SOC 100%
Current SOC increases to 100% ,then cycles 	Charge
Drop from current SOC to 0%, then loop 	Discharge
Green light flashing(Current SOC) 	Standby
Yellow light flashing 	Communication failure between batteries or communication failure between lamp board and BMS.No inverter communication cable connected after startup.
Red light on 	System protection



DANGER

Ensure ON/OFF switch is turned on before waking up the battery. Otherwise it will affect the auto test process and cause danger.

DO NOT switch off the ON/OFF switch during normal operation, only in emergencies. Otherwise it will cause the battery current to surge.



CAUTION

If the DC breaker trips because of over-current or short circuit, you must wait for 30 minutes to switch it on again, otherwise it may cause damage to the breaker.

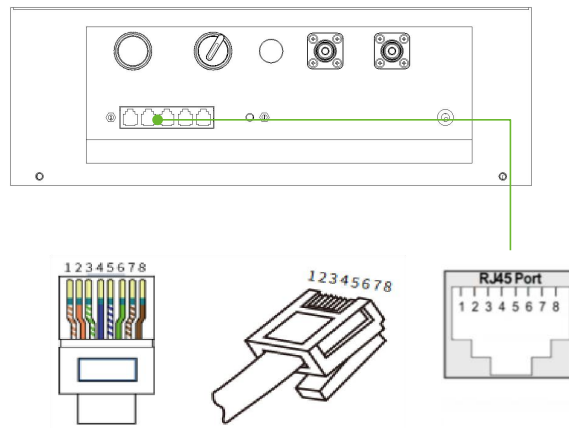

Figure 2-12 “Inverter CAN/RS485” port pins

Table 2-8 Definition of “Inverter CAN/RS485” port pins

PIN	Color	Definition
PIN1	Orange/White	485_B
PIN2	Orange	485_A
PIN3	Green/White	Reserved
PIN4	Blue	CANH
PIN5	Blue/White	CANL
PIN6	Green	NC
PIN7	Brown/White	NC
PIN8	Brown	NC

3 Installation and Configuration

Environmental Requirements



DANGER

Cleanliness

The battery system has high voltage connectors. The environmental conditions will affect the isolation of the system.

Before installation and switch-on, dust and swarf must be removed to keep the system clean. The environment must be dust-proof to a certain extent.

Dust and humidity must be regularly checked during continuous operation of the system.

Fire Protection System

Rooms are recommended to be equipped with a fire protection system or fire extinguishers (dry powder fire extinguishers are recommended). The fire protection system should be regularly inspected to ensure normal operation.

Local requirements are important to follow. Please refer to the local requirements for the use and maintenance of fire protection equipment.

Recommended but not a must for Dyness warranty.

Grounding System

Make sure that the grounding point for the battery system is stable and reliable before installation. If the battery system is installed in an independent equipment cabin (e.g. container), ensure that the grounding of the cabin is stable and reliable.

The resistance of the grounding system must be $\leq 100\text{m}\Omega$.



CAUTION

Temperature

STACK100system working temperature range: -20°C to $+50^{\circ}\text{C}$; Optimum temperature: 18°C to 30°C ; Exceeding the working temperature range will cause over-temperature/under-temperature alarms or protection of the battery system which may lead to the reduction of cycle lives.

Cooling System

It is essential to equip a cooling system to keep the battery system in a relevant temperature range. Over-temperature/under-temperature alarms or protection of the battery system may lead to the reduction of lifespan.

Heating System

It is essential to equip a heating system to keep the battery system in a relevant temperature range. If the environment is lower than 0°C, the system may be shut down for protection. It is necessary to open the heating system first. Exceeding the working temperature range will cause the battery system over-temperature/under-temperature alarm or protection of the battery system may lead to the reduction of cycle lives.

Installation location precautions



DANGER

Please note that when installing the battery, it should maintain a minimum safety distance of 500mm from surrounding equipment or batteries. It should maintain a minimum safety distance of 30mm from wall. When the battery is operating under conditions of 0.5C or higher and the surrounding space is a non-constant temperature environment, the distance between the working surface of the battery fan and another cluster of batteries must be greater than 300mm. When installing manually, the installation distance shown in the figure below must be ensured.

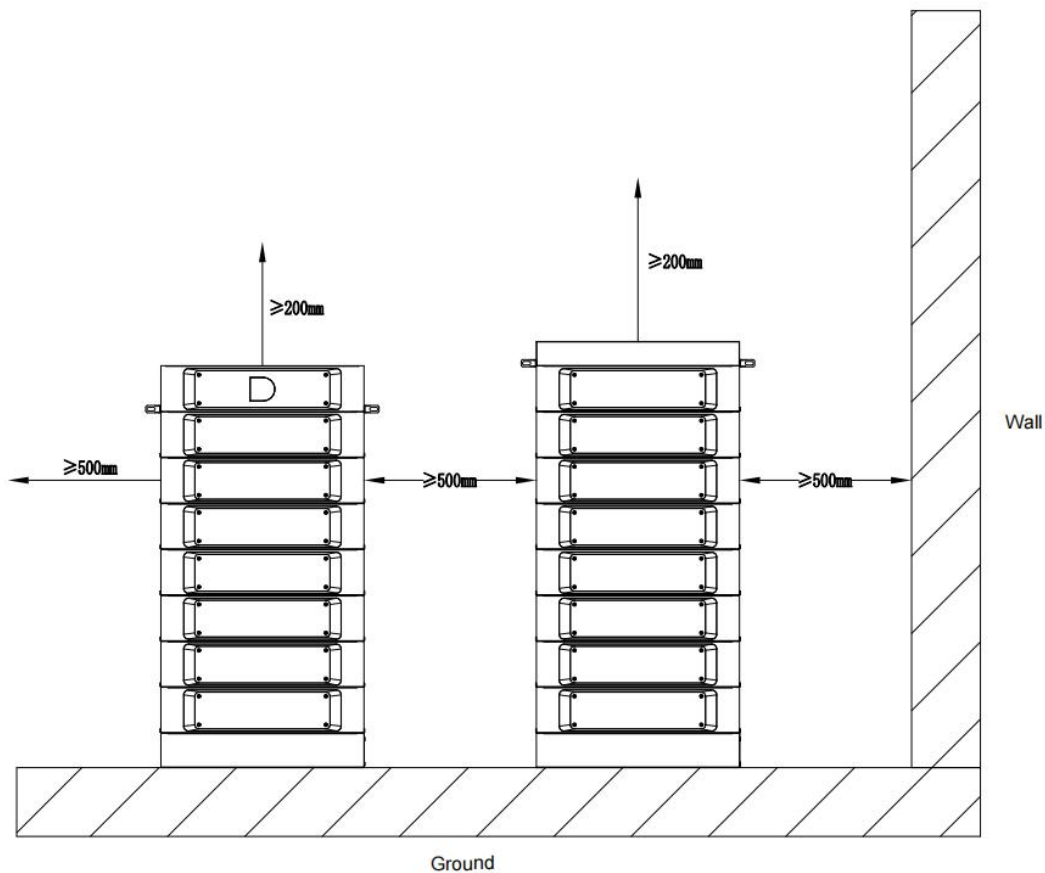

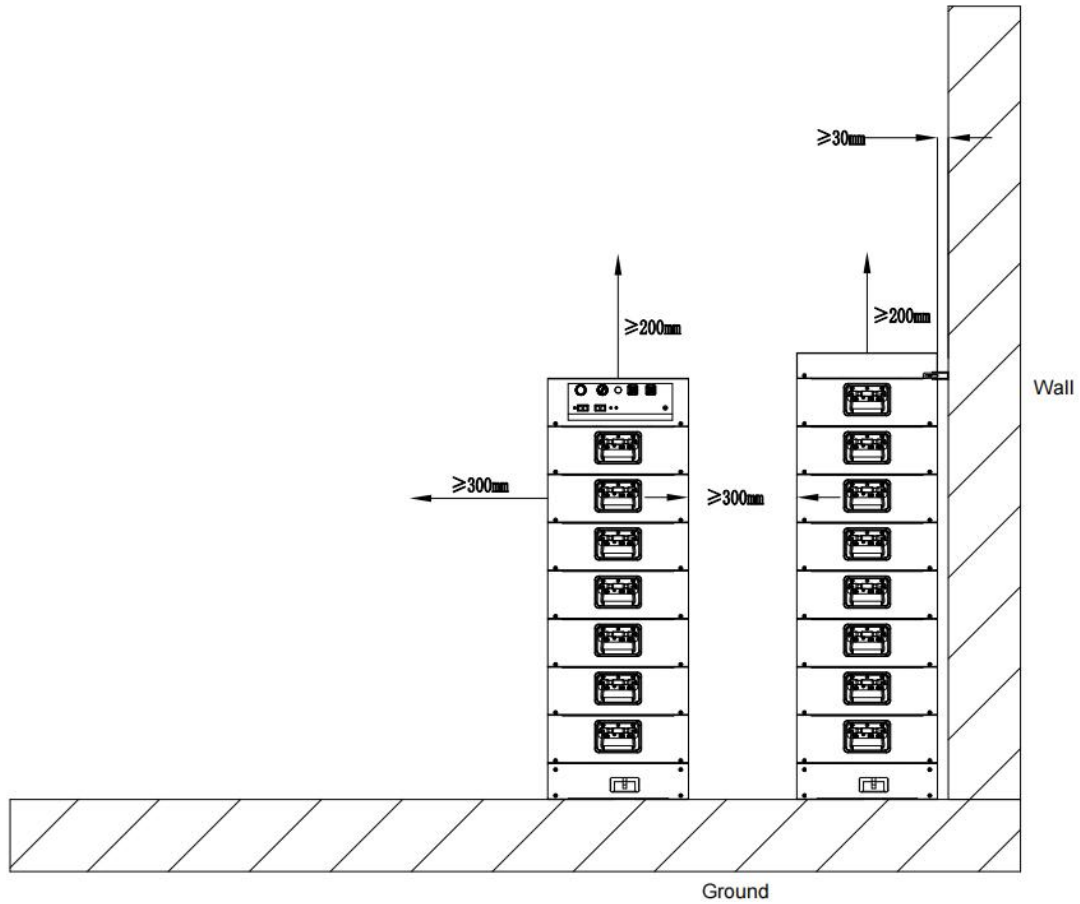

Figure 3-1 Minimum clearance

Note:

- 1.The system should be installed with the help of at least 2 grown-up males.
- 2.If more than 12 of the mare to be configured, It is suggested to divide into two columns. The battery system should be installed indoors, away from flammable and explosive materials.

Tools

The following tools are required to install the battery pack:

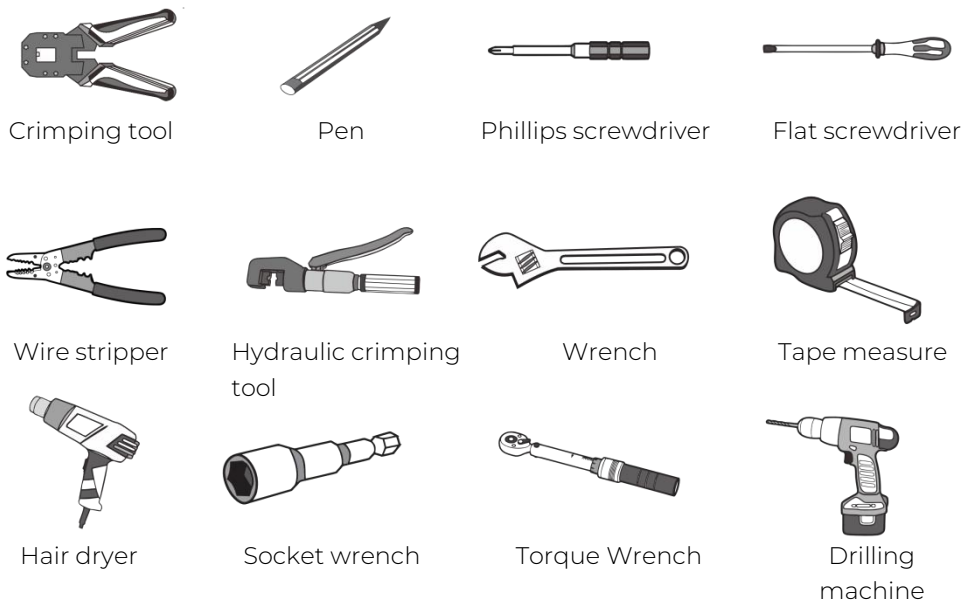

Figure 3-3 Installation tools

Safety Gear

We recommend wearing the following safety gear when working with batteries:



Figure 3-4 Safety gear



Unpacking inspection

- When the equipment arrives at the installation site, unloading should be performed according to rules and regulations, to prevent from being exposed to direct sunlight. The battery should not be installed in direct sunlight. Please refer to Section 3.3.
- Before unpacking, the total number of packages shall be indicated according to the shipping list attached to each package, and all packages shall be checked for good condition.
- Handle with care and protect the surface coating of the goods.





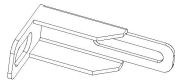

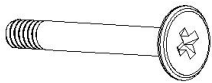
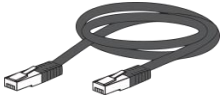
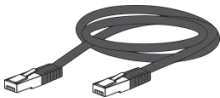
- Upon opening the package, the installation personnel should read the technical documentation, verify the list according to configuration table and packing list and ensure that the goods are complete and intact. If the internal packing is damaged, goods should be examined and recorded in detail.

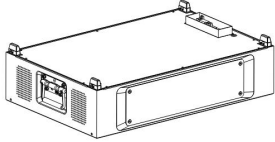

Check the components of the STACK100 Battery System in different capacities

Table 3-1 Scope of delivery

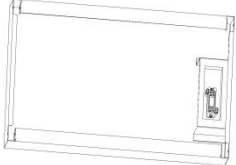
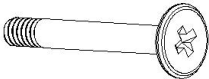
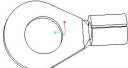
Package	Name	Specifications	Quantity	Image
A	BDU	590*390*133.5mm	1	
	Base	590*390*100mm	1	
	Fixing bracket	To secure with the wall	2	
	Expansion Bolt	M6*80	2	
	Expansion Bolt	M12*100	4	
	CAN resistor	RJ45-CAN-120, Pin4&5	1	
	Flat head Phillips screws	M5*30	4	
	Terminal	OT4-6	2	
	Communication cable to inverter	b/L2000mm/RJ45 plug at both sides, CAN	1	
	Communication cable to inverter	b/L2000mm/RJ45 plug at both sides, RS485	1	

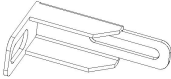
Package	Name	Specifications	Quantity	Image
	Power cable-negative	Positive cable, UL10269 4AWG , red, 2050mm	1	
	Power cable-positive	Negative cable,UL10269 4AWG, black, 2050mm	1	
	*Power cable-positive	Positive cable 8AWG, red, 2m	1	
	*Power cable-negative	Negative cable 8AWG, black, 2m	1	
	*Power cable-positive	Positive cable 10AWG, red, 2m	1	
	*Power cable-negative	Negative cable 10AWG, black, 2m	1	
User Manual	User Manual		1	
Warranty Card	\		1	
Letter to customer	\		1	
Packing list	\		1	

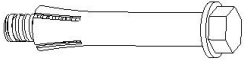
Package	Name	Specifications	Quantity	Image
B	S51100	590*390*133.5mm	1	
	Flat head Phillips screws	M5*30	4	
	Packing list	\	1	
C (optional)	Expansion Base	590*390*100mm	1	
	Expansion Cover	590*390*70mm	1	
	Flat head Phillips screws	M5*30	4	
	OT terminal	OT4-6	2	
	Communication parallel cable	Communication between two cluster	1	
	Series cable	Two clusters in series UL10269 4AWG	2	
	Fixing bracket	fix to the wall	2	

Package	Name	Specifications	Quantity	Image
	Expansion Bolt	M6*80	2	
	Expansion Bolt	M12*100	4	
	Packing list	\	1	

*8AWG and 10AWG power cables are requirements for the European sales region.

Table 3-2 Scope of delivery

Model	Battery system capacity	Configuration	
STACK100-3S	15.4kWh	A+B*3	
STACK100-4S	20.5kWh	A+B*4	
STACK100-5S	25.6kWh	A+B*5	
STACK100-6S	30.7kWh	A+B*6	
STACK100-7S	35.8kWh	A+B*7	
STACK100-8S	41kWh	A+B*8	
STACK100-9S	46.1kWh	A+B*9	
STACK100-10S	51.2kWh	A+B*10	
STACK100-11S	56.3kWh	A+B*11	
STACK100-12S	61.4kWh	A+B*12	
STACK100-13S	66.6kWh	A+B*13	A+B*13+C
			(Recommend two columns)
STACK100-14S	71.7kWh	A+B*14	A+B*14+C
			(Recommend two columns)
STACK100-15S	76.8kWh	A+B*15	A+B*15+C
			(Recommend two columns)

Equipment installation

Note:

1. If more than 12 battery modules are to be installed, you are advised to install them in two columns.
2. One battery column (15 Battery + 1 BDU) is about 2236 mm in height. Please maintain a clearance of 200mm above the CM. Namely, ensure that the distance between the floor and the ceiling is greater than 2436 mm for the convenience of installation and better heat dissipation. If the height is not enough, you are advised to install them in two columns.
3. The system should be installed with the help of at least 2 grown-up males.
4. If the use of a conduit is required, please install the bushing to the reserved hole before installing the expansion screw.

Installation Preparation

1. Make sure that the environment meets all technical requirements.
2. Prepare equipment and tools for installation.
3. Confirm that the DC breaker is in the OFF position.

Mechanical Installation



DANGER

The battery system is a high-voltage DC system. Ensure that installation area of STACK100 is stable and reliable.

Please confirm that the battery system is switched off before connecting. Electric shock and damage to the inverter may be caused if the battery is connected directly without being switched off.

Otherwise, the system cannot work properly. The voltage of the battery is too high, please pay attention to self-protection during measurement.

Step 1: Install the battery base.

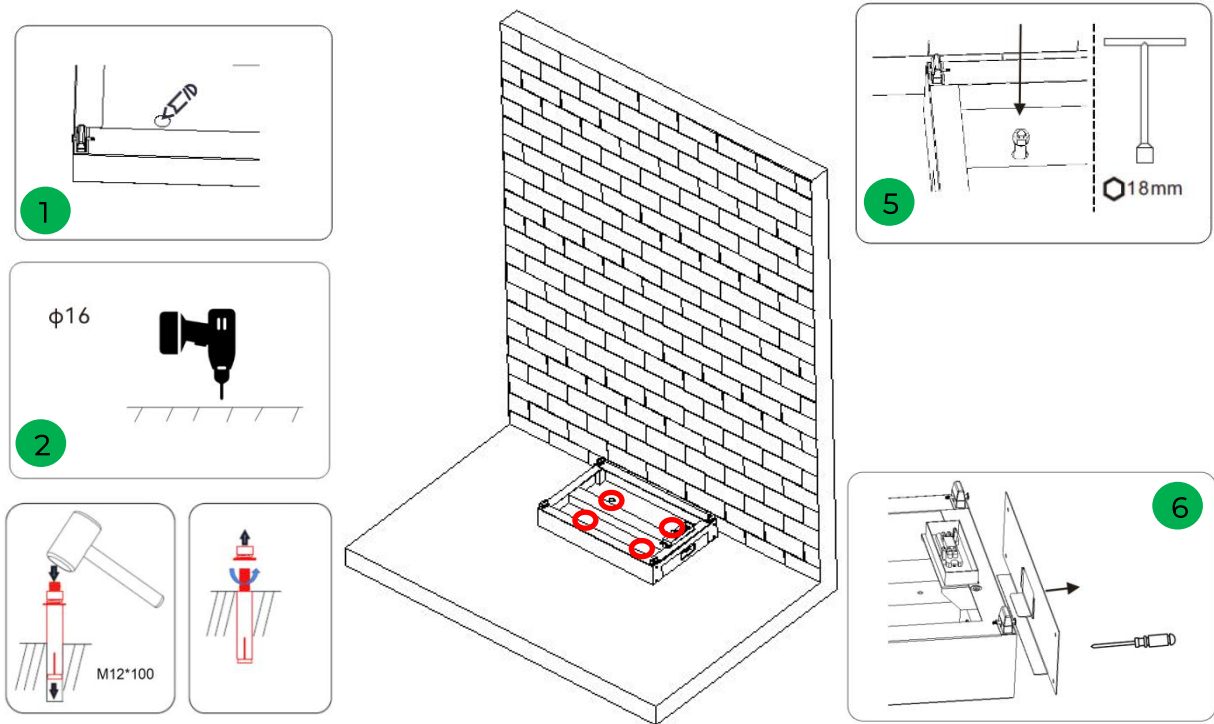

1. Mark the hole positions using a marker.
2. Drill holes at the marked positions to a depth of 95 mm.
3. Knock the expansion screws into the holes (M12x100).
4. Remove the flat washer, the spring washer and the nut. Place the base on the selected position, then install the flat washer, the spring washer and the nut.
5. Tighten the nut to secure the base.
6. When installing in two columns, you need to remove the cover on the side of the base and install the communication line and power line between two columns.

Step 2: Place the Battery Module onto the base, ensuring that the locating pins of the Battery with the locating points on the base.

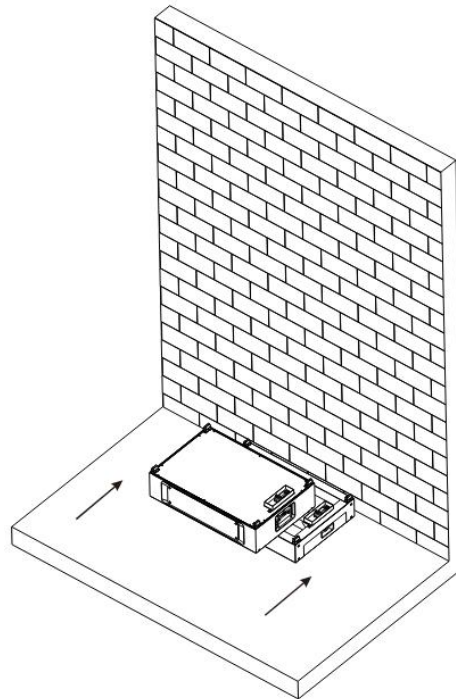

Step 3: Install four M5*30 locking screws on the left and right sides.

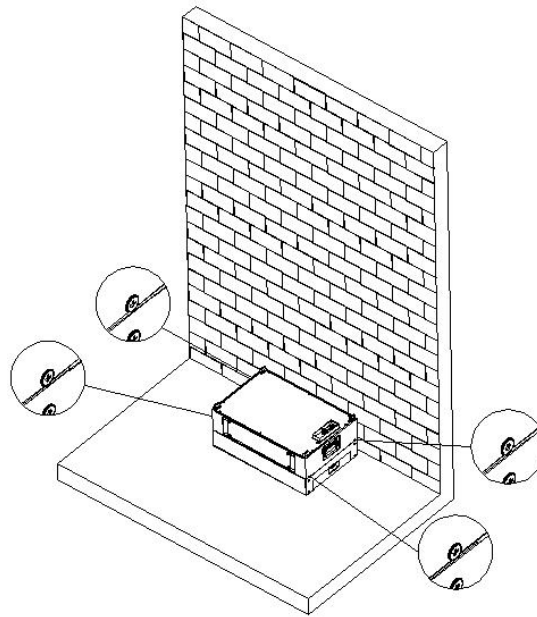
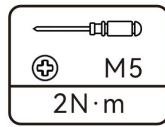

Step 4: Repeat steps 2 and 3 until the required batteries and BDU are installed.

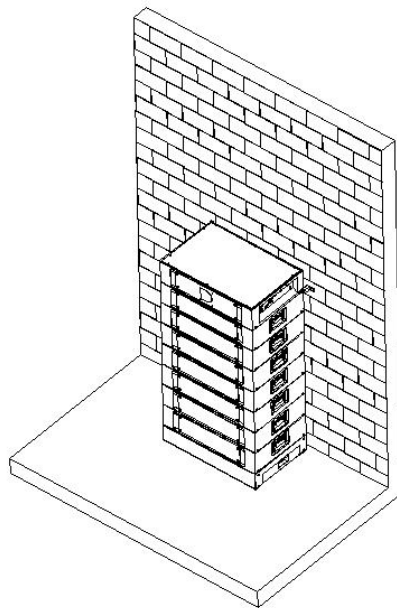

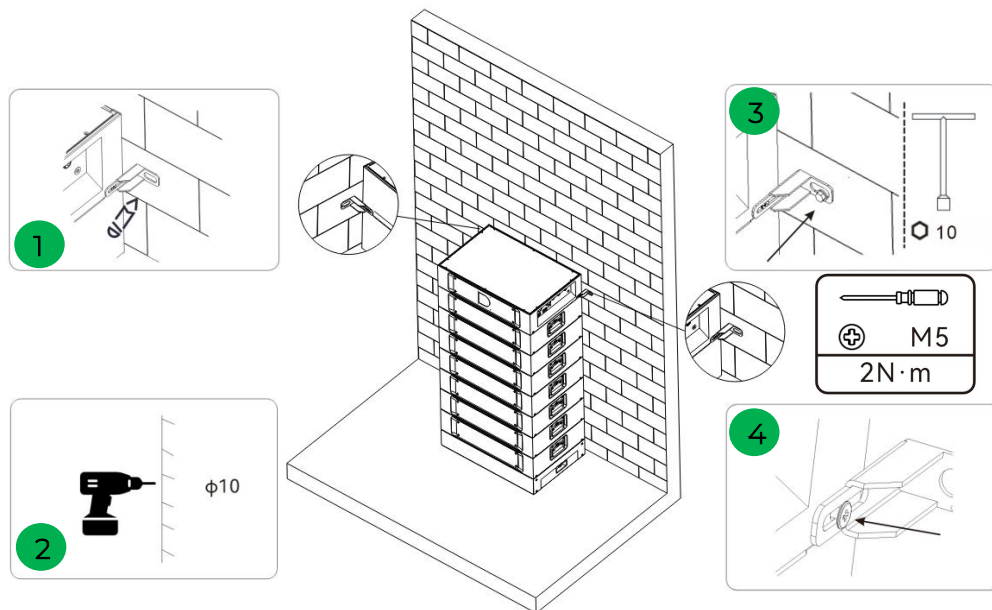
Step 5: Installed hanging ear.

1. Mark the hole positions using a marker.
2. Drill holes at the marked positions to a depth of 90 mm.
3. Hanging ears are installed on the left and right sides respectively and locked to the wall with expansion screws(M6x80).
4. Use two M5*30 screws to fix the left and right Hanging ears to the chassis respectively.

Expansion package installation



TIPS

1. If the number of battery packs in a single cluster is greater than 11, it is recommended to use an expansion pack for installation.
2. After expansion, the standard base becomes an expansion base, and the yellow label needs to be pasted by the customer himself.
3. The operation guide for changing the standard base to an expanded base is attached in Annex 1.

Install according to the minimum distance in Figure 3-1.



DANGER

The Extended cover must be exclusively used with the expansion-labeled base. Stacking with standard Base units is prohibited to prevent circuit interruption.



TIPS

The following illustrations depict the correct and incorrect connection methods.



Expansion cover in conjunction with Expansion Base

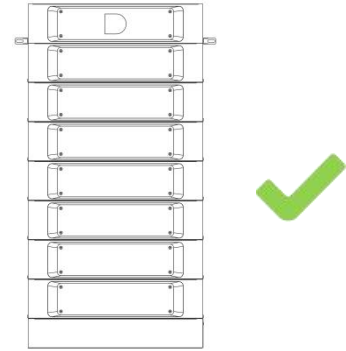
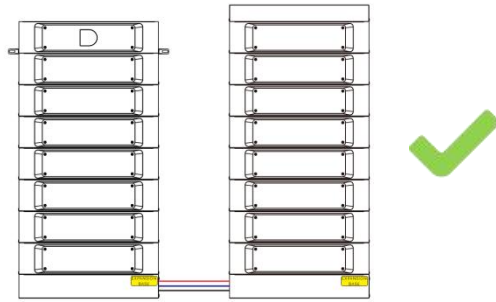

Expansion covers are prohibited from being used with standard bases

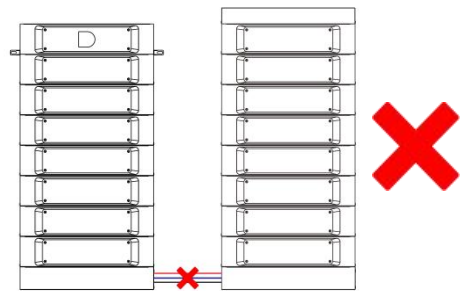
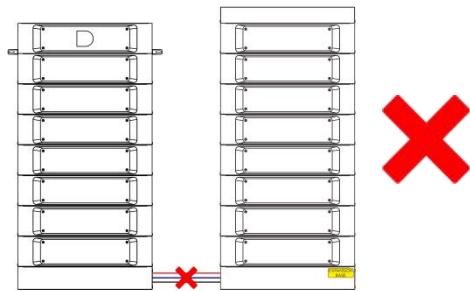
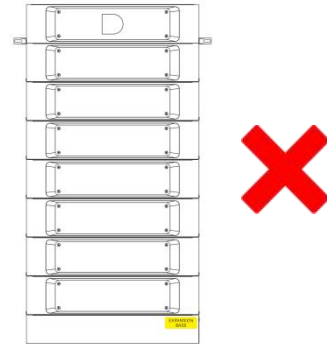
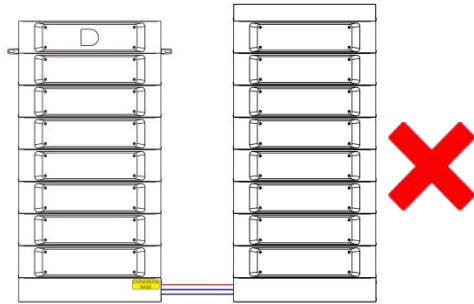

Step 1: Use a Screwdriver to unscrew the right cover of the left and right rows of bases.

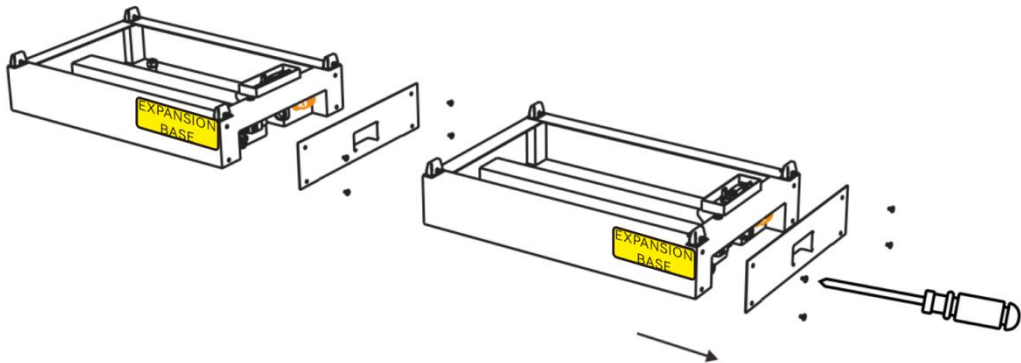

Step 2: Install three cables.

1



2

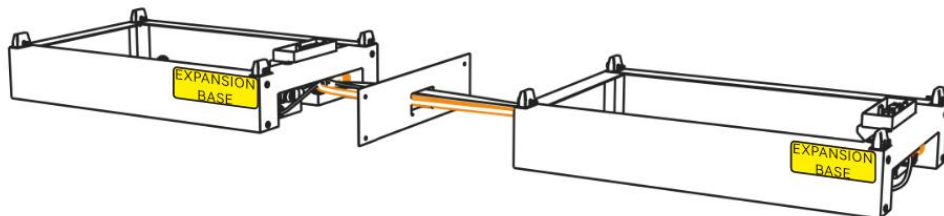

1. Thread the base side cover of the BDU column through the left end of the cable.
2. Pass the right end of the cable through the groove under the expansion package and connect it to the corresponding positive and negative poles and communication ports.

Wiring details:

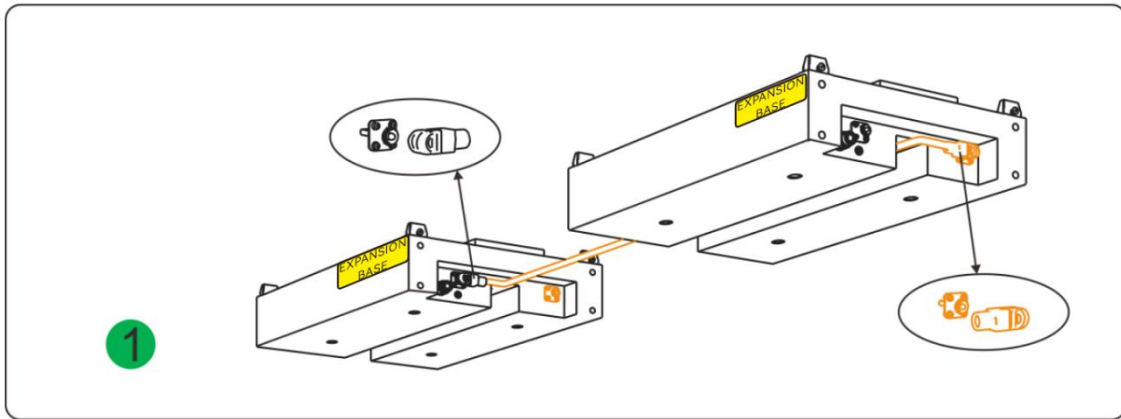

The negative connector of the power line is connected to the negative interface of the main cluster base.

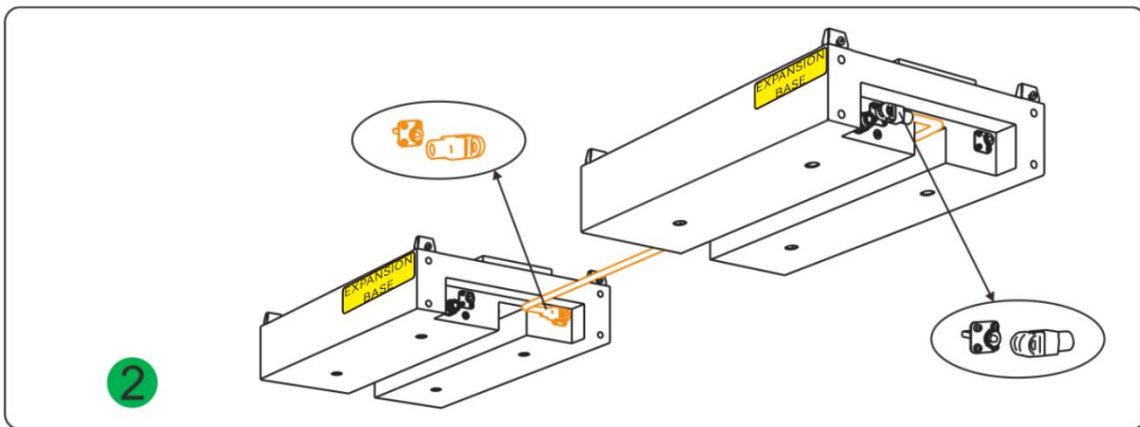

The positive connector of the power line connects the positive interface of the expansion cluster base.

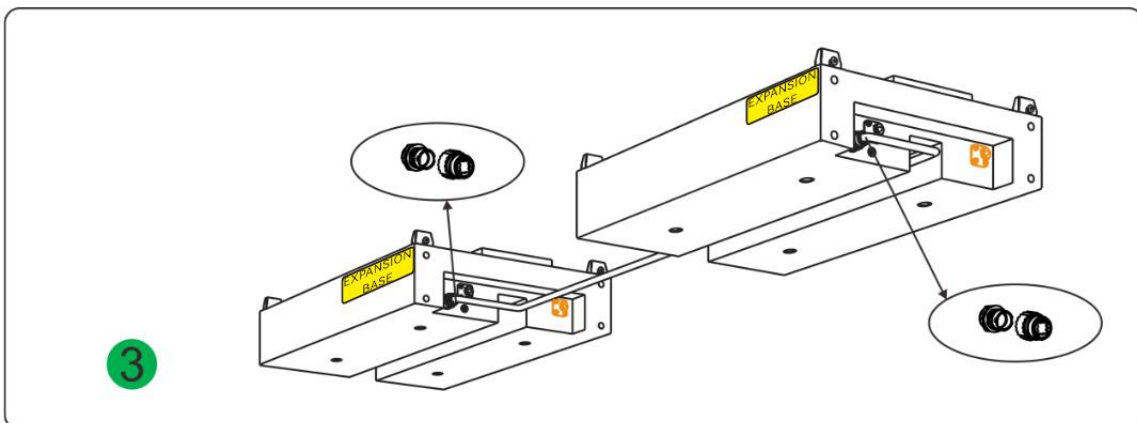

The left end of the communication line is connected to the communication port of the main cluster, and the right end is connected to the communication port of the expansion cluster.

Step 3: Install the battery module according to the above installation steps.

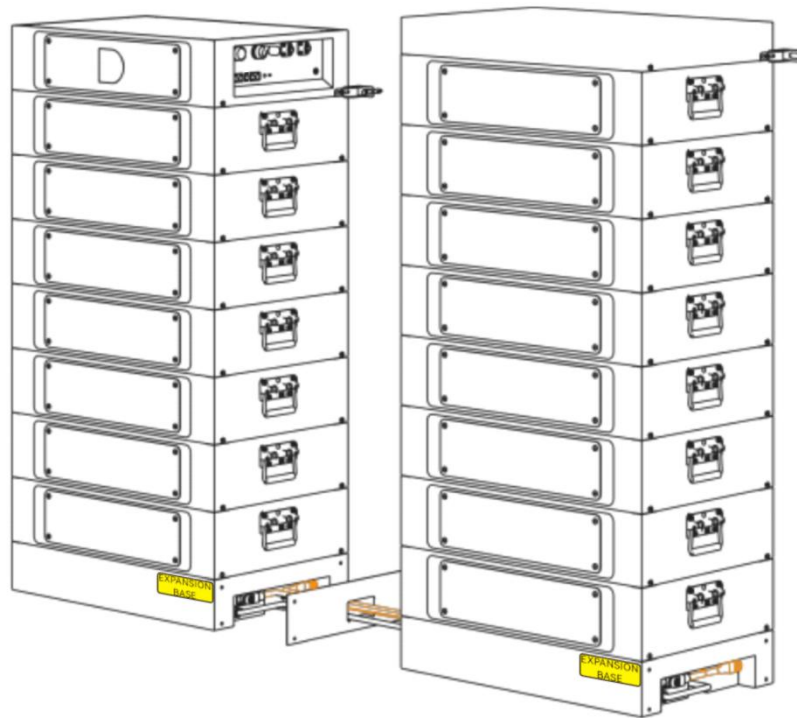

Step 4: Press the "Wake Up" button on the BDU to start up and check if the installation is successful.

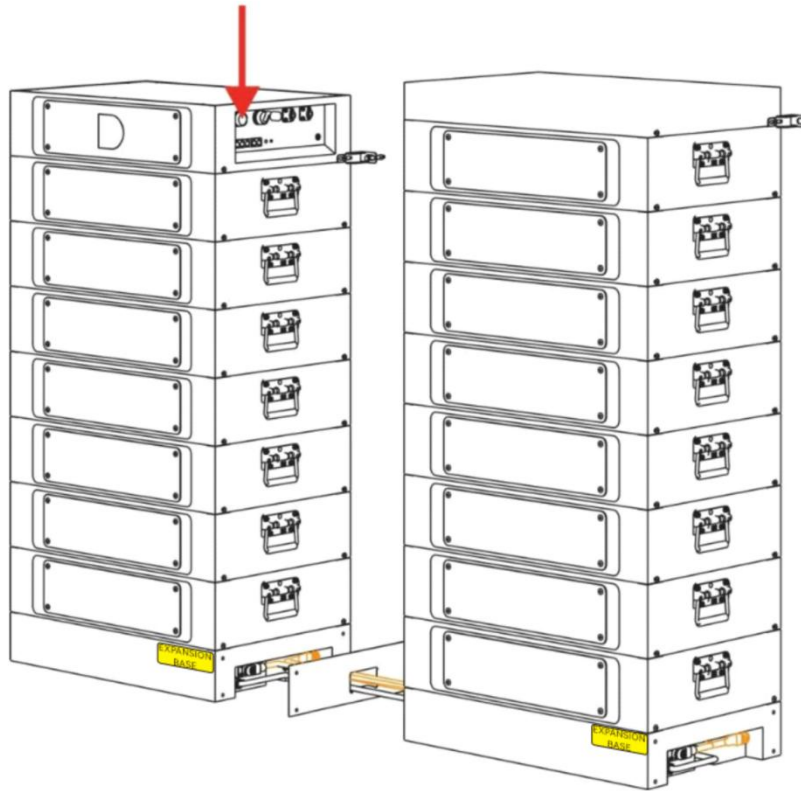

Step 5: After checking the circuit, lock the right cover of the two cluster bases separately.

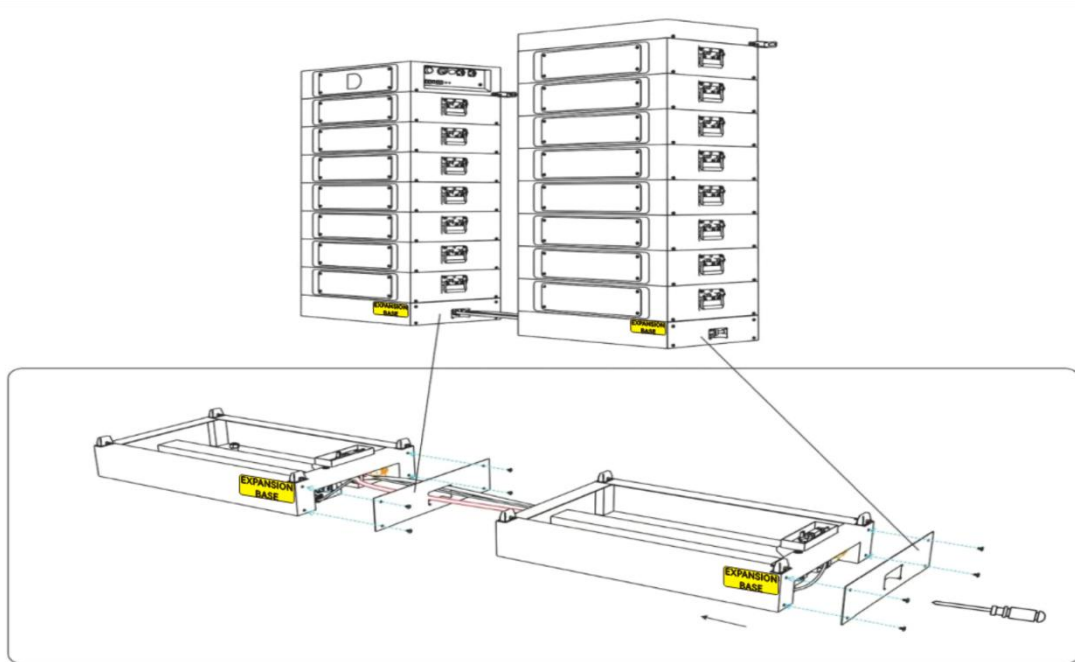

DANGER

The battery system is a high-voltage DC system. Ensure that installation area of STACK100 is stable and reliable.

Please confirm that the battery system is switched off before connecting.

Electric shock and damage to the inverter may be caused if the battery is connected directly without being switched off.

Otherwise, the system cannot work properly. The voltage of the battery is too high, please pay attention to self-protection during measurement.

Battery Capacity Description

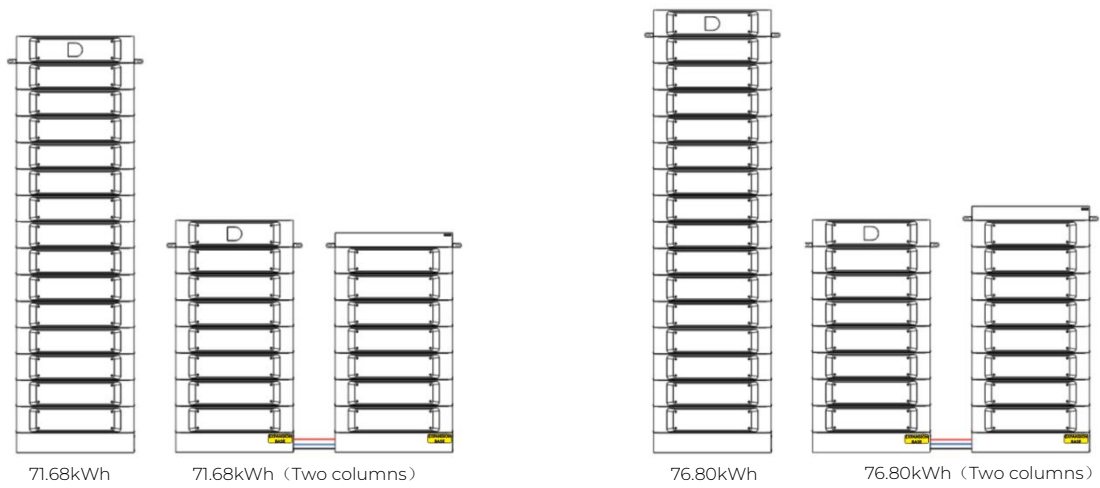
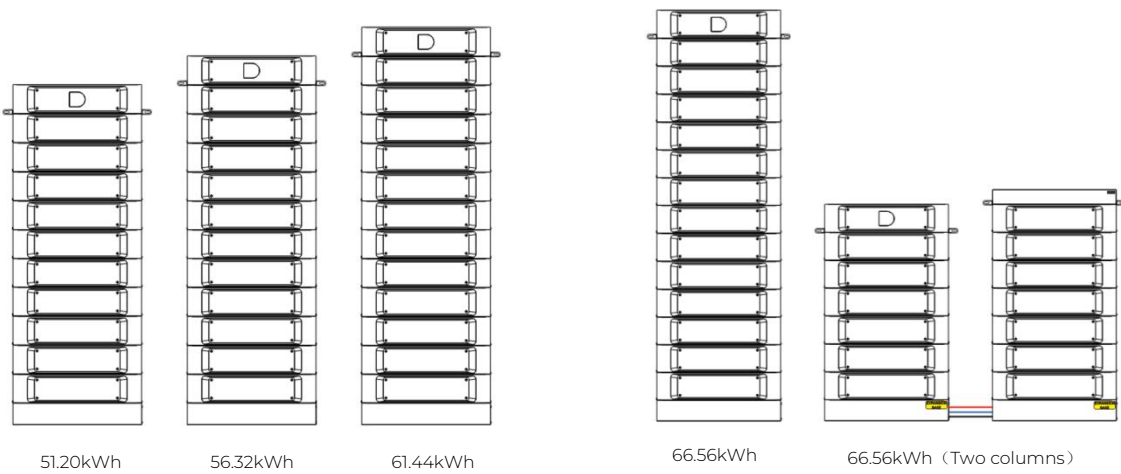
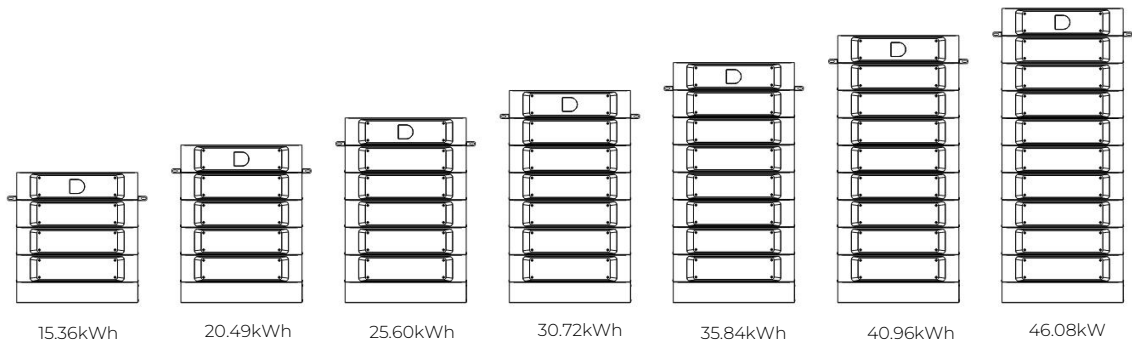

Note:

When configuring the Battery Modules in two columns, please purchase two bases and the extension cables for series connection, which include the power cable, the communication cable .

Electrical installation

Step 1 Electrical installation

After the system installation is completed. There is a touch down point

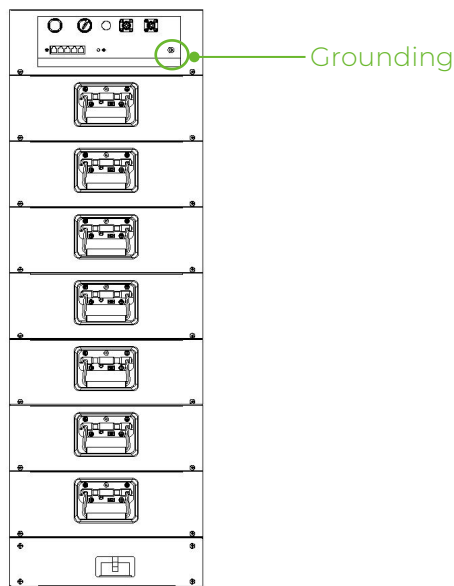

at the top of the BDU, as shown in the figure below:

Step 2 Battery system self-test

1. Switch the DC breaker of the BDU on.

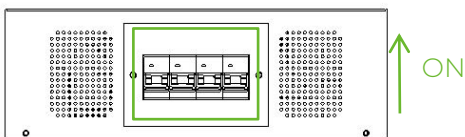

2. Turn the POWER ON knob to ON.

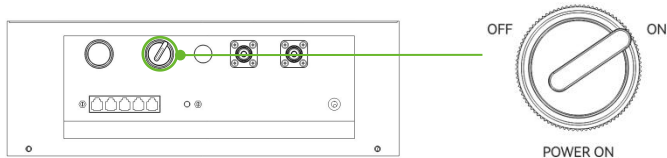

3. Press and hold the WAKE button for approx 15s, battery power on.

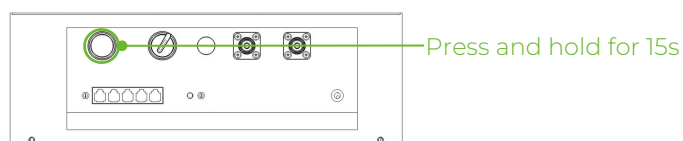

Step 2 Battery system self-test

4. Check the system output voltage.

- Use a multimeter to measure the output voltage on the positive and negative ports of the BDU.
- The output voltage should conform to the Operating Voltage range in Table “P7 Table 2-1 Parameter of the STACK100 system”.

5. Turn the POWER ON knob to OFF, battery shutdown.

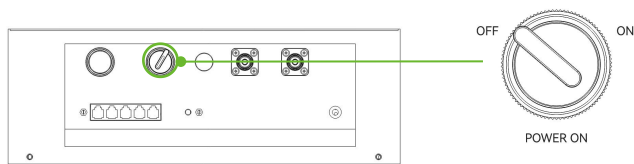

6. Switch the BDU DC BREAKER to OFF position.

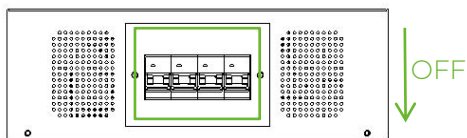

Step 3 Connecting inverter

1. Connect the external power cable to the inverter

If the 2m power cable is not long enough, please find another power cable of the same specification.

There are two sizes of communication cable to connect the inverter, one is cable labeled with RS485, matching Kostal; one is cable labeled with CAN, matching Soils/GDW/Solinteg/Growatt/Sosen/Deye/SINENG/ATESS/SINEXCEL/Solplanet, please use them differently.

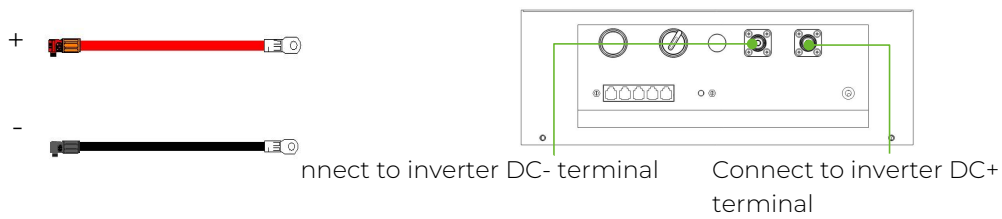

2. Connect the Inverter CAN/RS485 communication cable to the inverter RJ45 CAN/RS485 port.

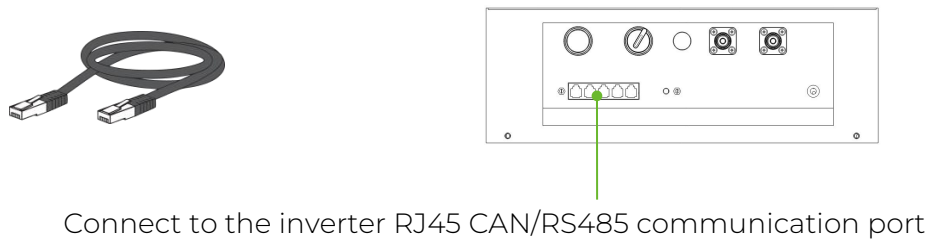

Step 4 Parallel system

Important:

The parallel connection of the STACK100series and all other related work are only allowed by professional and qualified electricians.

The total voltage difference between clusters is less than 20V; SOC of each cluster should be 100% and time interval between newly added cluster and existing cluster should be less than 3 years.

Maximum 12 STACK100clusters are allowed to be connected in parallel.

For parallel operation, the communication cable can only be used with the CAN cable label.Parallel wiring.

The general configuration diagram of the STACK100 in parallel connection is as under.

Take three clusters for example:

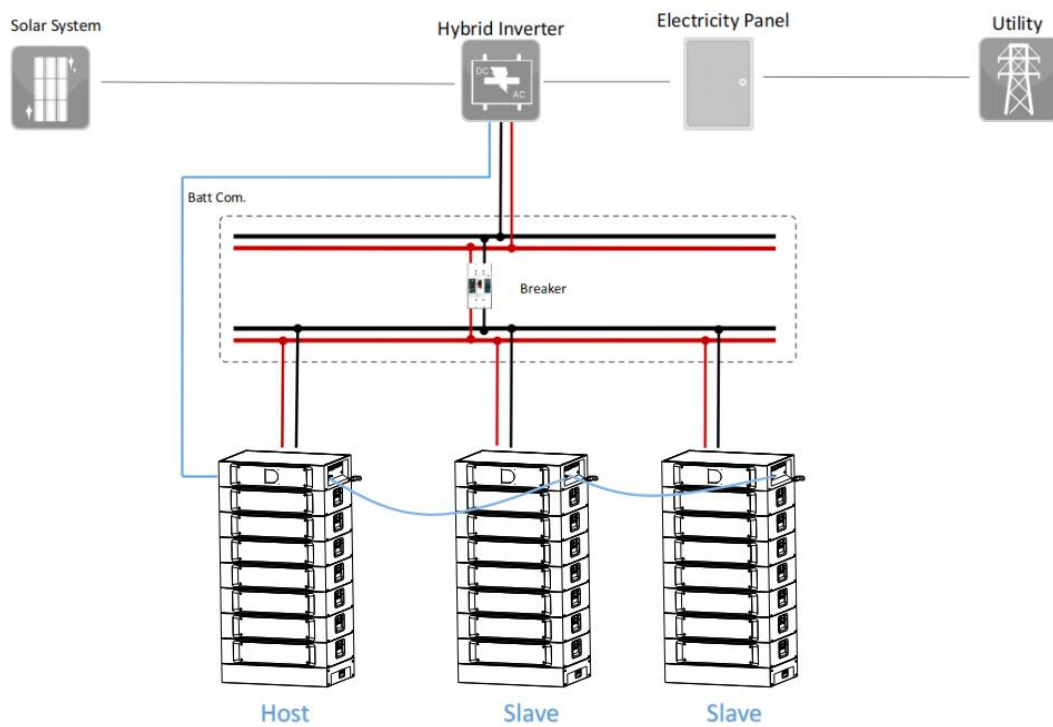
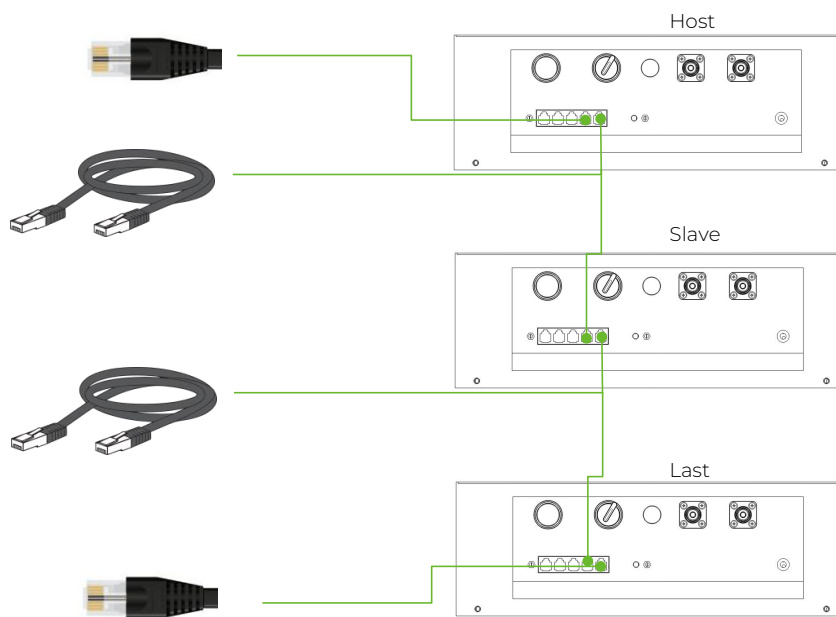

Figure 5-1 The general configuration diagram of the STACK100

Step 4 Parallel system

Communication network cable connection between STACK100 and STACK100:
standard network cable

For multi cluster parallel systems, the communication line connection between clusters is Host's Parallel 2 to the second cluster's(Slave) Parallel 1 and so on. Then connect a 120 Ω CAN resistor to the port of the host parallel 1 and the last slave parallel 2. Ensure the stability of CAN communication.



Communication network cable connection between inverter and
STACK100(Host):

CAN/RS485 of the BDU of STACK100 to the communication port of the inverter.

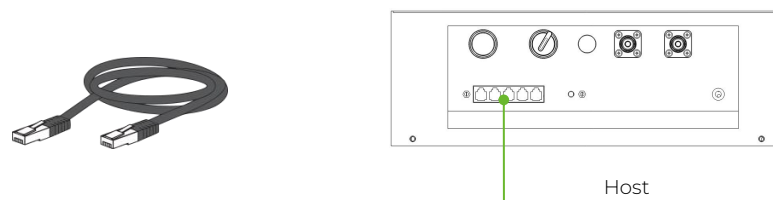

Connect to the inverter RJ45
CAN/RS485 communication port

Step 4 Parallel system

Attention

- The STACK100 in parallel must be of the same model and same capacity.
- During capacity expansion, make sure SOC of each module is 100%.
- Power on sequence of multiple clusters: Start the Slave first, then start the Host last.

App Operation Instruction

- Download the 'Dy Ness' App to get full functionality of your battery from the App Store (iOS devices) or Google Play(Android devices) or scan below QR code.

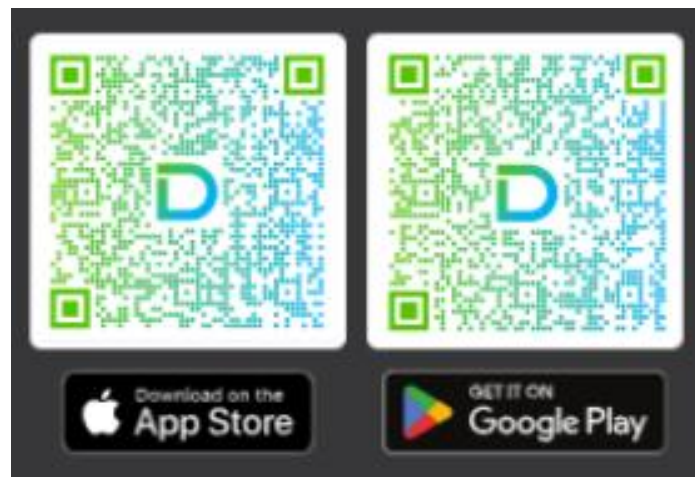

- Registration & Login

Register after the APP is installed, click "Create an account", enter the registration page as below:

- (1) Select "Create an account" on the Dy Ness App login interface.
- (2) Select the current country or region.
- (3) Select the identity "user type" for registering the account, Owner or Partner;

If you are a partner of Dy Ness, you can contact the platform business to obtain your exclusive invitation code to complete account registration.

- (4) Click "Next"

(5) Follow the prompts on the "Create Account" interface to complete the account registration process.

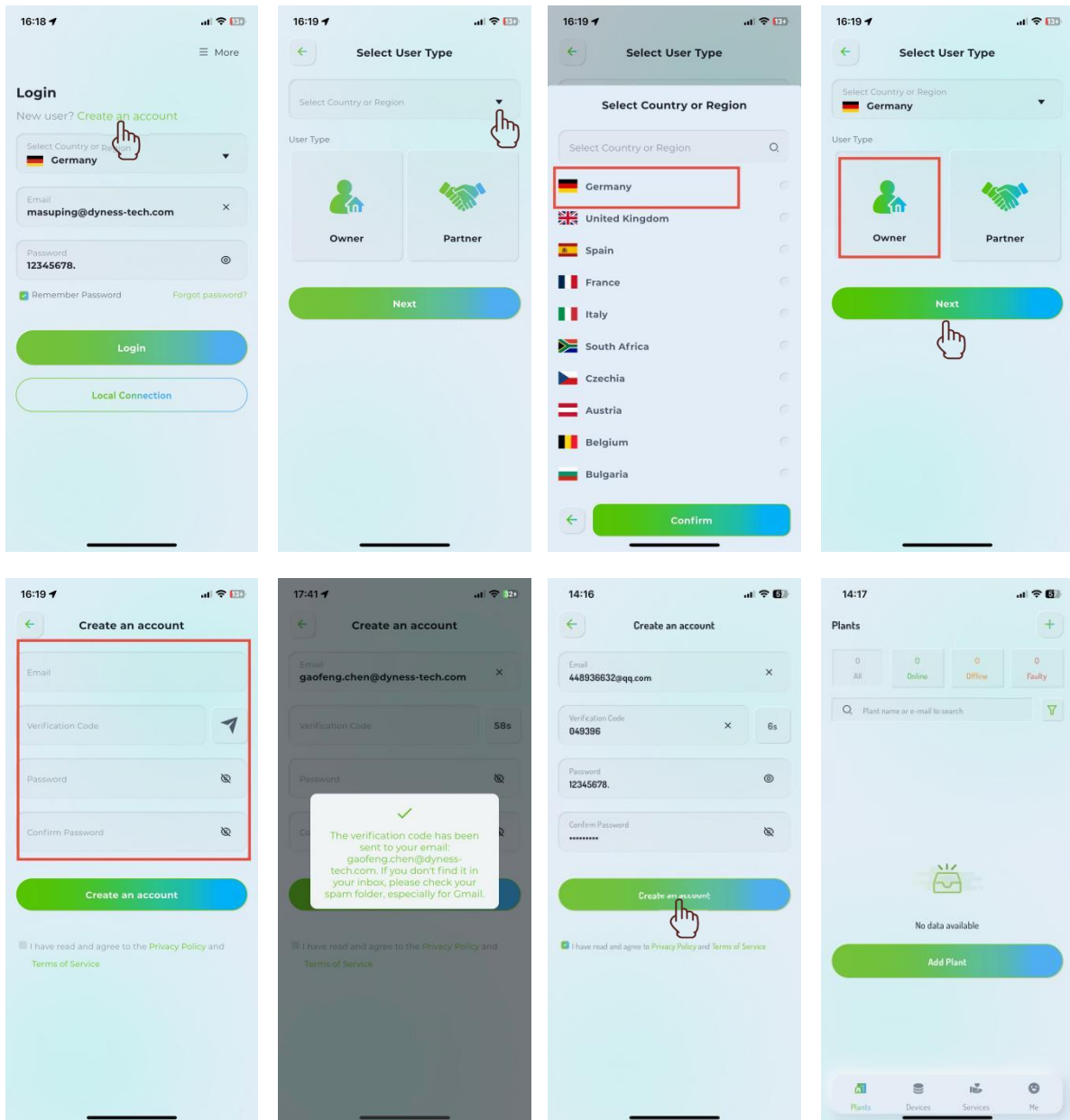

- Create Plants, Add Device and Connect the network

Please login account and Create Plant.

Click "Add Plant" to enter the device selection interface, and select the corresponding device type and model.

There are three Methods to add Device:

Method 1: Add via Bluetooth

a. Ensure that the phone is connected to WIFI and Bluetooth is turned on.

b. Bluetooth will automatically scan attachment devices for result display.

c. Select the device to be connected and click on the device name.

Method 2: Add by scanning. This method supports devices with QR codes. If you do not have a QR code, please choose another method

a. Click on 'Scan'.

b. Align the device QR code with the mobile phone scan focus, and the results will be displayed in a list.

c. Select the device to be connected based on the result list, and click on the device name.

Method 3: Add by entering SN [If only one device is connected at a time, this method is recommended]

a. Click on 'Enter SN'.

b. Enter the device SN code.

c. After entering the device SN code, click "Next".

After adding, enter the distribution network, Enter WiFi account and password, Click "Start Provisioning".

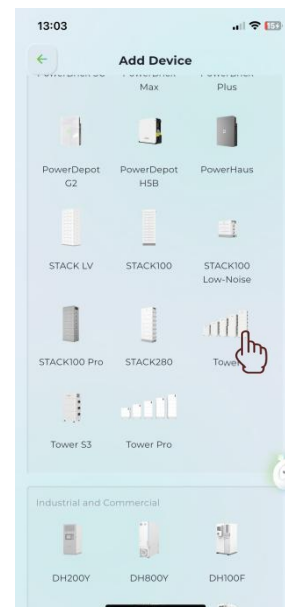
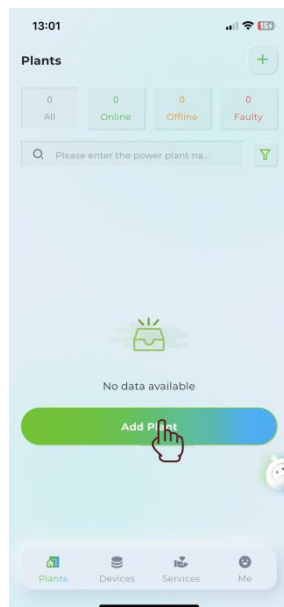

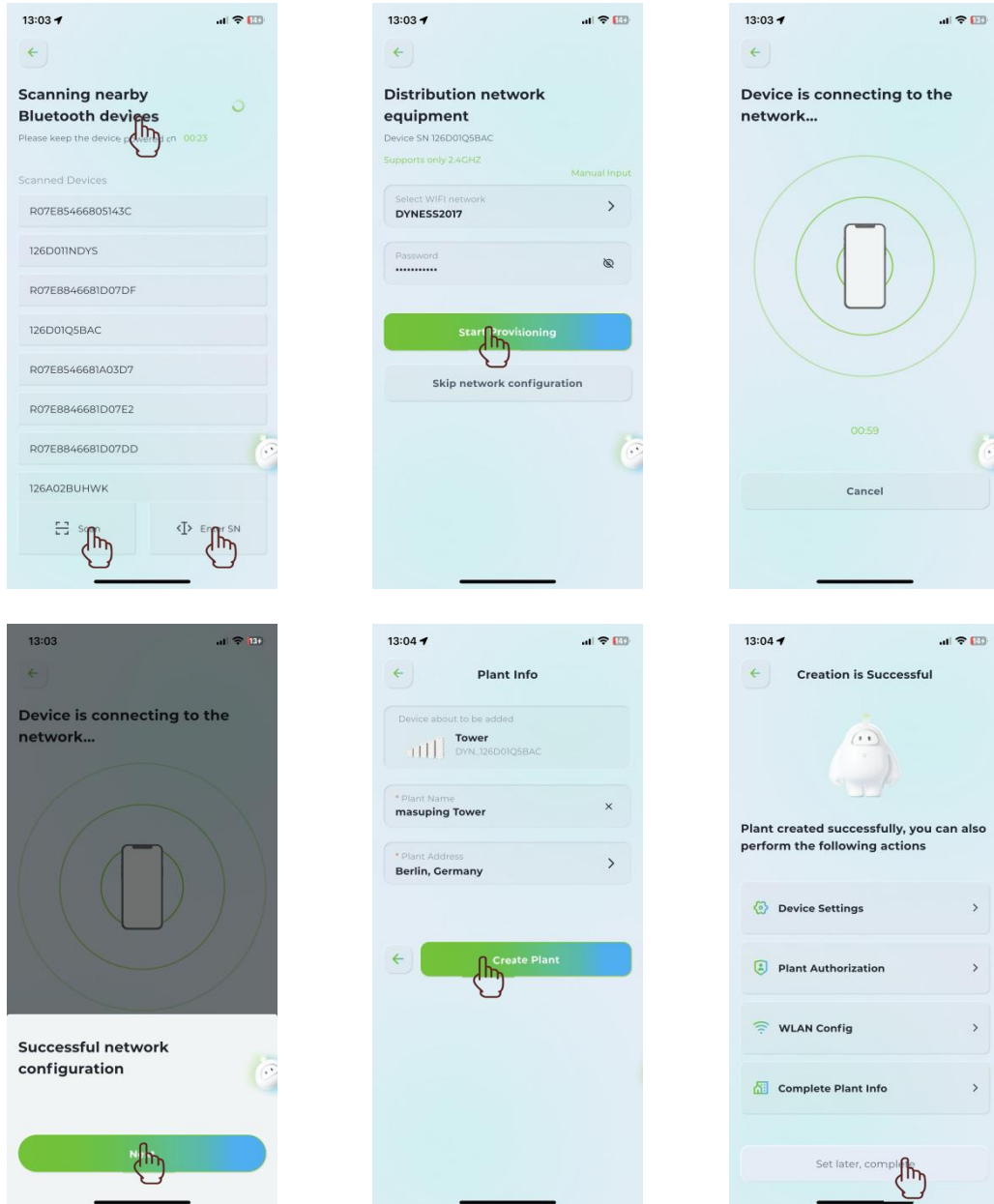

- View battery information

After successful network configuration, wait for 5~10 minutes, Click "Plants". The default display of device real-time data is detailed, BMS information and historical data and basic information can be viewed by switching tabs

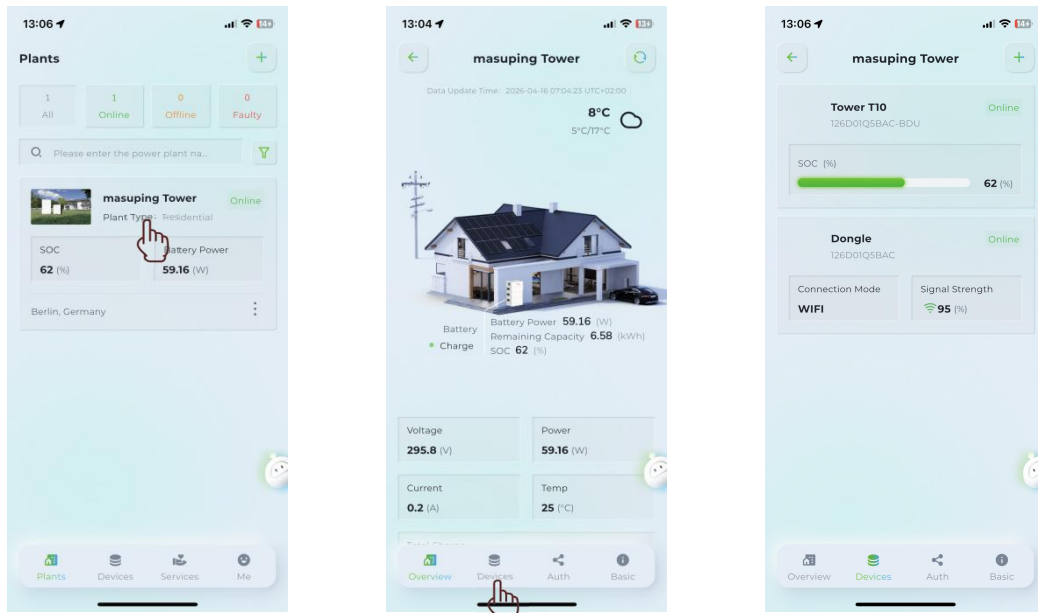

By switching tabs to enter the real-time data information page, you can view the data information of energy storage devices.

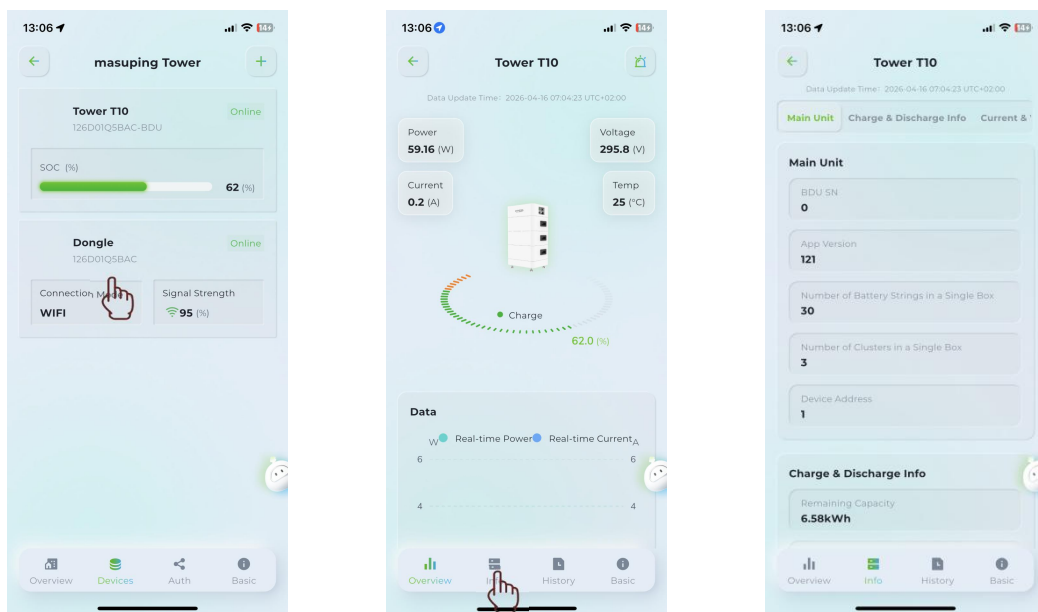

By switching tabs to enter the historical data page, you can view the historical data of energy storage devices.

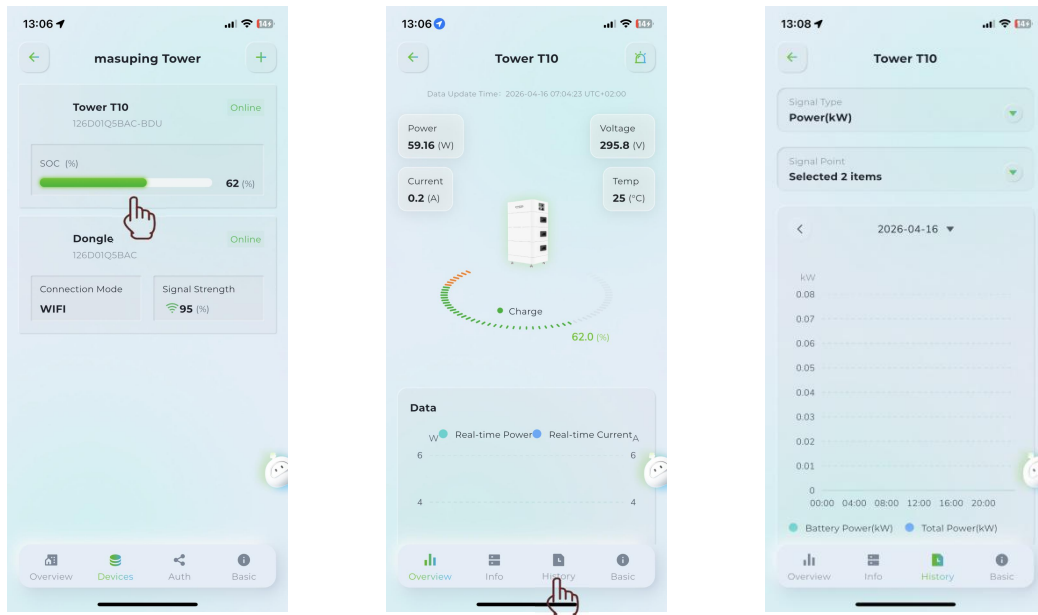

By switching tabs to enter the basic information page, you can view the basic information of the energy storage device.

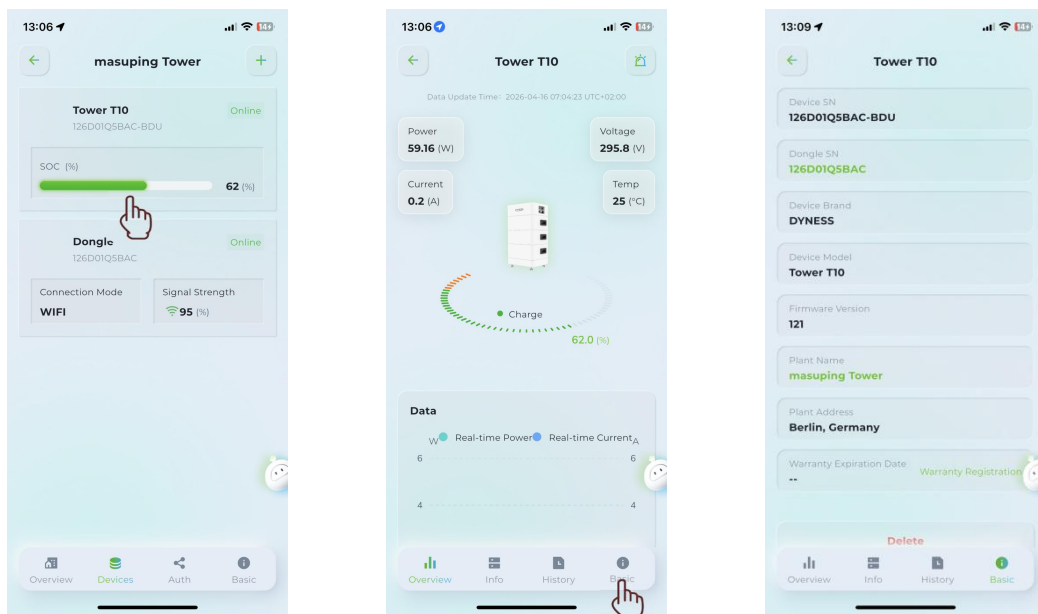

WiFi status indicators:

- If the yellow light **flashing**, it indicates that the distribution network has failed or not been distributed.
- If the yellow light remains on, it indicates successful network distribution and communication is currently being connected.
- If the green light remains on, it indicates successful network distribution and normal communication between BMS and WiFi.

4 Maintenance

Troubleshooting:



DANGER

The battery system is a high-voltage DC system. Ensure that the installation area of the STACK100 is stable and reliable.

Please confirm that the battery system is switched off before connecting.

Electric shock and damage to the inverter may be caused if the battery is connected to the inverter directly without being powered off.

Otherwise, the system cannot operate properly. The voltage of the battery is too high, please pay attention to self-protection during measurement.

No.	Problem	Possible Reason	Solution
1	Pressing the "WAKE" button does not turn on the device, and the "D" light remains off.	The BDU DC breaker is not switched on.	Switch the BDU DC breaker on.
		The ON/OFF switch of the BDU is not switched on.	Switch the ON/OFF switch on.
		The battery voltage is severely low (<100V) or damaged.	Contact the battery manufacturer for further inspection.
2	Pressing the "WAKE" button turn on the device, the "D" light will turn on, but the display status of the light is yellow or red.	Improper placement of batteries and BDU during installation, resulting in misalignment of blind insertion pins.	Check the blind insertion pin and reset the misplaced blind insertion pin.
		Battery system protection.	Charge the battery to leave protection mode, or contact the battery manufacturer for further inspection.

3	The battery has no voltage output.	Battery changes into over-discharged protection.	Charge the battery to leave protection mode.
		Communication failure with inverter.	Check if the connection of the communication cable and PIN definition are correct.
		Inverter has an error.	Check for inverter errors and restore the inverter.
4	Battery shutdown.	BDU DC circuit breaker open circuit.	Switch the BDU DC breaker on.
		Battery changes into over-discharged protection.	Charge the battery to leave protection mode.
		Battery is in sleep mode.	Press and hold the WAKE button for approx. 15s.
5	SOC jump during battery charging and discharging process.	The battery system has not undergone full charge calibration for a long time.	Perform a full charge calibration once.
		Inconsistent SOC of battery module.	The system performs 10 ~ 50 full charge balancing cycles (depending on the SOC difference of the module, the number of full charge balancing will vary); or fully charge each battery module separately with BDU and DC power supply.
		Differences in battery cell consistency or damage.	Contact the battery manufacturer for further inspection.

Replacement of Main Components

Replacing the Battery Controller (BDU)

WARNING

Turn off the entire battery system. Ensure that the negative and positive terminals are de-energized.

1. Turn the POWER ON knob to OFF, battery shutdown

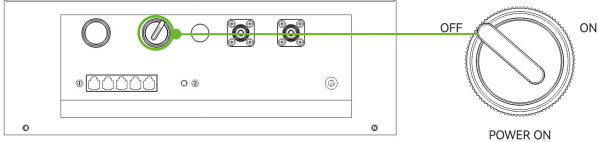

2. Switch the BDU DC BREAKER to OFF position.

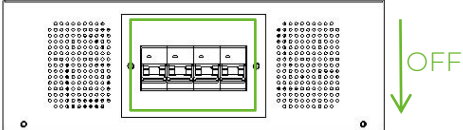

- Disconnect the connecting cable.
- Remove the four screws on the BDU and remove the BDU from the system.



Figure 4-1 BDU right connector

- Exchange BDU. Then fix it with two screws.
- After replacing the new BDU, the battery self-test needs to be performed again (Refer to P19 Table 3-2 Battery system self-test)

Battery Maintenance



DANGER

Battery maintenance should only be carried out by professional and authorized persons.

Turn off the battery system first carrying out maintenance.

Voltage check:

[Periodical maintenance] Check the voltage of the battery system with the monitoring software. Check whether the system voltage is normal. For example: Check whether the single cell voltage is out of range.

Voltage check:

[Periodical maintenance] Check the SOC of the battery system with the monitoring software. Check whether the SOC of the batteries is normal.

Cable check:

[Periodical maintenance] Visually inspect all cables of the battery system. Check whether the cables are broken, aging or loose.

Balancing:

[Periodical maintenance] The battery system will become unbalanced if it has not been charged fully for a long time. Solution: Perform balancing maintenance (fully charge) every 10~12 month. Generally this maintenance progress needs to be completed when external devices such as the monitoring software and battery and inverter have proper communication.

Output relay check:

[Periodical maintenance] Under low load (low current), check the output relay OFF and ON condition; listen if the relay clicks, which means that it switches off and on normally.

5 Storage

For long-term storage (more than 3 months), the battery cells should be stored within the temperature range of 5 to 45°C, relative humidity <65% and non-corrosive gases.

The battery module should be stored within the temperature range of 5 to 45°C, dry, clean and well ventilated environment. The battery should be charged to 50 - 55% SOC before storage.

We recommend activating the battery system (discharge and charge) every 10~12 months.

Corresponding to the battery system that has been installed and used normally, it is necessary to regularly fully charge the battery to calibrate the SOC. It is recommended to fully charge and calibrate at least once every 2 weeks.



CAUTION

The lifespan of the battery will be greatly reduced if you do not follow above instructions to store the battery for a long term.

6 Shipment

The battery module is pre-charged to 50% SOC or according to customer requirements before shipment. The remaining capacity of battery cells is determined by the storage time and condition after shipment.

The battery modules meet UN38.3 certificate standard.

In particular, special rules for the carriage of goods on the road and the current dangerous goods law, specifically ADR (European Convention on the International Carriage of Dangerous Goods by Road), as amended, must be observed.

Annex 1 Stack100 Expansion Pack Usage Guide

The difference between the base and how to use it



Standard Base



Expansion Base



CAUTION

When using a Single column, the base needs to use a standard base, and the expansion base cannot be used. When using the expansion, the standard base needs to be converted into an expansion base. When using the expansion, the standard base cannot be used in any cluster.

Expansion Pack Parts

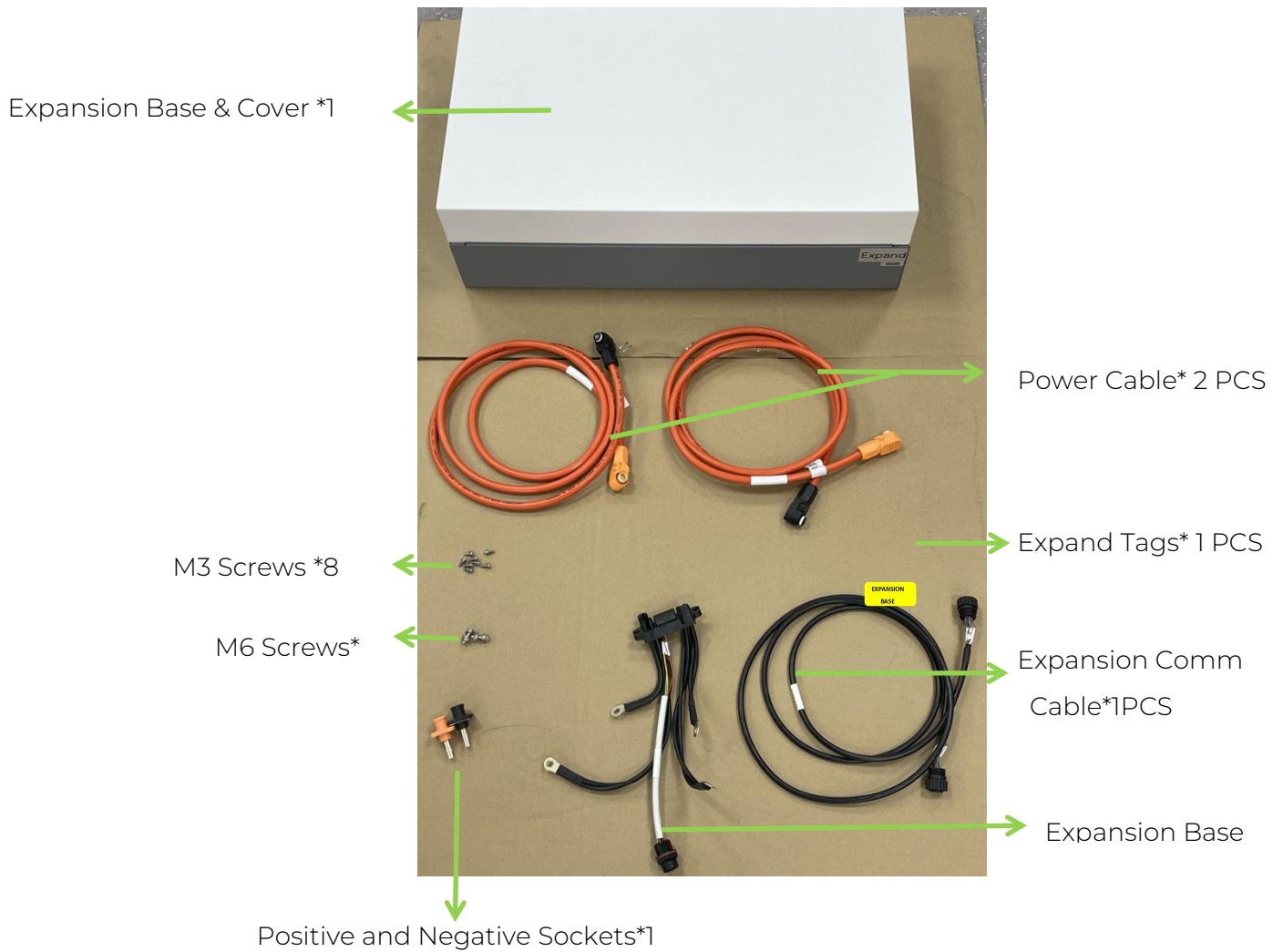

The original system standard base needs to be modified to an expansion base



1. Remove the original base panel

Remove the four bolts that are fixed by the panel and remove the panel.

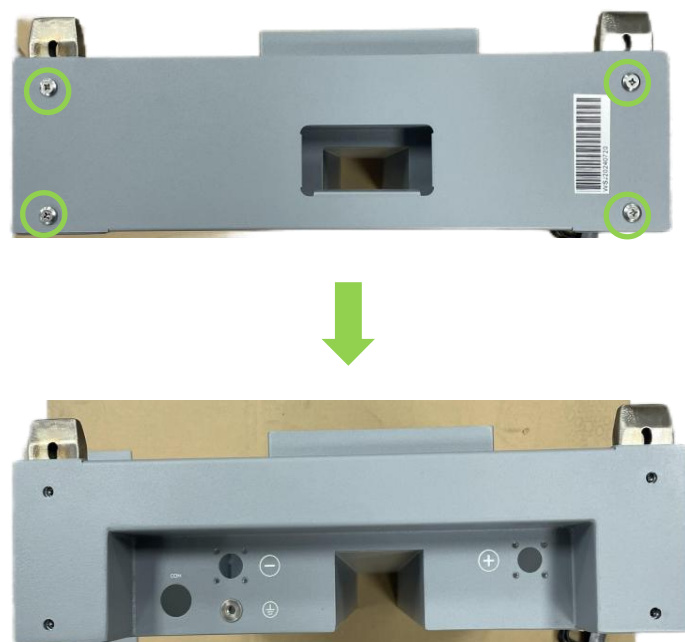

2. Disassemble the plug-in from the original base

Remove the 2 fixing bolts.



3. Install the positive and negative terminal plugs

Install the positive and negative sockets and lock them with 8 M3 screws.



CAUTION

The positive and negative sockets need to be installed according to the silk screen mark on the base, and cannot be installed in reverse.

4. Install the extension plugin and secure the plugin cable bundle

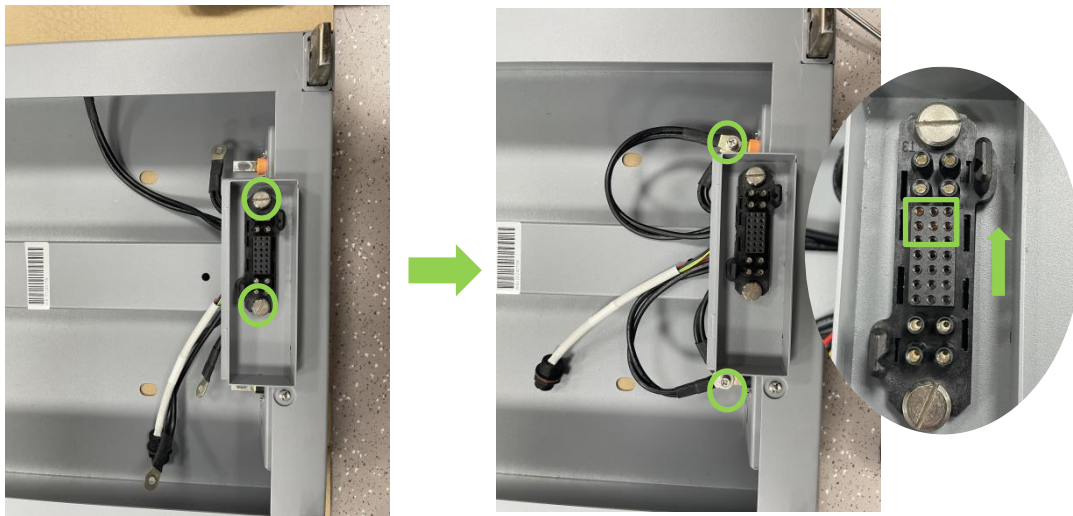

 CAUTION

1. Both positive and negative terminals need to have two wires fixed to them.
2. When installing the plug-in, the terminals inside the plug-in need to be upward.

5. Install the communication interface



6. After the base modification is completed, a label needs to be attached



System Expand stacking



Connect the series cable

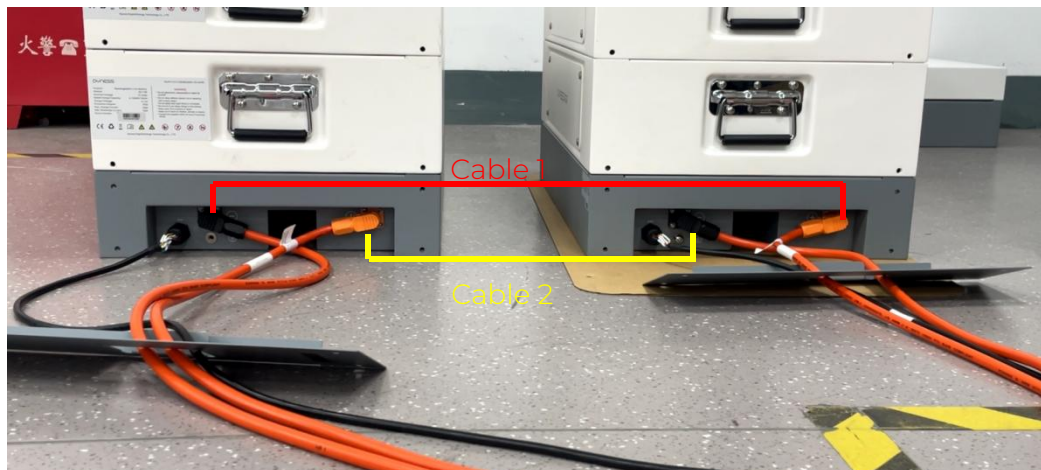

CAUTION

The cables need to be connected as shown above, the black plug needs to be connected to the black socket, and the Orange plug needs to be connected to the Orange socket.

EU Declaration of Conformity

within the scope of the EU directives

- Radio Equipment Directive 2014/53/EU (22.5.2014 L 153/62) (RED)
- Restriction of the use of certain hazardous substances 2011/65/EU (L174/88, June 8, 2011) and 2015/863/EU (L 137/10, March 31, 2015) (ROHS)

Dyness Digital Energy Technology Co., LTD confirms herewith that the products described in this document are in compliance with the fundamental requirements and other relevant provisions of the aforementioned directives. More information on the availability of the entire declaration of conformity can be found at <https://dyness.com/declarations-of-conformity>.

Ratings	25.6-1000VDC, 30-300A
Frequency Range	2400MHz-2483.5MHz
Network Interface	802.11b/g/n, BLE 5.

DYNNESS

Address: No.688, Liupu Road, Guoxiang Street, Wuzhong Economic Development Zone,
Suzhou, Jiangsu, China
Email: service@dyness-tech.com
Tel: +86 400 666 0655
Web: www.dyness.com



Official Website



Digital version access