



TURBO HD 2 MP Cube Camera

User Manual

User Manual

Thank you for purchasing our product. If there are any questions, or requests, do not hesitate to contact the dealer.

This manual applies to the models below:

Model
DS-2CE38D8T-PIR

This manual may contain technical incorrect places or printing errors, and the content is subject to change without notice. The updates will be added to the new version of this manual. We will readily improve or update the products or procedures described in the manual.

Regulatory Information

FCC Information

Please take attention that changes or modification not expressly approved by the party responsible for compliance could void the user's authority to operate the equipment.

FCC compliance: This equipment has been tested and found to comply with the limits for a Class A digital device, pursuant to part 15 of the FCC Rules. These limits are designed to provide reasonable protection against harmful interference when the equipment is operated in a commercial environment. This equipment generates, uses, and can radiate radio frequency energy and, if not installed and used in accordance with the instruction manual, may cause harmful interference to radio communications. Operation of this equipment in a residential area is likely to cause harmful interference in which case the user will be required to correct the interference at his own expense.

FCC Conditions

This device complies with part 15 of the FCC Rules. Operation is subject to the following two conditions:

1. This device may not cause harmful interference.
2. This device must accept any interference received, including interference that may cause undesired operation.

EU Conformity Statement



This product and - if applicable - the supplied accessories too are marked with "CE" and comply therefore with the applicable harmonized European standards listed under the Low Voltage Directive 2014/35/EU, the EMC Directive 2014/30/EU.

2012/19/EU (WEEE directive): Products marked with this symbol cannot be disposed of as unsorted municipal waste in the European Union. For proper recycling, return this product to your local supplier upon the purchase of equivalent new equipment, or dispose of it at designated collection points. For more information see: www.recyclethis.info.



2006/66/EC (battery directive): This product contains a battery that cannot be disposed of as unsorted municipal waste in the European Union. See the product documentation for specific battery information. The battery is marked with this symbol, which may include lettering to indicate cadmium (Cd), lead (Pb), or mercury (Hg). For proper recycling, return the battery to your supplier or to a designated collection point. For more information see: www.recyclethis.info.



Industry Canada ICES-003 Compliance

This device meets the CAN ICES-3 (A)/NMB-3(A) standards requirements.

Warning

This is a class A product. In a domestic environment this product may cause radio interference in which case the user may be required to take adequate measures.



Safety Instruction

These instructions are intended to ensure that user can use the product correctly to avoid danger or property loss.

The precaution measure is divided into “Warnings” and “Cautions”.

Warnings: Serious injury or death may occur if any of the warnings are neglected.

Cautions: Injury or equipment damage may occur if any of the cautions are neglected.

	
Warnings Follow these safeguards to prevent serious injury or death.	Cautions Follow these precautions to prevent potential injury or material damage.



Warnings

- In the use of the device, you must be in strict compliance with the electrical safety regulations of the nation and region.
- Input voltage should meet both the SELV (Safety Extra Low Voltage) and the Limited Power Source with 12 VDC according to the IEC60950-1 standard. Refer to technical specifications for detailed information.
- Do not connect multiple devices to one power adapter to avoid over-heating or a fire hazard caused by overload.
- Make sure that the plug is firmly connected to the power socket.
- Make sure that the device is firmly fixed if wall mounting or ceiling mounting is adopted.
- If smoke, odor or noise rise from the device, turn off the power at once and unplug the power cord, and then contact the service center.
- Never attempt to disassemble the camera by unprofessional personal.



Cautions

- Do not drop the camera or subject it to physical shock.
- Do not place the camera in extremely hot, cold (the operating temperature shall be -40°C to 60°C), dusty or damp locations, and do not expose it to high electromagnetic radiation.
- Do not touch sensor modules with fingers.
- If cleaning is necessary, use clean cloth with a bit of ethanol and wipe it gently.
- Do not aim the camera at the sun or extra bright places.
- The sensor may be burned out by a laser beam, so when any laser equipment is in using, make sure that the surface of sensor will not be exposed to the laser beam.
- Do not expose the device to high electromagnetic radiation or extremely hot, cold, dusty or damp environment.
- To avoid heat accumulation, good ventilation is required for the operating environment.

- Keep the camera away from liquid while in use for non-water-proof device.
- While in delivery, the camera shall be packed in its original packing, or packing of the same texture.

Mark Description

Table 0-1 Mark Description

Mark	Description
---	DC Voltage

1 Introduction

1.1 Product Features

The camera is applicable for indoor conditions, and the application scenarios include office, store, living room, etc..

The main features are as follows:

- High performance CMOS sensor
- Low illumination, 0.005 Lux @ (F1.2, AGC ON), 0 Lux with IR
- IR cut filter with auto switch
- 120 dB true WDR
- PIR detection
- OSD menu with configurable parameters
- Auto white balance
- Internal synchronization
- SMART IR mode

1.2 Overview

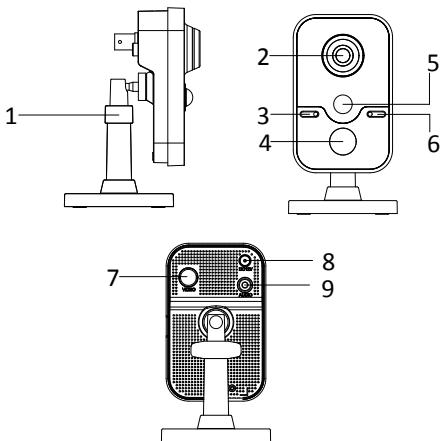

Figure 1. 1 Overview of Camera

Table 1-1 Camera Description

No.	Description
1	3-axis Bracket
2	Lens
3	Built-in Microphone
4	IR LED
5	PIR
6	Photosensitive IC Chip
7	Video Interface
8	12 VDC Power Supply
9	Audio Interface

2 Installation

2.1 Installation Preparation

Before you start:

- Make sure that the device in the package is in good condition and all the assembly parts are included.
- Make sure that all the related equipment is power-off during the installation.
- Check the specification of the products for the installation environment.
- Check whether the power supply is matched with your required output to avoid damage.
- Make sure the wall is strong enough to withstand three times the weight of the camera and the bracket.
- If the wall is cement, insert expansion bolts before installing the camera. If the wall is wooden, use self-tapping screw to secure the camera.
- If the product does not function properly, contact your dealer or the nearest service center. Do NOT disassemble the camera for repair or maintenance by yourself.

2.2 Standing Mounting

Steps:

1. Take the bracket out of the package.

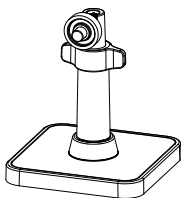

Figure 2-1 Bracket

2. Align the camera body to the bracket, and rotate the camera body to fix it with the bracket.

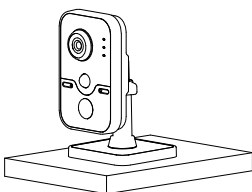

Figure 2-2 Install the Camera Body

3. Put the camera on the flat surface.

2.3 Ceiling Mounting

1. Paste the drill template to the ceiling.
2. Drill the screw holes according to the drill template.



Figure 2-3 Drill Template

3. Disassemble the 3-axis bracket.
 - (1) Hold the base with one hand.
 - (2) Rotate the pole anticlockwise to disassemble the pole from the base.

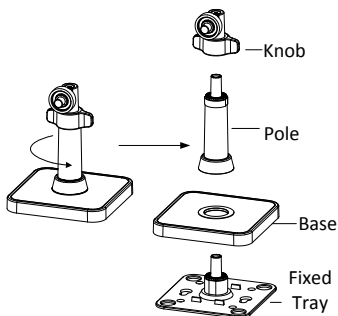

Figure 2-4 Disassemble the Bracket

4. Install the fixed tray to the ceiling with supplied screws.
5. Install the base to the fixed tray.

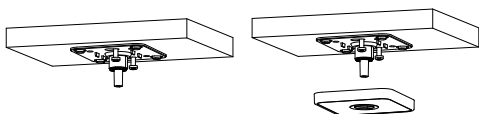

Figure 1-1 Install the Mounting Base to the Fixed Tray

6. Install the camera to the bracket.

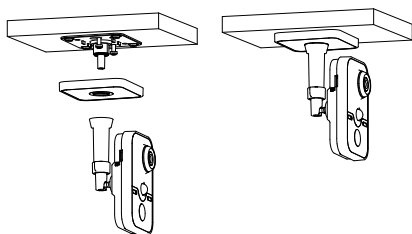

Figure 2-5 Install the Camera

7. Connect the corresponding power cord, and video cable.
8. Power on the camera to check whether the image on the monitor is gotten from the optimum angle. If not adjust the surveillance angle.
 - (1) Loosen the knob to adjust the panning position and tilting position.
 - (2) After adjusting the angle of the camera to the desired position, fasten the knob.

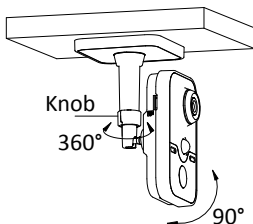



Figure 2-6 Adjust the Camera

3 Menu Description

Purpose:

Call the menu by clicking icon  on the PTZ Control interface, or call preset No.95.

Steps:

1. Connect the camera with the TVI DVR, and the monitor, shown as the figure 3-1.



Figure 3-1 Connection

2. Power on the analog camera, TVI DVR, and the monitor to view the image on the monitor.
3. Click PTZ Control to enter the PTZ Control interface.
4. Call the camera menu by clicking  icon, or call preset No. 95.

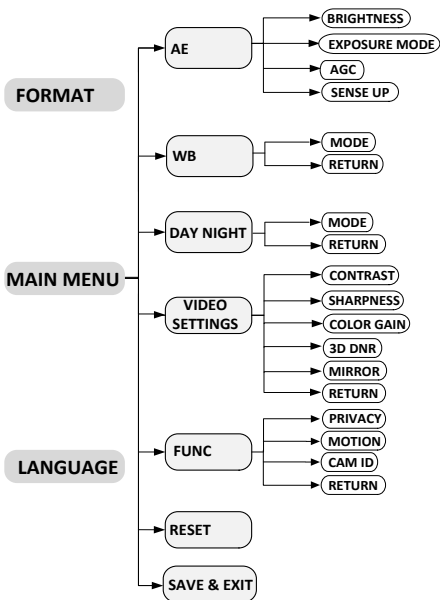

Figure 3-2 Main Menu Overview

5. Click the direction arrow to control the camera.
 - (1) Click up/down direction button to select the item.
 - (2) Click Iris + to confirm the selection.
 - (3) Click left/right direction button to adjust the value of the selected item.

3.1 FORMAT

PAL (Phase Alternating Lines)

PAL is a color encoding system for analog television used in broadcast television systems in most countries.

NTSC: (National Television System Committee)

NTSC is the analog television system that is used in most of North America, parts of South America, Myanmar, South Korea, etc.

3.2 LANGUAGE

Supports English, and Chinese.

3.3 MAIN MENU

3.3.1 AE (AUTO EXPOSURE)

Auto Exposure describes the brightness-related parameters, which can be adjusted by **BRIGHTNESS**, **EXPOSURE MODE**, **AGC**, and **SENSE UP**.

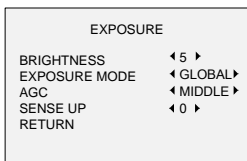

Figure 3-3 AE

BRIGHTNESS

Brightness refers to the brightness of the image. You can set the brightness value from 1 to 10 to darken or brighten the image. The higher the value, the brighter the image is.

EXPOSURE MODE

You can set the **EXPOSURE MODE** as **GLOBAL**, **BLC**, and **WDR**.

- **GLOBAL**

GLOBAL refers to the normal exposure mode which adjusts lighting distribution, variations, and non-standard processing.

- **BLC (Backlight Compensation)**

BLC (Backlight Compensation) compensates light to the object in the front to make it clear, but this may cause the over-exposure of the background where the light is strong.

When BLC is selected as the exposure mode, the BLC level can be adjusted from 0 to 8.

- **WDR (Wide Dynamic Range)**

The wide dynamic range helps the camera provide clear images even under backlight circumstances. WDR balances the brightness level of the whole image and provides clear images with details.

AGC (Auto Gain Control)

It optimizes the clarity of the image in poor light conditions. The **GAIN** level can be set as **HIGH**, **MIDDLE**, or **LOW**. Select **OFF** to disable the **GAIN** function.

Note:

The noise will be amplified when the GAIN is on.

SENSE UP

Sense up increases the exposure on a signal frame, which makes a camera more sensitive to light so it can produce images even in low lux conditions. You can set the SENS-UP as OFF or AUTO according to different light conditions.

The SENS-UP function will atomically adjust itself to x2, x4, x6, x8, x10, x12, x14, and x16 according to the different light conditions.

3.3.2 WB (White Balance)

White balance, the white rendition function of the camera, is to adjust the color temperature according to the environment. It can remove unrealistic color casts in the image. You can set WB mode as **ATW**, or **MWB**.

ATW (Auto Tracking White Balance)

Under **ATW** mode, white balance is being adjusted automatically according to the color temperature of the scene illumination.

MWB (Manual White Balance)

You can set the **R GAIN/B GAIN** value from 1 to 255 to adjust the shades of red/blue color of the image.

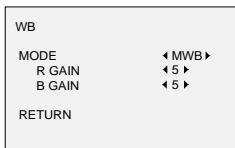

Figure 3-4 MWB MODE

3.3.3 DAY NIGHT

Color, **BW** (Black White), and **AUTO** are selectable for DAY and NIGHT switches.

COLOR

The image is colored in day mode all the time.

B/W

The image is black and white all the time, and the IR LED turns on in the low-light conditions.

AUTO

You can turn on/off the **INFRARED** and set the value of **SMART IR** in this menu.

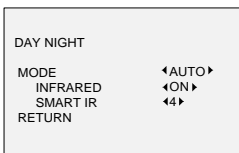

Figure 3-5 DAY NIGHT

● INFRARED

You can turn on/off the IR LED to meet the requirements of different circumstances.

● SMART IR

The **Smart IR** function is used to adjust the light to its most suitable intensity, and prevent the image from over exposure. The **SMART IR** value can be adjusted from 1 to 8. The higher the value the more obvious effects are.

3.3.4 VIDEO SETTING

Move the cursor to **VIDEO SETTING** and click Iris+ to enter the submenu. **CONTRAST**, **SHARPNESS**, **COLOR GAIN**, **3D DNR**, and **MIRROR** are adjustable.

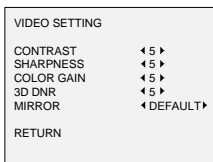

Figure 3-6 VIDEO SETTING

CONTRAST

This feature enhances the difference in color and light between parts of an image. You can set the **CONTRAST** value from 1 to 10.

SHARPNESS

Sharpness determines the amount of detail an imaging system can reproduce. You can set the **SHARPNESS** value from 1 to 10.

COLOR GAIN

Adjust this feature to change the saturation of the color. The value ranges from 1 to 10.

3D DNR (Digital Noise Reduction)

The 3D DNR function can decrease the noise effect, especially when capturing moving images in low light conditions and delivering more accurate and sharp image quality. You can set the **DNR** value from 1 to 10.

MIRROR

DEFAULT, **H**, **V**, and **HV** are selectable for mirror.

DEFAULT: The mirror function is disabled.

H: The image flips 180° horizontally.

V: The image flips 180° vertically.

HV: The image flips 180° both horizontally and vertically.

3.3.5 FUNC (Functions)

In the FUNC sub-menu, you can set the privacy mask, the motion detection, and camera ID of the camera.

PRIVACY

The privacy mask allows you to cover certain areas which you don't want to be viewed or recorded. Up to 4 privacy areas are configurable.

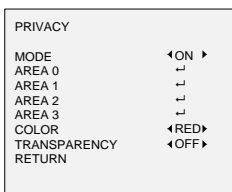

Figure 3-7 PRIVACY

Select a PRIVACY area. Set the DISPLAY status as ON. Click up/down/left/down button to define the position and size of the area.

MOTION

In the user-defined motion detection surveillance area, the moving object can be detected and the alarm will be triggered. Up to 4 motion detection areas can be configured.

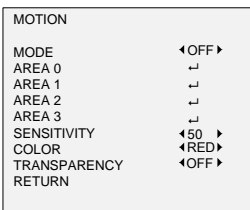

Figure 3-8 MOTION

Select a MOTION area. Set the DISPLAY status as ON. Click the up/down/left/right button to define the position and size of the area. Set the SENSITIVITY from 0 to 100.

CAMERA ID

Edit the camera ID on this section.

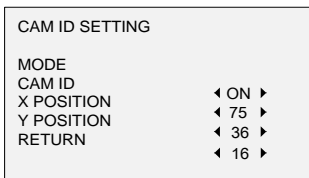

Figure 3-9 CAM ID SETTING

Set the MODE as on. Click up/down left/right button to choose the camera ID and the position.

3.3.6 RESET

Reset all the settings to the default.

3.3.7 SAVE & EXIT

Move the cursor to **SAVE & EXIT** and click Iris+ to save the setting and exit the menu.