



## Warranty

To receive after-sales service, have the following ready when you contact our branches

1. Name of the product
2. Model number of the product
3. The area of problem
4. Phone number and address at which you can be contacted.

## Warranty Card

PRODUCT	
MODEL	
DATE PURCHASED	
WARRANTY PERIOD	
AGENCY ADDRESS	

☉ **KOCOM Warranties the original purchaser of this product as follows.**

- 1) This product is produced under strict quality control and inspection procedures.
- 2) If this product breaks down during proper use as a result of product defect, KOCOM will repair it within one year from date of purchase free of charge.
- 3) The following cases will be subject to charge, even during warranty period:
  - a. Breakdown during transport, or through careless treatment, by consumer.
  - b. Breakdown caused by unauthorized repair, or system modification.
  - c. Breakdown caused by natural disaster or power disorder.

# KCV-W354 / DW354 MANUAL

[ 4 Wire Color Handsfree Videophone ]



KCV-W354 / DW354

- 3.5inch Digital LCD (NTSC / PAL)
- LCD OSD Menu
- Room to Door Communication and Monitoring
- 5 Melody Selection
- Ultra Low Power Consumption
- Communication between Main Monitor and Sub Units
- Surface Mount Installation
- Door Opener Connectable from Either Monitor or Camera
- Connection up to 2 Door Cameras and 2 Monitors with Sub-Audio Unit (KDP-602G)



□ KC-C60

□ KC-MC24

□ KC-MC20

□ KC-MC30

□ KC-MC31

# Cautions for Safety

For safe use, please stick to the following cautions.

- Please, save this manual after reading these instructions carefully.
- Read and understand all instructions to set up rightly.
- This Cautions for Safety may include items that are not contained in specifications of the product that consumer purchases.
- If you need assistance with the set-up or operation, please contact with A/S center.

## The important marks in the manual.

To help our customers to understand this manual, to prevent any personal injury or property damage, some marks are used in the manual. The marks and the drawing signs are below. Please, understand the marks before reading the manual.

## The meaning of the drawing signs.

<td>Sign to show what not to do</td> <td> <td>Mishandling the device with ignoring this sign may result in serious injury or death.</td> </td>	Sign to show what not to do	<td>Mishandling the device with ignoring this sign may result in serious injury or death.</td>	Mishandling the device with ignoring this sign may result in serious injury or death.
<td>Mishandling the device with ignoring this sign may result physical injury or material damage.</td> <td></td> <td></td>	Mishandling the device with ignoring this sign may result physical injury or material damage.		
<td>Sign to tell you that you should follow the instructions.</td> <td> <td>Sign to tell you that you need more attention including high voltages, electric shock, danger, warning)</td> </td>	Sign to tell you that you should follow the instructions.	<td>Sign to tell you that you need more attention including high voltages, electric shock, danger, warning)</td>	Sign to tell you that you need more attention including high voltages, electric shock, danger, warning)
<td>Sign to tell you that you can't disassemble this unit.</td> <td> <td>Sign to tell you that you must unplug the unit.</td> </td>	Sign to tell you that you can't disassemble this unit.	<td>Sign to tell you that you must unplug the unit.</td>	Sign to tell you that you must unplug the unit.

## 

### • Cautions for Set-up

- The law limits distributing the power lines to an authorized person from government. The work from an unauthorized person cause fire or electric shock.
- Place this unit securely on a stable surface. Serious damage and/or injury may result if the unit falls.
- Do not set up this unit near the leaking place because it may expose you to dangerous voltages or other risks.
- Even if your product is water proof, do not install it slanted place of water leakage, which can a short circuit.
- The work of distributing wires needs skills and experiences. So please, for assistance, contact your dealer or call service center.
- The communication lines should be built in being distant from the power source. This may result in the risk of fire, electric shock and communication disorder.
- Setting the communication lines in a high humid place such as outside without any protection from rain causes the communication disorder.
- Keep the hook at the wall-mounted device safe. The hook may cause the physical injury.
- Think about the thickness and quality of wall material. The unqualified material may make the device fall.
- Set the device of the wall-mounted type not to fall. Falling from an earthquake causes personal injury.

### • Cautions for Use

- Do not overload on the device.

### • Cautions for Repairs and Maintenance

- Keep the inside of the device clean. Having the dust inside without any cleaning for a long time causes the fire. If necessary, contact your dealer or service center to get cleaning service.
- Unplug this device when you want to check the inside. If there is no plug, please, turn off the circuit breaker.
- Unplug this device when you try to move it to another place. If the electric line is connected inside of the unit, please contact your dealer or service center
- Do not use liquid or aerosol cleaners. Use a damp cloth for cleaning

## 

### • Warnings for Usage

- Do not install this unit near the water and dust, for example, in a bathroom or near the washing machine. It caused fire and electric shock.
- Do not install this unit near the fire, for example, near kitchen sink, heater or the like.
- Do not install near the noxious gas such as Hydrogen Sulfide, metal power and the like.
- Do not install near the water and chemicals.
- Do not give any damage, break and modify the plug. Overloading, heating, pulling causes the damage.
- Do not place the plug near the heater. The damaged code causes fire and electric shock. Do not pull the power code when unplugging.
- The damaged code causes fire and electric shock. Must pull with plug. Do not touch with wet hands. It causes the electric shock.
- Do not use any other voltage, except the marked regular voltage.
- Do not use the power terminal at the units to other electric device except the designed device.
- Do not install the units at the leaking place if it doesn't have any waterproof mark. Do not install the unit when the power is on.
- Install the circuit breaker after checking the safety such as electric shock and leakage. Turn off the power before you install or A/S
- Check the suitability of the lines for installing when you use the exiting lines.
- Do the wiring work by using the designed material.
- Connect the electric wire with the designed ways and ground.
- Do not connect with any other devices except the designed devices to compose the system.
- Unplug electric wire and communication lines from the units before moving to another place.

### • Cautions for Use

- This unit is not designed for security purpose.
- Do not handle the unit with the wet hands.
- Do not place a pot with water or a small metal material on the Units.
- Do not cover the ventilating opening or put any metal material in the units.
- Open the main gate after checking ID if the image and sound system do not work. Call A/S
- During thunderstorms, avoid using this unit.
- There may be a remote risk of an electric shock from lightning.
- Do not modify the unit.
- Do not disassemble the back and cabinet cover.

### • Cautions for Abnormality

- Change the damaged electric code.
- Unplug this unit from plug socket and refer servicing to an authorized service center when the following conditions occur:
- If liquid has been spilled into the unit.
- If the unit does not work normally by following the operating instructions.
- If the unit exhibits a distinct change in performance.
- If the unit has been dropped or physically damaged.

## Caution

### • Safety Instructions, Warnings and Cautions of Each System

- Do not disassemble this unit at will as this device is composed by precision parts.
- Install the unit by following the set-up instructions of Kocom.
- Do not touch or insert any foreign substances, for example, sticker, magnetic, opener and the like
- Make U-type at the end of wires as the rain can effect on the system by following the wires during the rainy season.

### • Videophone

- Separate the AC/DC lines with the hook of the wall-mounted type when installing.
- Connect the lines after peeling the wires properly
- Do not distribute signal line with AC line.
- Use the designed driver to connect the lines to terminal
- Do not clean the LCD with the damp cloth for cleaning. Use the only dry and soft cloth.
- Do not install the main gate monitor at the leaking place.

### • Things You Need to Know

- This product is designed as a home videophone and cannot use continuously like monitor camera.
- If there is temperature difference between inner part of camera and surrounding, dew condensation occurs on camera lens and may disturb image. If dew condensation is removed from camera lens, image quality recovers.
- White LED light examination range is narrower than camera shot range at night, so there is less amount of light at night than day. So it is difficult to see the face in low illumination condition due to noise increase on screen, but it is not from defect.
- Monitor screen (liquid crystal panel) is not in detect when some pixels always light or black out.
- Please install monitor and camera over 5cm away. Also, avoid installing at a place with too much noise, because too much noise around camera causes phone call inferiority.
- Do not place an object within 20cm in front of monitor. It causes phone call inferiority, especially because microphone is installed at the top of monitor.
- If strong light such as sunlight flows into camera module, screen saturation (or strange mark) and image shaking might occur. This is not a defect, so please do not install camera where a direct ray of light do not flow if possible.

### • Cautions

- In some cases there is occurrence of product destruction, malfunction, noise mixing and picture quality deterioration due to mixing of other tools induced voltage or thunder with communication wiring of monitor/camera, monitor/extended monitor.
- Do not wire with power line such as outdoor wiring or AC power, or phones and other tools.
- You cannot use it if you incorrectly wire the AC voltage between monitor/camera, monitor/extended monitor. Call the store or agency where you purchased this product and consult to solve the problem.
- Beware that unfixable damage might be caused due to authorizing AC voltage on communication wiring of monitor/camera, monitor/extended monitor.
- Do not ever disjoint this product. It may cause electrocution accident when touching high-voltage circuit inside this product.
- Outside power authorizing this product must be confirmed of product description and use rated voltage. Beware that if higher voltage is authorized, unfixable damage might be caused due to product destruction.
- Power must be connected to domestic voltage (product rated voltage) consent or interior wiring.
- If connected to other motive power or inverter-type power, product destruction, noise mixing, and picture distortion may occur.
- Do not drop this product. Glass is used for monitor and might break, or cause other circuit inferiority.
- In such case, immediately turn down the power switch, and call to consult agency or store in which this product was purchased.
- If installed near transmission antenna such as broadcasting station, electric wave may mix and cause picture distortion or voice mixing.
- Avoid installing near tools with strong electromagnetic waves such as microwaves and cell phones, or it may cause picture distortion.
- Do not install monitor in following places.
  - ① Above or around water heater, rice-cooker, heater
  - ② Place exposed to direct rays of the sun
  - ③ Place with temperature below 0°C such as cold store
  - ④ Place with high humidity such as bathroom, washroom, heated room
  - ⑤ Place with a lot of gas, dust, smoke
  - ⑥ Dangerous place with sprays of water or chemicals
- Do not wipe with insecticide, drugs or chemicals such as thinner and alcohol, or it may damage the surface of this product.
- Beware of occurrence of image quality deterioration or malfunction from cause of humidity due to penetration of chemicals or water into camera's urea resins.
- As in the picture, it prevents temperature difference of camera (outside) and monitor (inside), and removes dew condensation caused by humidity of camera window.
- Camera must be installed when wall cement is completely dry.
- When product is installed in winter below -5°C, wait for approximately 2 hours to connect. Dew formation in monitor and camera due to temperature difference inside and outside may cause product defect.
- Avoid installing monitor and camera in place directly exposed to heat or where gas noxiousness is highly occurring.

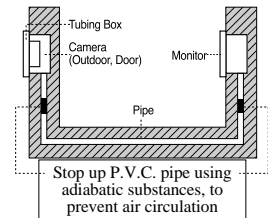

## Components of Product

### ■ Monitor Components

#### ■ Monitor [KCV-W354]

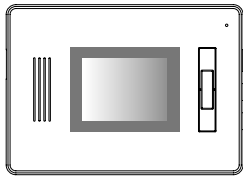

#### ■ DC 12V Adapter (PA-120150 SN) ※KCV-DW354



#### ■ A Wall Hanger Frame

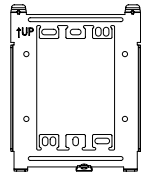

#### ■ Screw for fixing Monitor

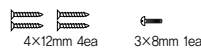

#### ■ Wire

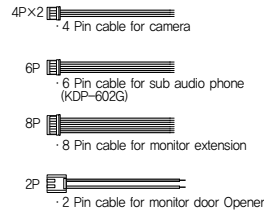

### ■ Door Camera Components

#### ■ Camera [KC-MC24]



#### ■ Main body supporter

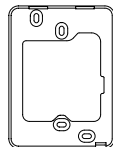

#### ■ Screws for fixing Camera

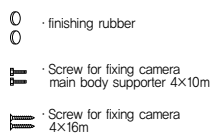

## Specifications

### ■ Specifications

	Model number	KCV-W354	KCV-DW354
	MONITOR	Power Source	SMPS AC100V-AC240V~
Power Consumption		Stand by 0.7W (±20%) , Max 13W (±20%)	
Operating Temperature		0°C ~ +40°C	
Communication System		Handsfree type	
LCD		3.5" Digital LCD (NTSC / PAL Auto switching)	
Wiring		Camera : 4 wire (Polarity) Sub audio phone : 6 wire (Polarity) Extension monitor : 8 wire (Polarity)	
Mount Type		Surface mount	
Dimension		195 (W) × 140 (H) × 34 (D) mm	
Camera connection	KC-MC24, KC-C60, KC-MC20, KC-MC30, KC-MC31		
DOOR CAMERA	Model number	KC-MC24	
	Power Source	DC 12V ± 2V (Power from Monitor)	
	Power Consumption	Max 3W (±20%)	
	Operating Temperature	-10°C ~ +50°C	
	Dimension	96 (W) × 127 (H) × 32 (D) mm	
	Angle of Lens	1/4", 3.43mm/F.NO2.5, 96.1°	

## Name and Functions of Each Part

### ■ The Front side

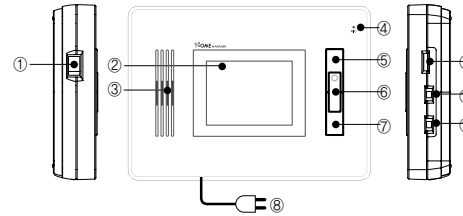

- ① **Power switch** : Use by turning AC power ON / OFF.
- ② **Monitor screen (LCD)** : Output of image sent from camera.
- ③ **Speaker**    ④ **Microphone**
- ⑤ **Monitor button** : Push this button to check around camera when inside, and image is shown for 60 seconds. (Voice intercepted between camera and monitor)
- ⑥ **Extension button or Speak button** : Use this button to start / stop speaking. On stanbying, the internal call is available with pressing the button for 1.5 second. The call is available with pressing the button when LCD screen is turned on.
- ⑦ **Open door button** : Use this button to open front door with connected door switch.
- ⑧ **Power cord** (In case of KCV-DW354, DC adaptor PA-120150 SN)
- ⑨ **Brightness adjustment volume** : Adjusting LCD screen brightness to use.

### ■ The Back side

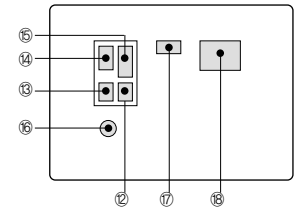

- ⑩ **Call volume adjustment switch** : Adjusting call sound in 3 steps [high, medium, low] to use. (In shipment : [medium])  
\* Cannot adjust call sound to "none".
- ⑪ **Speaking volume adjustment switch** : Adjust speaking volume transmitted from camera to monitor in 3 steps [high, medium, low] to use. (In shipment : [medium])
- ⑫ **Camera 1 terminal** : Connects camera 1 with 4 wire polarity.
- ⑬ **Camera 2 terminal** : Connects camera 2 with 4 wire polarity.
- ⑭ **Sub audio phone terminal** : Connects sub audio phone with 6 wire polarity
- ⑮ **Extension monitor terminal** : Connects extension monitor with 8 wire polarity
- ⑯ **Color adjustment volume** : Adjust color on LCD screen. (In shipment, adjusted to standard color)
- ⑰ **AC door switch terminal** : Connects AC door switch.
- ⑱ **Power input section** : Input AC or DC power and fix power cord.

### ■ Camera (KC-MC24)

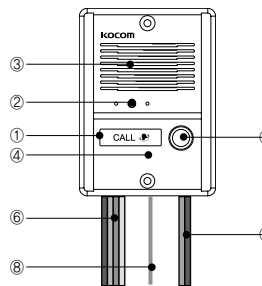

※ In case of camera KC-C60, KC-MC20, KC-30, and KC-MC31, please refer to the manual packed together with the camera

- ① **White LED diffusion** : Has built-in white LED that works at night and flickers when it gets dark around camera.
- ② **Camera section** : Converts camera surroundings to visual signal and deliver to monitor.
- ③ **Speaker**
- ④ **Microphone**
- ⑤ **Call button** : Push this button for output of call sound from monitor.
- ⑥ **Monitor connection wire** : 4 wires by polarity  
Blue : Vcc , Yellow : Ground , Red : Audio , White : Video
- ⑦ **DC door opener connection wire** : DC 2 wires by non-polarity
- ⑧ **FG** : Frame ground

## Installation Location

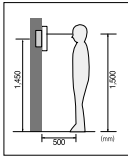

- **Monitor installation location**
- Standard monitor installation height is about 1,500mm where screen center is at eye level.
- In this case, wall-hanging metal center (center of piping) is 1,450mm above ground level.
- Standard installation height

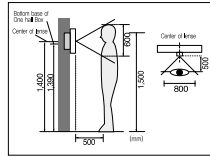

- **Camera installation location**
- Camera installation in height Standard camera installation height is when lens is about 1,400mm above the floor.
- In this case, camera stack center (piping box) is above 1,390mm above ground level.
- Standard installation in height

※The above angel of view is based on the KC-MC24 camera. The numbers vary according to the type of camera.

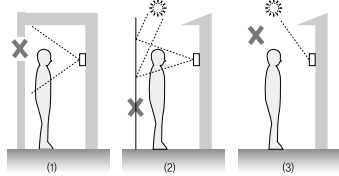

### ■ Caution of Camera installation

- Avoid installing camera exposed to direct ray of light (and sun).
- Beware backlight and darkness of visitor's face, which makes identification difficult.
- Avoid installing camera in places such as the following picture.
- (1) Place illuminating sky as background
- (2) Place with white wall reflecting direct ray of light
- (3) Place with direct ray of light

### ■ Monitor installation

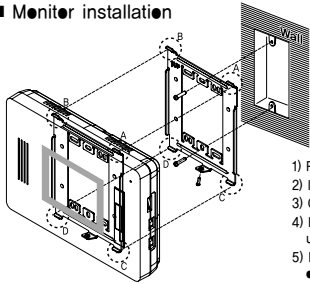

- 1) Remove wall-hanger bracket metal behind monitor.
- 2) Install wall-hanger bracket metal on 1 type box or wall with attached Vis.
- 3) Connect wiring to monitor back terminal referring to product connection diagram.
- 4) Hang monitor on wall-hanging metal, and fix monitor on wall-hanger bracket metal using attached Vis.
- 5) Plug monitor's power plug into consent and check to see if the power switch is [ON] on the left side of monitor.

### ■ Directly connecting cut-off power cord with power wire

- 1) Do not do such electric work on your own. Installing product in this way requires reliance on electric installation man with electric work license.
- 2) Insulate with insulating tape while cutting off power cord and connecting with power wire so electric wire metal does not expose. Contact between exposed electric wires cause fire or electric shock accident.
- 3) Such electric work requires connection after interception of supplied power.

## Product Connection Diagram

### ■ Name of Each Connection Port

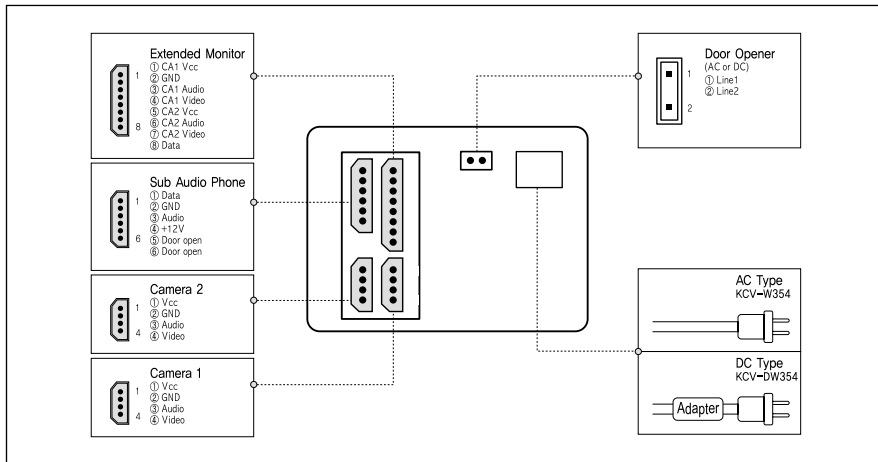

## Product Connection Diagram

### ■ Full System Configurations

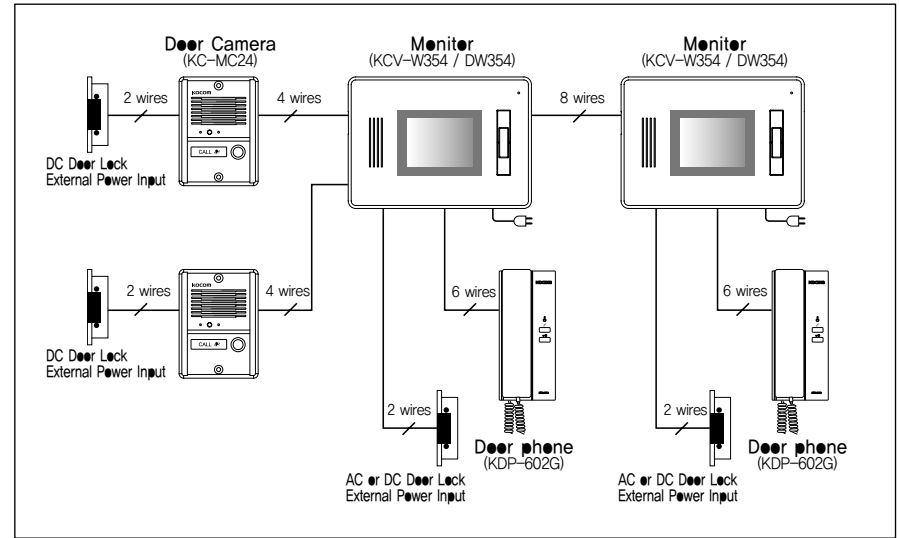

※ In case of camera KC-C60, KC-MC20, KC-30, and KC-MC31, please refer to the manual packed together with the camera

### ■ Camera Connection

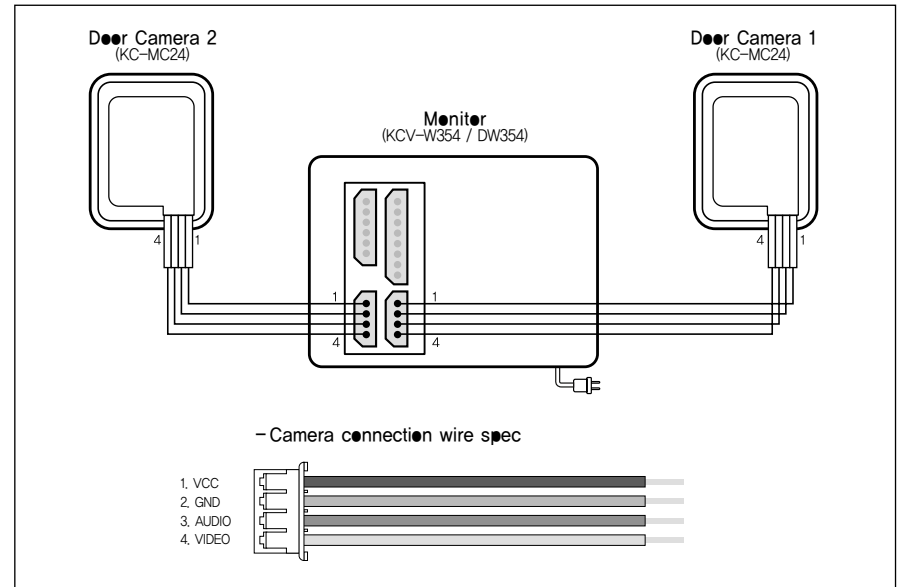

## Product Connection Diagram

### ■ Sub Audio Phone Connection

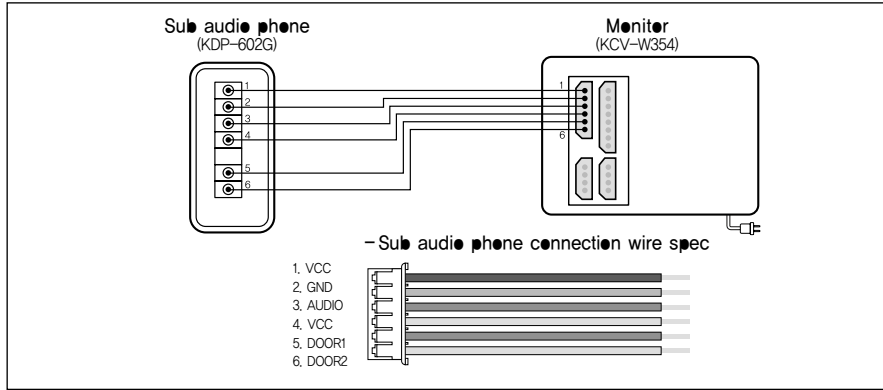

### ■ Ex\_Monitor Connection

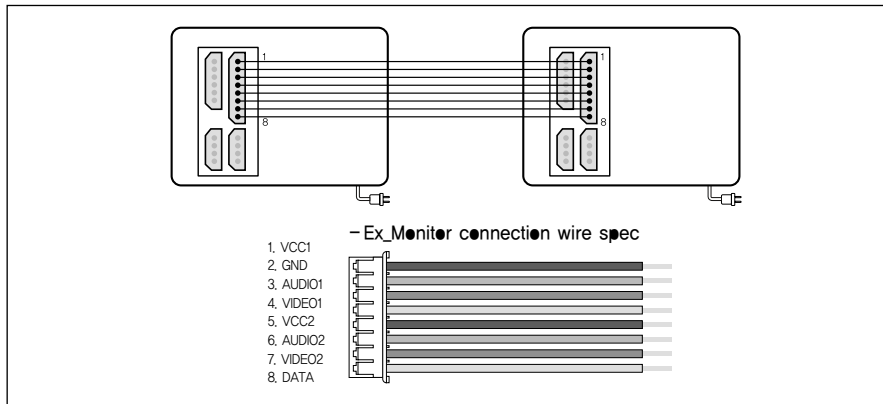

### ■ Door Lock Connection

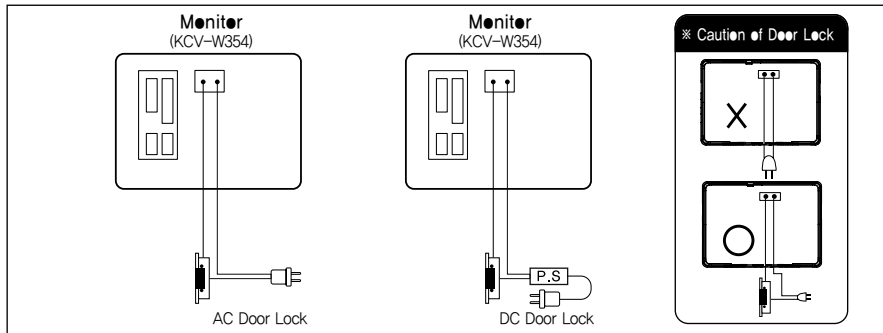

## Instructions for Operation

### ■ Communication with Door Camera

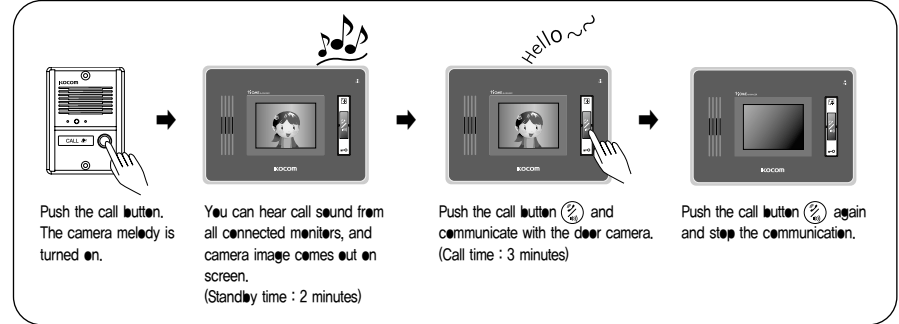

### ■ Camera Monitoring

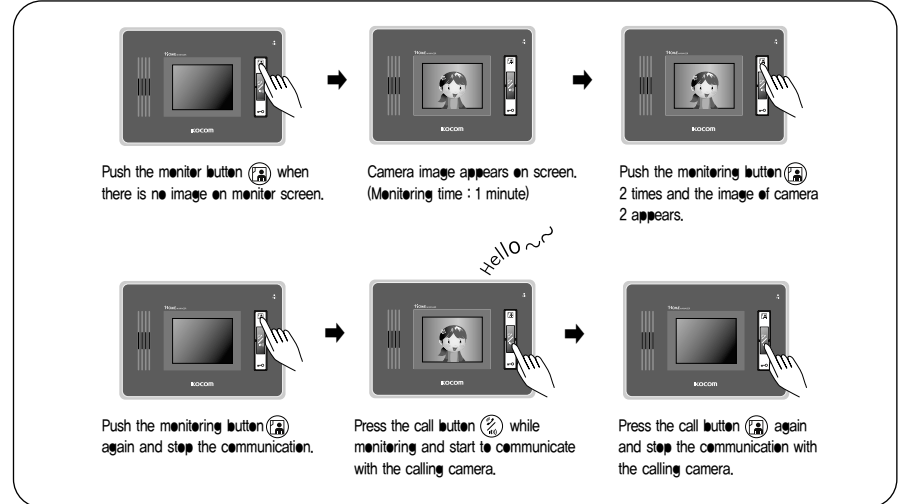

### ■ Opening Door Automatically

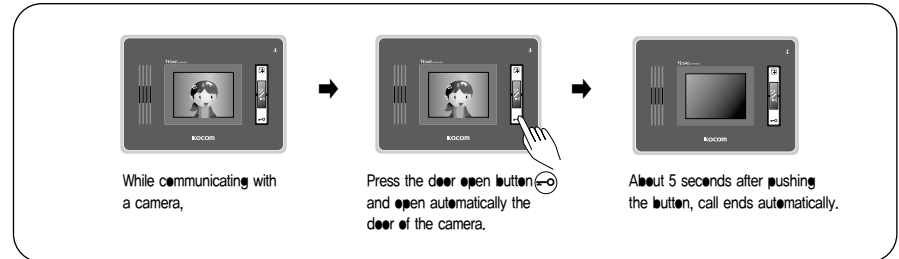

■ Extension Call & Communication

□ Internal Call Sending Mode

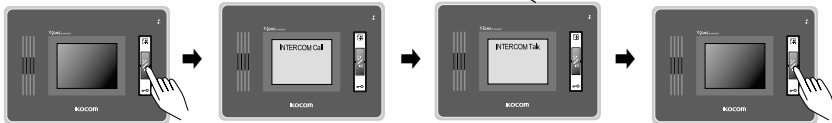

While the screen is off, push the call button (📞) for 1.5 second.

The screen turns on and 'INTERCOM Call' is written on OSD. (INTERCOM Call Standby time : 1 minute)

When connected to the sub-monitor and sub-audiophone, the main monitor will show 'INTERCOM Talk' on OSD and the communication turns on. (INTERCOM Talk time : 3 minutes)

Push the call button (📞) and stop INTERCOM Call.

□ Internal Call Receiving Mode



When receiving a call from sub-monitor and sub-audiophone, the main monitor shows 'INTERCOM Call' on OSD. (INTERCOM Call Standby time : 1 minute)

Push the call button (📞) and INTERCOM Talk starts.

Push the call button (📞) again and stop INTERCOM Talk.

※ Caution : Push the call button (📞) for 1.5 second.

■ Special Function Selection



When the screen off, push the monitor button (📺) for 4 seconds.

When the screen on, Menu Mode OSD appears with the cursor.

Menu Mode will disappear automatically in 30 seconds. Push the monitor button (📺) for 4 seconds and Menu Mode will turn off.

(MENU)  
 >>CAM1 : Bell 1 / 2 / 3 / 4 / 5  
 CAM2 : Bell 1 / 2 / 3 / 4 / 5  
 SUB : Bell 1 / 2 / 3 / 4 / 5  
 CAM1 View Time : 1MIN /  
 CAM2 View Time : 1MIN /

Menu for Special Function

Cursor Guide  
 · UP : Push the monitor button  
 · Selection : Push the call button  
 · Down : Push the door open button

■ Upto 100M : CAT5 cable

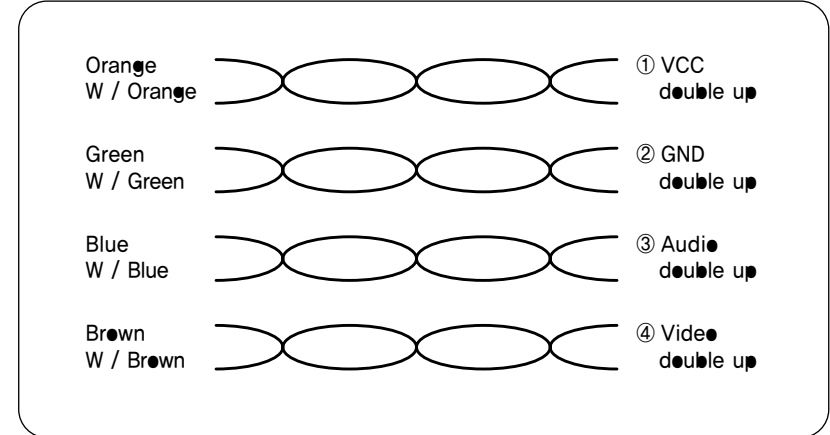

※ Based on distance from a camera to the monitor

※ CAT5 wire configuration

※ In case of more than 50m of CAT5 cable length, the screen and voice quality can get lower. But the symptom is not a kind of fault. So less than 50m is recommended.

■ Upto 50M : TIV 0.65mm<sup>2</sup> cable

■ Upto 100M : Over TIV 0.8mm<sup>2</sup> cable

■ Upto 150M : TIV 0.8mm<sup>2</sup> cable + RG-59 / U  
 RG-59 / U (Coaxial cable) for Video signal  
 (Connect core to Video & shield to GND)

※ According to outside environment, you may view the images somewhat unclear. However, they do not result from any defect or trouble of the product.